

Makita®

2023

SORTIMENT PRÍSLUŠENSTVA

Platnosť od 1. 4. 2023

do 30. 9. 2023



Sortiment aku strojov do záhrady

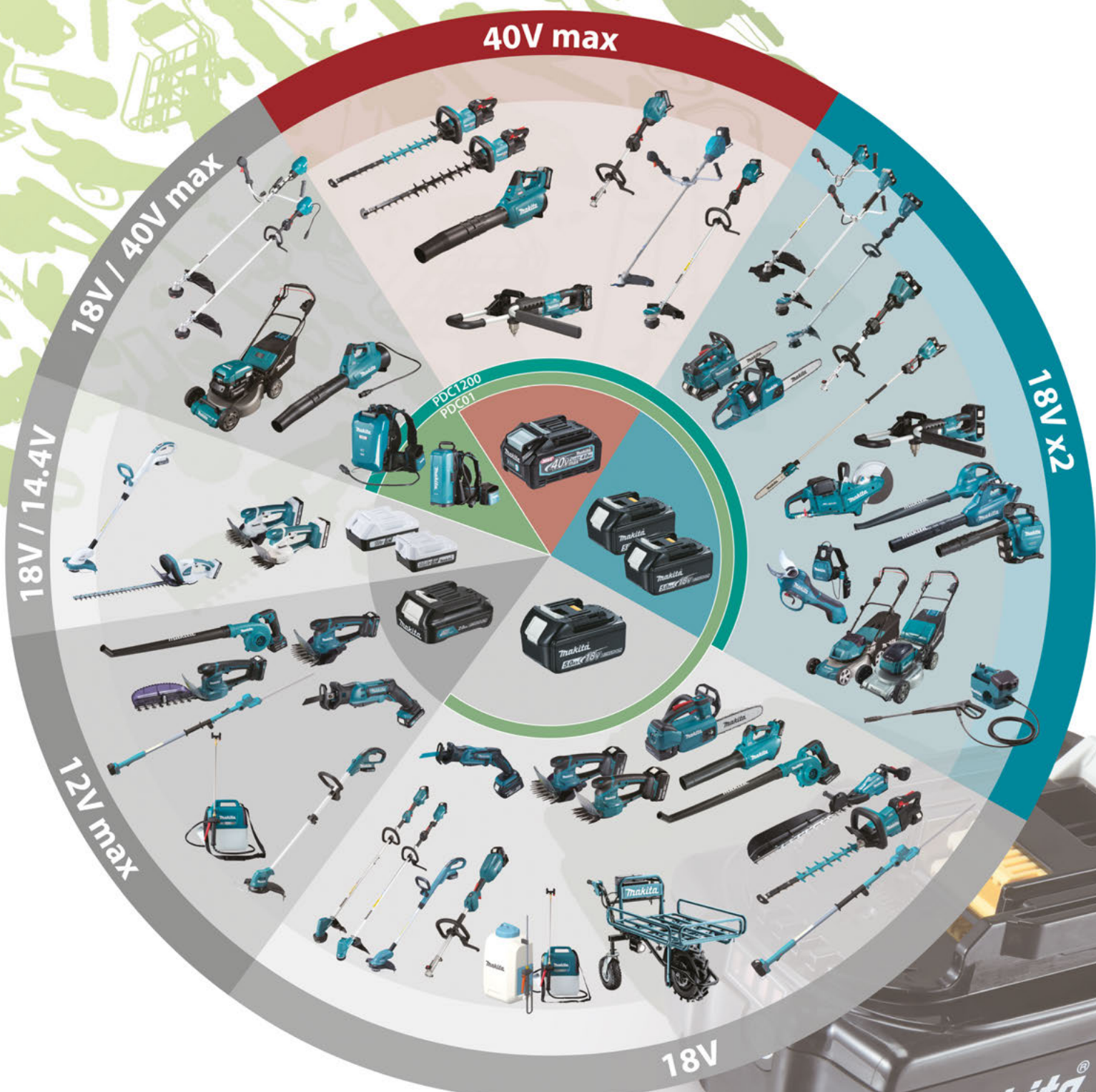

OBSAH

Akumulátory

Nabíjačky, sady akumulátorov, akumulátorové adaptéry, AC adaptéry pre rádia a ventilátory	7 – 11
--	--------

Odkladacie systémy

MAK PAC kufre	13 – 14
Kufre	15
Vnútra systainerov, tašky, opasky	16 – 20

Vrtanie

Kov	21 – 30
Sklo, murivo, kameň	31
Drevo	32 – 37
Vykružovacie korunky	39 – 44
Vrtáky s valcovitou stopkou betón, murivo, kameň	45 – 46
Príklepové vrtáky SDS-PLUS	48 – 52
Príklepové vrtáky SDS-MAX	53 – 54

Sekanie

Sekáče SDS-PLUS	55
Sekáče SDS-MAX	56
Sady sekáčov SDS-PLUS /	57
Sekáče rôzne upínania	58
Príslušenstvo pre vrtacie a sekacie kladivá, rukoväte, skľučovadlá, dorazy	59
Príslušenstvo k vrtáčkam, skľučovadlá, kľúče pre skľučovadlá	60 – 61
Príslušenstvo pre diamantové vrtanie DBM080/130/131/230	62 – 63

Skrutkovanie

Bity Impact PREMIER	66
Bity Impact BLACK	67
Bity, sady bitov	68 – 72

Príslušenstvo pre skrutkovače

Skrutky, bity	73 – 74
Príslušenstvo pre rázové uťahováky	75 – 76

Diamantové rezanie a brúsenie	78 – 82
----------------------------------	---------

Príslušenstvo pre nožnice na plech, závitových tyčí a roxorov	83
--	----

Rezné kotúče	84
--------------	----

Brúsne kotúče	85
---------------	----

Lamelové kotúče	87 – 89
-----------------	---------

Fibrové kotúče	90
----------------	----

Príslušenstvo pre Multi Tool	92 – 102
------------------------------	----------

Brúsne kely	104 – 109
-------------	-----------

Príslušenstvo pre uhlové brúsky, príruby, rukoväte, kľúče, odsávacie adaptéry, kryty kotúčov	110 – 111
---	-----------

Pílové kotúče

EFFICUT drevo	115
---------------	-----

EFFICUT železo	116
----------------	-----

EFFICUT WPC dosky	116
-------------------	-----

Makforce	117 – 118
----------	-----------

Makblade	119 – 120
----------	-----------

Špeciálne pre aku píly	121 – 122
------------------------	-----------

Na hliník	123
-----------	-----

Pre ponorné píly	124
------------------	-----

Na cementové dosky sendvičové panely	125
---	-----

Príslušenstvo pre kotúčové a pokosové píly dorazy, odsávacie adaptéry, vodiace lišty, adaptéry pre vodiace lišty	126 – 128
--	-----------

Stoly pod pokosové píly	129
-------------------------	-----

Príslušenstvo pre priamočiare a chvostové píly

Pílové listy	131 – 138
--------------	-----------

Príslušenstvo pre pásové píly	139 – 140
-------------------------------	-----------

Príslušenstvo pre hoblíky	141
---------------------------	-----

Frézovanie

Frézky	142 – 156
--------	-----------

Príslušenstvo pre frézy klieštiny, objímky	157 – 160
---	-----------

Brúsenie

Brúsne papiere	162 – 174
----------------	-----------

Príslušenstvo pre DSL800/801	174
------------------------------	-----

Príslušenstvo pre leštičky

Príslušenstvo pre vibračné brúsky	175 – 177
--------------------------------------	-----------

Príslušenstvo pre priame brúsky	178
---------------------------------	-----

Príslušenstvo pre dvojkotúčovú brúsku	179
--	-----

Príslušenstvo pre kefovú brúsku 9741	180
---	-----

Spony	181
-------	-----

Klince	182 – 184
--------	-----------

Príslušenstvo pre DCG180, DTR180, 181 DMP180, MP100, DGP180	185
---	-----

Príslušenstvo pre dierovač DPP200	186
--------------------------------------	-----

Príslušenstvo pre nitovačky DVR150, 250	187
--	-----

Aumulátorový ofukovač AF001G	188
------------------------------	-----

Lasery	188
--------	-----

Príslušenstvo elektrické vysávače	189
-----------------------------------	-----

Príslušenstvo pre tyčové vysávače	190
-----------------------------------	-----

Príslušenstvo pre podlahové a chrbtové aku vysávače	191 – 192
--	-----------

Adaptéry	193
----------	-----

Odsávacie adaptéry pre vrtacie a sekacie kladivá	194
---	-----

Pripojenie stroja k vysávačom	195 – 201
----------------------------------	-----------

Teplovzdušné pištole	202
----------------------	-----

Príslušenstvo pre lampy, aku kávovar	203
---	-----

Záhrada	204 – 243
---------	-----------

Ručné náradie	245 – 246
---------------	-----------

Ostatné príslušenstvo kufre, spony pre kufre	247 – 250
---	-----------

Uhlíky	251 – 253
--------	-----------





PIKTOGRAMY

 Drevo	 Profily	 Koža	 Odstraňovanie farby
 Drevo s klincami	 Nehrzdavejúca oceľ	 Vystužené vlákna	 Čistý rez
 Preglejka	 Neželezné kovy	 Vlnitý plech	 Dlhá životnosť
 Izolačné materiály	 Bi-metal	 Guma	 Zvárané laserom
 Laminátová podlaha	 Plexisklo	 Podložka	 Okružná píla
 Lepené drevo / škárovka	 Medené rúrky	 Izolačný materiál	 Ponorná píla
 Dosky z vlákniťého cementu	 PVC	 Nie je vhodný pre izolačné materiály	 Pokosová píla
 DVD dosky	 Sklo	 Čistý rez	 Skracovacia píla
 Lepené podlahy drevené	 Keramické obklady	 Hrubý rez	 Stolová píla
 DVD dosky	 Tehla	 Krivý rez	 Vibračná brúska
 MDF	 Tehla / kameň	 Rovný rez	 Vibračná brúska
 Palety	 Duté tehly	 Pozdĺžny rez	 Pásová brúska
 Laminátová podlaha	 Vápenec	 Priečny rez	 Benzínová rozbrusovačka
 Sendvičové panely	 Železobetón	 Dierovaný brúsny papier	 Excentrická brúska
 Kov / oceľ	 Betón	 Brúsny papier	 Uholová brúska
 Hliník	 Pórobotón	 Suchý zip	 Delta brúska
 Kov / mäkká oceľ	 Polystyrén	 Štetec	 Uholová brúska
 1/2 BSP Fitting	 5/4 UNC	 Používať na sucho	 Používať s vodou
 Nepoužívať režim kladiva	 Pre kladivá SDS-PLUS	 Pre kladivá SDS-MAX	

Akumulátory Lithium-Ion

	Model	Obj. č.	MOC s DPH		Model	Obj. č.	MOC s DPH
XGT 40 V max akumulátory					XGT 40 V max sady akumulátorov		
	BL4080F 8,0 Ah	191X65-8	349,99 €		2 x BL4050F + DC40RB	191U13-9	666,79 €
	BL4050F 5,0 Ah	191L47-8	259,99 €		2 x BL4050F + DC40RA	191V35-5	635,39 €
	BL4040 4,0 Ah	632N72-7	199,99 €		4 x BL4040 + DC40RB	191U28-6	cena na vyžiadanie
	BL4040 4,0 Ah	191B26-6	209,99 €		2 x BL4040 + DC40RB	191U00-8	586,89 €
	BL4025 2,5 Ah	191B36-3	149,99 €		2 x BL4040 + DC40RA	191J97-1	526,49 €
	BL4020 2,0 Ah	632R35-7	119,99 €		2 x BL4025 + DC40RA	191J81-6	405,19 €
	BL4020 2,0 Ah	191L29-0	134,99 €		LXT 18 V sady akumulátorov		
LXT 18 V akumulátory					4 x BL1860B + DC18RD	198091-4	586,89 €
	BL1860B 6,0 Ah	632F69-8	109,99 €		2 x BL1860B + DC18RD	198077-8	379,59 €
	BL1850B 5,0 Ah	632F15-1	99,99 €		4 x BL1850B + DC18RD	197626-8	568,89 €
	BL1830B 3,0 Ah	632G12-3	69,49 €		2 x BL1850B + DC18RD	197629-2	376,29 €
	BL1820 2,0 Ah	632F01-2	71,69 €		8 x BL1850B	199697-1	864,99 €
	BL1815N 1,5 Ah	196235-0	60,99 €		1 x BL1830B + DC18RC	197629-2	376,29 €
XGT nabíjačky					LXT nabíjačky		
	DC40RB dvojportová rýchlonabíjačka	191N09-8	191,29 €		DC18SF štvorportová nabíjačka	196426-3	212,59 €
	DC40RA jednoportová rýchlonabíjačka	191E07-8	129,99 €		DC18RD dvojportová rýchlonabíjačka	630868-6	144,49 €
Preносný napájací zdroj PDC1200					DC18SH dvojportová nabíjačka	199687-4	141,59 €
	Preносný napájací zdroj so zabudovanou batériou s kapacitou 1200 Wh, 33,5 Ah a napätím 36 V – 40 V max. Dodávané s nabíjačkou DC4001 a s adaptérom 2 x 18 V 191J51-1	PDC1200A01	1 825,79 €		DC18RC jednoportová rýchlonabíjačka	195584-2	61,99 €
					DC18RE LXT/CXT dvojportová rýchlonabíjačka	198720-2	cena na vyžiadanie
					DC18SE jednoportová nabíjačka do auta	194621-9	98,79 €
					DC18SD jednoportová nabíjačka	194533-6	56,29 €



AKUMULÁTORY: AKUMULÁTORY, NABÍJAČKY

Akumulátory Lithium-Ion

Model	Obj. č.	MOC s DPH
LXT14,4 V akumulátory		
 BL1430B 3,0 Ah	197615-3	76,89 €
 BL1415N 1,5 Ah	196875-4	61,09 €
CXT nabíjačky		
 DC10SB jednoportová nabíjačka	197363-4	56,29 €
G – séria nabíjačka		
 DC18WA jednoportová nabíjačka	195423-6	30,39 €
LXT 7,2 V		
BL7010 1,3 Ah	198000-3	39,29 €
Silikónový kryt akumulátorov		
BL1016, BL1021B	413E99-0	cena na vyžiadanie
BL1041B	413F00-1	cena na vyžiadanie
BL1815N, BL1820B	459937-2	cena na vyžiadanie
BL1830B, BL1840B, BL1850B, BL1860B	459938-0	cena na vyžiadanie
BL4020, BL4025	413E96-6	cena na vyžiadanie
BL4040	413E97-4	cena na vyžiadanie
BL4050F	413E98-2	cena na vyžiadanie

Model	Obj. č.	MOC s DPH
CXT 12 V max akumulátory		
 BL1041B 4,0 Ah	197406-2	64,99 €
 BL1021B 2,0 Ah	197396-9	44,89 €
BL1021B 2,0 Ah	632F59-1	36,59 €
 BL1016B 1,5 Ah	197393-5	33,09 €
G – séria		
 BL1815G 18 V 1,5 Ah	198186-3	52,39 €
BL1415G 14,4 V 1,5 Ah	198192-8	46,89 €
LXT 10,8 V		
 BL1013 1,3 Ah	196066-7	36,49 €
LXT 7,2 / 10,8 V nabíjačka		
DC10WA jednoportová nabíjačka	194588-1	36,79 €
Atrapy / kryty kontaktov akumulátorov		
Atrapa BL1041B CXT	Z74144-2	cena na vyžiadanie
Atrapa BL1860B LXT	Z86060-0	cena na vyžiadanie
Atrapa BL4040 XGT	Z74152-0	18,59 €
Kryt akumulátor XGT	412393-7	0,29 €
Kryt akumulátor LXT	450128-8	0,29 €
Kryt akumulátor CXT	456128-6	0,40 €

LI-ION AKUMULÁTORY A NABÍJAČKY

40Vmax		18V		Fast Charging DC40RA DC40RB*		DC40RC	Fast Charging DC40RA + ADP10 Kompatibilné s LXT		DC40RC + ADP10 Kompatibilné s LXT		Fast Charging DC18RC DC18RD* DC18RE**		DC18SF Except BL1430A		DC18SD DC18SH* DC18SE (Automotive)	
XGT 40Vmax Lithium-ion	8,0Ah BL4080F	76min.	170min.	-	-	-	-	-	-	-	-	-	-	-	-	-
	5,0Ah BL4050F	50min.	85min.	-	-	-	-	-	-	-	-	-	-	-	-	-
	4,0Ah BL4040	45min.	67min.	-	-	-	-	-	-	-	-	-	-	-	-	-
	2,5Ah BL4025	28min.	38min.	-	-	-	-	-	-	-	-	-	-	-	-	-
	2,0Ah BL4020	22min.	30min.	-	-	-	-	-	-	-	-	-	-	-	-	-
LXT 18V Lithium-ion	6,0Ah BL1860B	-	-	40min.	85min.	55min.	1 do 2 aku 130 min.	3 do 4 aku 260 min.	130min.	-	-	-	-	-	-	-
	5,0Ah BL1850B	-	-	35min.	70min.	45min.	110 min.	220 min.	110min.	-	-	-	-	-	-	-
	4,0Ah BL1840B	-	-	29min.	58min.	36min.	90 min.	180 min.	90min.	-	-	-	-	-	-	-
	3,0Ah BL1830B	-	-	22min.	42min.	22min.	60 min.	120 min.	60min.	-	-	-	-	-	-	-
	2,0Ah BL1820B	-	-	24min.	33min.	24min.	45 min.	90 min.	45min.	-	-	-	-	-	-	-
	1,5Ah BL1815N	-	-	15min.	22min.	15min.	30 min.	60 min.	30min.	-	-	-	-	-	-	-
	-	-	-	-	-	-	-	-	-	-	-	-	-	-	-	-
CXT 12Vmax Lithium-ion	4,0Ah BL1041B	60min.	130min.	 40Vmax Lithium-ion 18V x2 Lithium-ion		 360min.		 40Vmax Lithium-ion 18V x2 Lithium-ion 18V Lithium-ion Možné použiť so 4 ks 18V LXT aku								
	2,0Ah BL1021B	30min.	70min.													
	1,5Ah BL1016	22min.	50min.													
64Vmax Lithium-ion	4,0Ah BL6440	120min.	10,8V Lithium-ion	1,3Ah BL1013	50min.	18V Lithium-ion	1,5Ah BL1415G BL1815G	70min.	80min.							
			7,2V Lithium-ion	1,5Ah BL0715	35min.		14,4V Lithium-ion	2,0Ah BL1420G BL1820G	90min.	105min.						

*DC40RB / DC18RD / DC18SH: Dvojnabíjačka

**DC18RE: CXT & LXT Duálna nabíjačka

AKUMULÁTORY: ADAPTÉRY A PRÍSLUŠENSTVO

ADAPTÉRY

ADAPTÉR ADP10 Adaptér ADP10 XGT nabíjačky pre LXT akumulátory	191C10-7 44,79 € (MOC s DPH)	ADAPTÉR 18 V ADP05 USB ADAPTÉR 18 V LXT pre nabíjanie mobilných zariadení	DECADP05 25,89 € (MOC s DPH)
ADAPTÉR ADP04 adaptér pre 24V	193947-6 43,49 € (MOC s DPH)	ADAPTÉR 2x18V na 36V BCV03 Adaptér 2x18V na 36V, nie je možné použiť pre akumulátory BL1815 a 36V krovinozrez	196809-7 84,49 € (MOC s DPH)
USB ADAPTÉR 12V Max CXT USB ADAPTÉR 12V Max CXT pre nabíjanie telefónov	ATAADP06 25,09 € (MOC s DPH)	Adaptér 1 x 40 V XGT	191N62-4 140,99 € (MOC s DPH)
ADAPTÉR 12V MAX Adaptér pre vyhrievané bundy / vesty CXT 12V MAX	YL00000003 27,79 € (MOC s DPH)	ADAPTÉR Adaptér pre PDC01, PDC1200 2x18V	191J51-1 cena na vyžiadanie (MOC s DPH)
ADAPTÉR 18V Adaptér pre vyhrievané bundy / vesty LXT 18V	YL00000004 30,69 € (MOC s DPH)	ADAPTÉR Adaptér pre PDC01 1x18V	191J50-7 120,49 € (MOC s DPH)
ADAPTÉR 12V MAX Adaptér pre chladiace bundy 12V MAX	GM00001605 30,79 € (MOC s DPH)	NABÍJAČKA DC4001 nabíjačka pre PDC1200	1912C9-7 cena na vyžiadanie (MOC s DPH)
ADAPTÉR 14,4 / 18V Adaptér pre chladiace bundy	GM00001607 32,79 € (MOC s DPH)	ADAPTÉR 40 V MAX Adaptér 40 V max XGT pre nabíjanie mobilných zariadení, 2 x USB port 5,0 V / 2,1 A	ADP001 39,99 € (MOC s DPH)
ADAPTÉR BTC05 Adaptér XGT pre tester batérií BTC04	191K30-9 79,29 € (MOC s DPH)		

Kapacita batérie sa meria v súlade so smernicou o batériách 2006/66 / ES a predpismi EÚ 11. 3. 2010. Li-ion IEC61960.

AKUMULÁTORY: ADAPTÉRY A PRÍSLUŠENSTVO

ADAPTÉR CXT 12V max

TD00000110

43,99 € (MOC s DPH)

Adaptér pre vyhrievané a chladiace bundy, s USB portom pre nabíjanie mobilných zariadení
DFV210, DFJ206, DFJ207, DFJ210, DFJ211, DFJ212, DFJ213, DFJ214, DFJ216, DFJ304, DFJ305, DFJ310, DFJ311, DFJ405, DFJ407, DFJ410, DFJ411, DFJ416, CV102D, DCV202, CJ105D, CJ106D, DCJ205, DCJ206, CB100D, DCB200, DFJ212A, DFJ213A, DFJ214A, DFJ216A, DFJ312A, DFJ416A, DFV210A, DFV214A, DFV215A



ADAPTÉR LXT 18 V

TD00000111

44,99 € (MOC s DPH)

Adaptér pre vyhrievané a chladiace bundy, s USB portom pre nabíjanie mobilných zariadení
DFV210, DFJ206, DFJ207, DFJ210, DFJ211, DFJ212, DFJ213, DFJ214, DFJ216, DFJ304, DFJ305, DFJ310, DFJ311, DFJ405, DFJ407, DFJ410, DFJ411, DFJ416, CV102D, DCV202, CJ105D, CJ106D, DCJ205, DCJ206, CB100D, DCB200, DFJ212A, DFJ213A, DFJ214A, DFJ216A, DFJ312A, DFJ416A, DFV210A, DFV214A, DFV215A



AC ADAPTÉR LAMPY, RÁDIA, VENTILÁTORY



DMR 106, DRM 108, DMR112	SE00000101	22,99 €
DMR110, MR003G	SE00000265	21,99 €
DMR114, DMR115, MR002G, MR004G, MR006G, MR007G	SE00000679	35,19 €
DMR200, DMR202	SE00000501	12,99 €
DMR203	SE00000792	15,39 €
MR001G, DMR107, BMR100	SE00000078	23,39 €
CF002G	TE00000442	cena na vyžiadanie
DCF300	TE00000442	cena na vyžiadanie
DMR300, DMR301	TC00000137	76,39 €

Makpac systainery

Inteligentný spôsob ukladania strojov a príslušenstva. Systém spojovacích systainerov MakPac sa skladá zo štyroch výškovo odlišných systainerov, troch systainerov na náradie, dvoch chladiacich systainerov a dvoch transportných vozíkov. Púzdra môžu byť ukladané na seba a uzamknuté spolu s uzamykacími západkami. K dispozícii sú tiež vložky pre vaše náradie a príslušenstvo.

Prepojené systainery zaberajú menej úložného priestoru a ľahko sa prepravujú na pracovisko a z neho.



MAKPAC

<p>Typ 1</p> <p>396 × 296 × 105 mm PCV</p>	<p>821549-5 36,79 € (MOC s DPH)</p>  	<p>Typ 2</p> <p>396 × 296 × 157 mm PVC</p>	<p>821550-0 47,39 € (MOC s DPH)</p>  
<p>Typ 3</p> <p>396 × 296 × 210 mm PVC</p>	<p>821551-8 46,49 € (MOC s DPH)</p>  	<p>Typ 4</p> <p>396 × 296 × 315 mm PVC</p>	<p>821552-6 63,79 € (MOC s DPH)</p>  
<p>Typ 3 chladiaci box</p> <p>396 × 296 × 210 mm PVC objem 11L Kompatibilné s Makpac ramenným popruhom</p>	<p>198254-2 114,19 € (MOC s DPH)</p>   <p>11L 350ml x15 500ml x10 2000ml x2</p>	<p>Typ 4 chladiaci box</p> <p>396 × 296 × 210 mm PVC objem 18L Kompatibilné s Makpac ramenným popruhom</p>	<p>198253-4 127,29 € (MOC s DPH)</p>   <p>18L 350ml x30 500ml x20 2000ml x4</p>
<p>Penová vložka systainera</p>	<p>198978-0 8,33 € (MOC s DPH)</p> 	<p>Držiak systainera na VC4210</p> <p>Pre vysávač VC4210M</p>	<p>W107418357 33,59 € (MOC s DPH)</p>   
<p>Typ 1 s organizérmí 13 ks</p> <p>396 × 296 × 105 mm PCV</p>	<p>191X80-2 84,39 € (MOC s DPH)</p> 	<p>Sada krabičiek</p> <p>Sada krabičiek pre systainer typ 1</p> <ul style="list-style-type: none"> 50 × 50 mm 1 ks 50 × 100 mm 1ks 100 × 100 mm 1 ks 100 × 150 mm 1ks 150 × 150 mm 1 ks 	<p>191X92-5 16,39 € (MOC s DPH)</p>

MAKPAC

Typ 3 so 4 zásuvkami P-84311 200,59 € (MOC s DPH)

396 × 296 × 210 mm



Typ 3 so 6 zásuvkami P-84333 214,59 € (MOC s DPH)

396 × 296 × 210 mm



Klip na kufr 453974-8 0,76 € (MOC s DPH)

pre všetky typy systainerov



Vozík pre systainer P-83886 136,29 € (MOC s DPH)

transportný vozík na štyroch otočných kolieskach, aretácia na dvoch kolieskach, klipy na zaistenie systainera





Typ 3 s 12 zásuvkami P-84327 231,59 € (MOC s DPH)

396 × 296 × 210 mm



Typ 4 s 5 zásuvkami P-84349 270,69 € (MOC s DPH)

396 × 296 × 315 mm





Popruh jednoramenný 196817-8 3,59 € (MOC s DPH)



Typ 4 P-83680 16,29 € (MOC s DPH)

vhodný pre systainery typ 1, 2, 3, 4

Vozík pre systainer TR00000001 222,29 € (MOC s DPH)

transportný skladací vozík s kolieskami a zaistovacím popruhom



Taška pre RT0700 831327-5 56,69 € (MOC s DPH)

410 × 350 × 310 mm
odolná taška na náradie, vnútorné prepážky pre nástavce, popruh na rameno



KUFRE PRE STROJE MAKITA

Obj. č.	Model	Materiál	MOC s DPH	Obj. č.	Model	Materiál	MOC s DPH
---------	-------	----------	-----------	---------	-------	----------	-----------



Kufre pre akumulátorové stroje			
824572-9	4322, 4323, 4324, 4327, 4329	PVC	23,39 €
824809-4	4350 / 4351 CT/FCT	PVC	23,79 €
193196-5	5903R	PVC	89,39 €
824985-4	9554 / 9555 / 9558 / GA4530 / 5030	PVC	23,09 €
182875-0	9557 / 9558NB kovový	PVC	40,99 €
824806-0	BO4555 / 4556 / 4565 / 4557	PVC	15,09 €
824562-2	BO5030 / 5031 / 5041	PVC	22,99 €
824757-7	BSS 610 / 611	PVC	27,59 €
158597-4	DDF / DHP / 442 / 446 / 452 / 459 / 480 / 484; DTD129	PVC	20,89 €
140354-4	DDF / DHP 441 / 454 / 453 / 454 / 456	PVC	43,69 €
141856-3	DDF083; DDF / DHP 446 / 456 / 482; DTD152 / 153 / 155; DTW181 / 190	PVC	21,89 €
158777-2	DDF343 / 453	PVC	23,89 €
821661-1	DF / HP031 / 032 / 033 / 331 / 332 / 333; TD110 / 111; TW060 / 141 / 160 / 161	PVC	15,19 €
824981-2	DF457DWE / HP457; TD126 / 127	PVC	18,39 €
141257-5	DGA450 / 452	PVC	23,99 €
821717-0	DGA700 / 701 / 900 901	PVC	50,49 €
821840-1	DGP180	PVC	59,39 €
141643-0	DHR241	PVC	34,19 €
142551-8	DHR263 / 264	PVC	72,09 €
141354-7	DJR141 / 181	PVC	25,29 €
821620-5	DJR186 / 187 / 360	PVC	30,89 €
141486-0	DJV140 / 180	PVC	38,89 €
824650-5	DP4011; HP2050 / 2051 / 2070 / 2071; HR1830 / 2020 / 2021 / 2440 / 2450	PVC	15,69 €
141353-9	DSS610 / 611	PVC	28,79 €
141205-4	DTP140; DTS13; DTW152 / 250 / 251	PVC	27,99 €
AS0VP007MK	DVP180	Hliník	101,49 €
824890-5	FS2300 / 2500 / 2700 / 2701 / 4000 / 4300 / 6300	PVC	17,29 €
824958-7	GA7020 / 7030 / 7040 / 9020 / 9030 / 9040	PVC	45,89 €
824905-8	HM0870C	PVC	53,39 €

Kufre pre akumulátorové stroje			
143519-7	HM1203C / 1205C	PVC	92,99 €
824908-2	HM1213C	PVC	79,99 €
824897-1	HM1317C / CB	PVC	196,49 €
821839-6	HM1501 / 1502	PVC	105,59 €
824799-1	HR2230 / 2460 / 2470	PVC	36,99 €
821775-6	HR2300 / 2600 / 2630	PVC	40,89 €
140402-9	HR2610	PVC	20,49 €
140404-5	HR2610T	PVC	37,59 €
824789-4	HR2800/ 2810 / 2811, HK1820	PVC	20,89 €
824798-3	HR4002	PVC	41,39 €
821663-7	HS301D	PVC	24,19 €
141736-3	HS6101 / 7101	PVC	90,89 €
824555-9	HS6101, HS7101, 5603R, 5703R, 5705R	PVC	80,19 €
824964-2	HS6101, HS7101, 5603R, 5703R, 5705R	PVC	58,19 €
821796-8	JR001G	PVC	41,69 €
824993-5	JR100 / 102	PVC	19,09 €
821662-9	JR103D / 105D	PVC	22,19 €
821621-3	JR3050T / 3060T / 3070CT	PVC	19,09 €
824998-5	JV0600	PVC	15,79 €
821508-9	JV100D	PVC	20,49 €
824892-1	KP0800	PVC	19,29 €
824786-0	KP0810	PVC	50,59 €
824984-6	Kufor kombinovaný pre uhl. brúsky 230 mm /125 mm	PVC	65,09 €

Akumulátory
 Odkladacie systémy
 Vrtanie
 Skrutkovanie
 Brúsky
 Pílenie
 Frézovanie
 Brúsenie
 Klince / spony
 Špeciálne stroje
 Vysávanie
 Fény/lampy
 Záhrada
 Ručné náradie
 Ostatné

KUFRE: VNÚTRA SYSTEMEROV

Model	Typ systainera	Vnútro	MOC s DPH	Model	Typ systainera	Vnútro	MOC s DPH	Model	Typ systainera	Vnútro	MOC s DPH
4327	1	837803-7	5,09 €	3710	2	837674-2	7,96 €	DDF484	2	837916-4	4,90 €
4329	1	837803-7	5,09 €	6906	2	838024-4	cena na vyžiadanie	DDF485	2	837916-4	4,90 €
6413	1	838030-9	5,89 €	9046	2	838025-2	9,39 €	DDF486	2	837916-4	4,90 €
191J81-6	1	835G74-2	2,89 €	BDA340	2	838040-6	8,63 €	DDF487	2	837670-6	cena na vyžiadanie
2 x aku XGT 2,5Ah + DC40RA				DF002G	2	835U77-0	cena na vyžiadanie				
191J97-1	1	835G74-2	2,89 €	BDA341	2	838040-6	8,63 €	DF333D	2	835F02-1	cena na vyžiadanie
2 x aku XGT 4Ah + DC40RA				DFN350	2	835B51-4	cena na vyžiadanie				
197952-5	1	838110-1	13,19 €	BDA350	2	838040-6	8,63 €	DFS250	2	837805-3	8,18 €
4 x aku LXT + DC18RC				BDF343	2	837863-9	6,34 €				
199697-1	1	839742-7	3,79 €	BDF441	2	837916-4	4,90 €	DFS251	2	837805-3	8,18 €
8 x aku LXT				BDF446	2	837916-4	4,90 €				
4350CT	1	837803-7	5,09 €	BDF448	2	837916-4	4,90 €	DFS441	2	837805-3	8,18 €
4350FCT	1	837803-7	5,09 €	BDF451	2	837916-4	4,90 €	DFS451	2	837805-3	8,18 €
4350T	1	837803-7	5,09 €	BDF453	2	837863-9	6,34 €	DFS452	2	837805-3	8,18 €
4351CT	1	837803-7	5,09 €	BDF456	2	837863-9	6,34 €	DGA450	2	837632-8	6,67 €
4351FCT	1	837803-7	5,09 €	BDF458	2	837916-4	4,90 €	DGA452	2	837632-8	6,67 €
4351T	1	837803-7	5,09 €	BDF459	2	837916-4	4,90 €	DGD800	2	837806-1	8,21 €
DA3010F	1	837880-9	cena na vyžiadanie	BFS441	2	837805-3	8,18 €	DHP343	2	837863-9	6,34 €
DA3011F	1	837880-9	cena na vyžiadanie	BFS451	2	837805-3	8,18 €	DHP441	2	837916-4	4,90 €
DA330D	1	837695-4	cena na vyžiadanie	BHP343	2	837863-9	6,34 €	DHP444	2	837916-4	4,90 €
DA331D	1	837695-4	cena na vyžiadanie	BHP441	2	837916-4	4,90 €	DHP446	2	837863-9	6,34 €
DA332D	1	839304-1	cena na vyžiadanie	BHP446	2	837916-4	4,90 €	DHP448	2	837916-4	4,90 €
DA333D	1	839304-1	cena na vyžiadanie	BHP448	2	837916-4	4,90 €	DHP451	2	837916-4	4,90 €
DCO180	1	838062-6	cena na vyžiadanie	BHP451	2	837916-4	4,90 €	DHP453	2	837863-9	6,34 €
DF010D	1	837871-0	cena na vyžiadanie	BHP453	2	837863-9	6,34 €	DHP454	2	837916-4	4,90 €
DF030D	1	837866-3	7,42 €	BHP456	2	837863-9	6,34 €	DHP456	2	837916-4	4,90 €
DF031D	1	838312-9	4,19 €	BHP458	2	837916-4	4,90 €	DHP458	2	837916-4	4,90 €
DF032D	1	838312-9	4,19 €	BHP459	2	837916-4	4,90 €	DHP459	2	837916-4	4,90 €
DF033D	1	838312-9	4,19 €	BJV140	2	837639-4	8,20 €	DHP470	2	837916-4	4,90 €
DF330D	1	837866-3	7,42 €	BJV180	2	837639-4	8,20 €	DHP480	2	837863-9	6,34 €
DF331D	1	838312-9	4,19 €	BO3711	2	838028-6	5,92 €	DHP481	2	837916-4	4,90 €
DF332D	1	838312-9	4,19 €	BO4555	2	838029-4	4,89 €	DHP482	2	837916-4	4,90 €
DF333D	1	838312-9	4,19 €	BO4558	2	838029-4	4,89 €	DHP483	2	837670-6	cena na vyžiadanie
DP2010	1	838030-9	5,89 €	BO4565	2	838029-4	4,89 €	DHP484	2	837916-4	4,90 €
DP2011	1	838030-9	5,89 €	BO4566	2	838029-4	4,89 €	DHP485	2	837916-4	4,90 €
DP4003	1	838039-1	7,02 €	BO4900V	2	837675-0	7,06 €	DHP486	2	837916-4	4,90 €
DP4011	1	838039-1	7,02 €	BO4901	2	837675-0	7,06 €	DHP487	2	837670-6	cena na vyžiadanie
DP4011	1	838039-1	7,02 €	BO5031	2	837874-4	11,48 €	DJR143	2	837897-2	6,86 €
DP4700	1	837872-8	cena na vyžiadanie	BO5041	2	837874-4	11,48 €	DJR145	2	837897-2	6,86 €
FS2300	1	838030-9	5,89 €	BPT350	2	837640-9	7,79 €	DJR183	2	837897-2	6,86 €
FS2500	1	838030-9	5,89 €	BPT351	2	837640-9	7,79 €	DJR185	2	837897-2	6,86 €
FS2700	1	838030-9	5,89 €	BST110	2	837640-9	7,79 €	DJV140	2	837639-4	8,20 €
FS4000	1	838030-9	5,89 €	BST220	2	837640-9	7,79 €	DJV142	2	837639-4	8,20 €
FS4300	1	838030-9	5,89 €	BST221	2	837640-9	7,79 €	DJV180	2	837639-4	8,20 €
FS6300	1	838030-9	5,89 €	BTD129	2	837670-0	5,92 €	DJV182	2	837639-4	8,20 €
HP1630	1	837666-1	cena na vyžiadanie	BTD134	2	837670-0	5,92 €	DPT350	2	837640-9	7,79 €
HP1631	1	837666-1	cena na vyžiadanie	BTD136	2	837670-0	5,92 €	DPT351	2	837640-9	7,79 €
HP1640	1	837666-1	cena na vyžiadanie	BTD146	2	837670-0	5,92 €	DPT353	2	839128-5	8,66 €
HP1641	1	837666-1	cena na vyžiadanie	BTD147	2	837670-0	5,92 €	DPV300	2	835V03-5	cena na vyžiadanie
HP1641F	1	837666-1	cena na vyžiadanie	BTP130	2	837670-0	5,92 €	DST110	2	837640-9	7,79 €
HP2050	1	838039-1	7,02 €	BTP131	2	837670-1	cena na vyžiadanie	DST111	2	838582-0	cena na vyžiadanie
HP2051	1	838039-1	7,02 €	BTP140	2	837670-2	cena na vyžiadanie	DST112	2	838582-0	cena na vyžiadanie
HP2051	1	838039-1	7,02 €	BTP141	2	837670-3	cena na vyžiadanie	DST220	2	837640-9	7,79 €
HP2051F	1	838039-1	7,02 €	BTS130	2	837670-4	cena na vyžiadanie	DST221	2	837640-9	7,79 €
HP2070	1	838039-1	7,02 €	BTW250	2	837670-5	cena na vyžiadanie	DTD129	2	837670-6	cena na vyžiadanie
HP2071	1	838039-1	7,02 €	BTW251	2	837670-6	cena na vyžiadanie	DTD134	2	837670-6	cena na vyžiadanie
HP2071F	1	838039-1	7,02 €	DBO140	2	837809-5	8,18 €	DTD136	2	837670-6	cena na vyžiadanie
HP330D	1	837866-3	7,42 €	DBO180	2	837809-5	8,18 €	DTD137	2	837670-6	cena na vyžiadanie
HP331D	1	838312-9	4,19 €	DBO480	2	8351G2-0	cena na vyžiadanie	DTD146	2	837670-6	cena na vyžiadanie
HP332D	1	838312-9	4,19 €	DBO481	2	8351G2-0	cena na vyžiadanie	DTD147	2	837670-6	cena na vyžiadanie
HP333D	1	838312-9	4,19 €	DBO482	2	8351G2-0	cena na vyžiadanie	DTD148	2	837670-6	cena na vyžiadanie
JN1601	1	837882-5	4,89 €	DBS180	2	835P86-9	cena na vyžiadanie	DTD152	2	837670-6	cena na vyžiadanie
JR100D	1	837664-5	cena na vyžiadanie	DCO181	2	835R73-0	cena na vyžiadanie	DTD153	2	837670-6	cena na vyžiadanie
JR102D	1	837664-5	cena na vyžiadanie	DDA340	2	838040-6	8,63 €	DTD154	2	837670-6	cena na vyžiadanie
JR103D	1	838313-7	5,32 €	DDA341	2	838040-6	8,63 €	DTD155	2	837670-6	cena na vyžiadanie
JR105D	1	838313-7	5,32 €	DDA350	2	838040-6	8,63 €	DTD156	2	837670-6	cena na vyžiadanie
JS1000	1	838027-8	5,89 €	DDA350	2	838040-6	8,63 €	DTD157	2	837670-6	cena na vyžiadanie
JS1601	1	838027-8	5,89 €	DDA351	2	838040-6	8,63 €	DTD170	2	837670-6	cena na vyžiadanie
JS1602	1	837882-5	4,89 €	DDF083	2	837670-6	cena na vyžiadanie	DTD171	2	837670-6	cena na vyžiadanie
JV0600	1	837803-7	5,09 €	DDF343	2	837863-9	6,34 €	DTD172	2	837670-6	cena na vyžiadanie
JV100D	1	837665-3	cena na vyžiadanie	DDF441	2	837916-4	4,90 €	DTL060	2	837644-1	cena na vyžiadanie
JV101D	1	838563-4	6,55 €	DDF444	2	837916-4	4,90 €	DTL061	2	837644-1	cena na vyžiadanie
JV102D	1	839186-1	6,44 €	DDF446	2	837863-9	6,34 €	DTL062	2	837644-1	cena na vyžiadanie
JV103D	1	839186-1	6,44 €	DDF446	2	837916-4	4,90 €	DTL063	2	837644-1	cena na vyžiadanie
ST113D	1	839019-0	cena na vyžiadanie	DDF448	2	837916-4	4,90 €	DTP131	2	837670-6	cena na vyžiadanie
TD021D	1	837871-0	cena na vyžiadanie	DDF451	2	837916-4	4,90 €	DTP140	2	837670-6	cena na vyžiadanie
TD022D	1	837871-0	cena na vyžiadanie	DDF453	2	837863-9	6,34 €	DTP141	2	837670-6	cena na vyžiadanie
TD090D	1	837866-3	7,42 €	DDF453	2	837916-4	4,90 €	DTS130	2	837670-6	cena na vyžiadanie
TD110D	1	838312-9	4,19 €	DDF454	2	837916-4	4,90 €	DTS131	2	837670-6	cena na vyžiadanie
TD111D	1	838312-9	4,19 €	DDF456	2	837863-9	6,34 €	DTS141	2	837670-6	cena na vyžiadanie
TL064D	1	839287-5	cena na vyžiadanie	DDF458	2	837916-4	4,90 €	DTW180	2	837670-6	cena na vyžiadanie
TL065D	1	839287-5	cena na vyžiadanie	DDF459	2	837863-9	6,34 €	DTW181	2	837670-6	cena na vyžiadanie
TW0200	1	837869-7	cena na vyžiadanie	DDF470	2	837916-4	4,90 €	DTW190	2	838550-3	5,19 €
TW060D	1	838312-9	4,19 €	DDF480	2	837863-9	6,34 €	DTW250	2	837670-6	cena na vyžiadanie
TW100D	1	837866-3	7,42 €	DDF481	2	837916-4	4,90 €	DTW251	2	837670-6	cena na vyžiadanie
TW140D	1	838312-9	4,19 €	DDF482	2	837863-9	6,34 €	DTW280	2	837670-6	cena na vyžiadanie
TW141D	1	838312-9	4,19 €	DDF483	2	837670-6	cena na vyžiadanie	DTW281	2	837670-6	cena na vyžiadanie
TW160D	1	838312-9	4,19 €								
TW161D	1	838312-9	4,19 €								
WR100D	1	835C72-2	cena na vyžiadanie								

KUFRE: VNÚTRA SYSTAINEROV

Model	Typ systainera	Vnútro	MOC s DPH
DTW284	2	837670-6	cena na vyžiadanie
DTW285	2	837670-6	cena na vyžiadanie
DTW285	2	837670-6	cena na vyžiadanie
DTW300	2	835L10-8	cena na vyžiadanie
DTW301	2	835L10-8	cena na vyžiadanie
DTW302	2	835L10-8	cena na vyžiadanie
DWD181	2	RN32741155	cena na vyžiadanie
DWR180	2	835T86-3	cena na vyžiadanie
GA5030	2	837920-3	4,39 €
GA5040	2	837672-6	5,40 €
GA5040C	2	837672-6	5,40 €
GA5040R	2	837672-6	5,40 €
HP002G	2	835U77-0	cena na vyžiadanie
HR140D	2	839245-1	6,09 €
HR166D	2	839245-1	6,09 €
HR2300	2	837651-4	5,74 €
HR2600	2	837651-4	5,74 €
HR2601	2	837651-4	5,74 €
HR2630	2	837651-4	5,74 €
HR2631F	2	837651-4	5,74 €
HR2631FT	2	837651-4	5,74 €
HR2811F	2	837868-9	4,79 €
HR2811FT	2	837868-9	4,79 €
HR3001C	2	835B26-3	cena na vyžiadanie
HS300D	2	837662-9	cena na vyžiadanie
HS301D	2	838315-3	cena na vyžiadanie
JN3201	2	837630-2	cena na vyžiadanie
JS3201	2	837630-2	cena na vyžiadanie
191V35-5 2 x aku XGT 5,0 Ah + DC40RA	2	835X86-7	cena na vyžiadanie
RP0900	2	837646-7	5,60 €
RP0910	2	837660-3	7,50 €
RP1110C	2	837660-3	7,50 €
RP1111C	2	837660-3	7,50 €
SC103D	2	835E29-5	cena na vyžiadanie
TD001G	2	835F94-0	cena na vyžiadanie
TM3000C	2	837673-4	7,27 €
TM3010C	2	837773-0	21,06 €
TM30D	2	838612-7	6,29 €
TW004G	2	835R29-3	cena na vyžiadanie
TW005G	2	835R29-3	cena na vyžiadanie
TW0350	2	837870-2	cena na vyžiadanie

DRV150	3	835A34-8	cena na vyžiadanie
DRV250	3	835A34-8	cena na vyžiadanie
DSC102	3	839527-1	4,57 €
DSD180	3	838542-2	6,99 €
DSS500	3	837628-9	5,79 €
DSS501	3	837628-9	5,79 €
DSS610	3	837642-5	7,92 €
DTM40	3	837671-8	6,23 €
DTM41	3	837671-8	6,23 €
DTM50	3	837671-8	6,23 €
DTM51	3	837671-8	6,23 €
DTM52	3	835W93-4	4,69 €
DTW1001	3	837645-9	5,60 €
DTW1002	3	837645-9	5,60 €
DTW450	3	837645-9	5,60 €
DTW700	3	837645-9	5,60 €
DTW701	3	837645-9	5,60 €
DTW800	3	837645-9	5,60 €
FN001G	3	835U86-9	cena na vyžiadanie
HP001G	3	835F93-2	cena na vyžiadanie
HS6601	3	838314-5	5,53 €
KP001G	3	8354R2-5	cena na vyžiadanie
KP0800	3	837659-8	8,20 €
KP0810	3	837659-8	8,20 €
KP0810C	3	837659-8	8,20 €
4 x LXT 18 V akumulátory + DC18RD	3	839205-3	6,31 €
PJ7000	3	837661-1	4,88 €
191U00-8 2 x XGT aku 4,0 Ah + DC40RB	3	835W98-4	cena na vyžiadanie
191U13-9 2 x XGT aku 5,0 Ah + DC40RB	3	835W98-4	cena na vyžiadanie
191U28-6 4 x XGT aku 5,0 Ah + DC40RB	3	835W98-4	cena na vyžiadanie
SD100D	3	839016-6	cena na vyžiadanie
TW001G	3	835K85-1	5,09 €
TW007G	3	835K85-1	5,09 €
TW008G	3	835K85-1	5,09 €

Model	Typ systainera	Vnútro	MOC s DPH
1911B	3	837878-6	5,49 €
9403	3	837652-2	9,55 €
9404	3	837653-0	5,34 €
9741	3	838026-0	7,49 €
9902	3	837877-8	8,84 €
9903	3	837877-8	8,84 €
9910	3	837658-0	8,64 €
9911	3	837658-0	8,64 €
9920	3	837877-8	8,84 €
BCS550	3	837628-9	5,79 €
BHR162	3	838109-6	7,90 €
BHR202	3	837634-4	6,78 €
BHR241	3	837641-7	7,06 €
BJN160	3	837678-4	7,91 €
BJN161	3	837678-4	7,91 €
BKP180	3	837808-7	8,18 €
BO6030	3	837654-8	5,24 €
BO6040	3	837655-6	cena na vyžiadanie
BPJ140	3	837648-3	8,18 €
BPJ180	3	837648-3	8,18 €
BSS500	3	837628-9	5,79 €
BSS501	3	837628-9	5,79 €
BSS610	3	837642-5	7,92 €
BTM40	3	837671-8	6,23 €
BTM50	3	837671-8	6,23 €
BTW450	3	837645-9	5,60 €
CC300D	3	837879-4	cena na vyžiadanie
CC301D	3	838568-4	cena na vyžiadanie
DBO380	3	8351P0-7	6,29 €
DBO381	3	8351P0-7	6,29 €
DCC500	3	835U78-8	4,39 €
DCC501	3	835U78-8	4,39 €
DCS550	3	837628-9	5,79 €
DCS551	3	838269-4	7,63 €
DCS552	3	837628-9	5,79 €
DCS553	3	839751-6	3,99 €
DF001G	3	835F93-2	cena na vyžiadanie
DFR452	3	835Y86-3	cena na vyžiadanie
DFR551	3	835Y86-3	cena na vyžiadanie
DGA454	3	838175-3	5,18 €
DGA504	3	838175-3	5,18 €
DGA505	3	838175-3	5,18 €
DGA506	3	838175-3	5,18 €
DGA508	3	838175-3	5,18 €
DGA511	3	839252-4	6,29 €
DGA512	3	839252-4	6,29 €
DGA513	3	839252-4	6,29 €
DGA514	3	839252-4	6,29 €
DGA517	3	839252-4	6,29 €
DGA518	3	839252-4	6,29 €
DGA519	3	839252-4	6,29 €
DHR162	3	838109-6	7,90 €
DHR164	3	838109-6	7,90 €
DHR165	3	838109-6	7,90 €
DHR171	3	839387-1	4,62 €
DHR202	3	837634-4	6,78 €
DHR241	3	837641-7	7,06 €
DHS660	3	839752-4	4,39 €
DHS661	3	839752-4	4,39 €
DHS680	3	838182-6	7,00 €
DJN160	3	837678-4	7,91 €
DJN161	3	837678-4	7,91 €
DJR188	3	839458-4	3,19 €
DJV141	3	837789-5	8,17 €
DJV181	3	837789-5	8,17 €
DJV184	3	8352U6-6	4,79 €
DKP180	3	837808-7	8,18 €
DKP181	3	835E27-9	2,79 €
DPJ140	3	837648-3	8,18 €
DPJ180	3	837648-3	8,18 €

Model	Typ systainera	Vnútro	MOC s DPH
4131	4	837894-8	cena na vyžiadanie
5604R	4	837657-2	14,79 €
BHR242	4	837649-1	7,18 €
BHR243	4	837649-1	7,18 €
BHR262	4	837650-6	9,70 €
BHR262T	4	837650-6	9,70 €
BHS630	4	837635-2	12,13 €
CA5000	4	838390-9	8,17 €
DHK180	4	835D35-4	cena na vyžiadanie
DHR182	4	839891-0	4,59 €
DHR242	4	837649-1	7,18 €
DHR243	4	837649-1	7,18 €
DHR263	4	838257-1	13,84 €
DHR264	4	838257-1	13,84 €
DHR280	4	839559-8	4,62 €
DHR281	4	839559-8	4,62 €
DHR282	4	839559-8	4,62 €
DHR282	4	839559-8	4,62 €
DHR283	4	839559-8	4,62 €
DHR283	4	839559-8	4,62 €
DHS630	4	837635-2	12,13 €
DHS710	4	837861-3	18,66 €
DHS782	4	835C85-3	4,49 €
DHS783	4	835C85-3	4,49 €
DSP600	4	839290-6	5,38 €
DSP601	4	839290-6	5,38 €
DRT50	4	837247-1	10,97 €
DTR180	4	835W33-2	cena na vyžiadanie
GA005G	4	835E79-0	3,78 €
GA008G	4	835E79-0	3,78 €
GA013G	4	835E79-0	3,78 €
GA016G	4	835E79-0	3,78 €
GA023G	4	835E79-0	3,78 €
GA026G	4	835E79-0	3,78 €
GA029G	4	835E79-0	3,78 €
GA032G	4	835E79-0	3,78 €
GA040G	4	835E79-0	3,78 €
GA041G	4	835E79-0	3,78 €
GA041G	4	835E79-0	3,78 €
GA043G	4	835E79-0	3,78 €
GA044G	4	835E79-0	3,78 €
GA046G	4	835E79-0	3,78 €
GA047G	4	835E79-0	3,78 €
HR001G	4	835C84-5	cena na vyžiadanie
HR002G	4	835C84-5	cena na vyžiadanie
HR003G	4	835C84-5	cena na vyžiadanie
HR004G	4	835C84-5	cena na vyžiadanie
HR2652	4	839975-4	cena na vyžiadanie
HR2653	4	839975-4	cena na vyžiadanie
HR2653T	4	839975-4	cena na vyžiadanie
HR3011FC	4	835B25-5	cena na vyžiadanie
HR3012FC	4	835B25-5	cena na vyžiadanie
HS003G	4	835K81-9	cena na vyžiadanie
HS004G	4	835K82-7	5,09 €
HS6101	4	837299-2	cena na vyžiadanie
HS7101	4	837299-2	cena na vyžiadanie
HS7601	4	838108-8	8,34 €
HS7611	4	839500-1	cena na vyžiadanie
N5900B	4	837873-6	6,26 €
RP1800	4	837647-5	6,47 €
RP1800F	4	837647-5	6,47 €
RP1803F	4	8352F0-3	cena na vyžiadanie
RP2300FC	4	837647-5	6,47 €
RP2303FC	4	8352F0-3	cena na vyžiadanie
RT001G	4	837247-1	10,97 €
RT0700C	4	837247-1	10,97 €
RT0702C	4	837247-1	10,97 €
SG1251	4	838111-9	4,49 €
SP001G	4	8351E4-2	cena na vyžiadanie
SP6000	4	838390-9	8,17 €

Držiaky náradia 3. generácie, technické riešenia



Systém remienkov na opasok s rýchlopúpnacími sponami na koncoch sa dajú ľahko oddeliť od tašiek na náradie a nosiť v páse ako ľahký opasok na náradie. Hodí sa na všetky vrecká a držiaky nástrojov.



3 LAYERS

3L Technológia je jedinečná trojvrstvá kombinácia polyesterov a peny, ktorá poskytuje ďalšie odpruženie. Navrhnuté tak, aby boli tvrdé a odolné voči poveternostným vplyvom. Tieto úžasne ľahké polypropylénové panely sú zložené z troch kompozitných vrstiev, ktoré sú bezpečne spojené do požadovaného tvaru. Inovatívna vlastnosť týchto štruktúrovaných materiálov umožňuje ich tvarovanie do ľubovoľného tvaru.



WATERPROOF BOTTOM

Vodeodolný materiál je vysoko kvalitné riešenie pre tašky na náradie, je pevné, odolné voči opotrebovaniu a vodotesné, takže udržuje náradie suché a chránené. Vystužený plastový podstavec vám pomôže udržiavať vak na náradie čistý.



REAL LEATHER

Pravá koža je zvonku hladká s brúseným semišom vo vnútri. Silná a odolná pre dlhú životnosť, s pridanou odolnosťou proti oderu. Koža bola vybraná pre použitie vo výrobkoch vyžadujúcich silnejšiu vrstvu – 1,8 až 2,0 mm – zabezpečenie produktu najvyššej kvality.

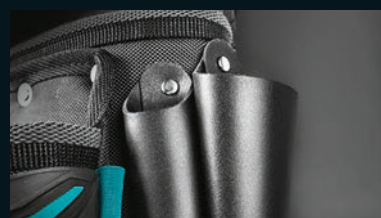

DURABLE RIVETING

Odolné silné nitovanie. Použitie silné jednodielne nity s podložkami pre extrémne namáhané spoje. Používajú sa podložky pre väčšiu pevnosť na strategických miestach na jednej alebo na oboch stranách, hore a dole.

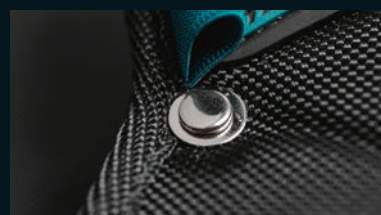

ANTI SLIP

Istiace prvky zabraňujú nechcenému vypadávaniu náradia s prepážok tašky a tým predchádzajú poškodeniu samotného náradia. Vysoko kvalitná polypropylénová páska má gumový povrch.



ELASTIC LOOPS

Elastické popruhy, dokonale zaisťujú náradie na svojom mieste proti svojvoľnému vypadnutiu. Elastické popruhy boli použité na širokú škálu našich produktov. Popruhy sa dokážu prispôsobiť tak, aby dokonale istili náradie a príslušenstvo.



SIDE-GATE SOLUTION

Klip systém, vám umožní ľahko vložiť nástroj bez toho, aby ste sa museli pozerieť kde máte otvor držiaka náradia. Ďalšia funkcia výkyvu zaisťuje, že váš nástroj je udržiavaný v pohodlnom uhle. Vyrobené z nehrdzavejúcej ocele.

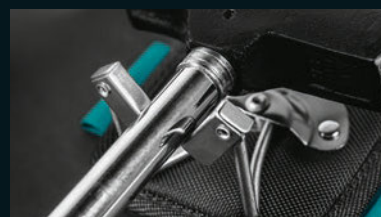







ODKLADACIE SYSTÉMY









Foto	Popis	Rozmery (mm)			STRAP / BELT SYSTEM	3 LAYERS	WATERPROOF BOTTOM	REAL LEATHER	DURABLE RIVETING	ANTI SLIP	ELASTIC LOOPS	SIDE-GATE SOLUTION	Obj. č.	MOC s DPH
		H	L	W										
	taška na skrutkovač	290	170	85	0	0	0	0	0	0	0	E-15154	24,98 €	
	taška na skrutkovač	235	155	75	0	0	0	0	0	0	0	E-15176	16,98 €	
	univerzálna taška na skrutkovač a príslušenstvo	270	260	145	0	0	0	0	0	0	0	E-15182	46,98 €	
	2 kombinácia taška Makita	270	260	145	0	0	0	0	0	0	0	E-15198	32,98 €	
	3 kombinácia taška Makita	270	320	145	0	0	0	0	0	0	0	E-15207	42,98 €	
	univerzálna taška pre pokrivačov	270	290	145	0	0	0	0	0	0	0	E-15213	46,98 €	
	3 kombinácia taška Makita + opasok	270	640	145	0	0	0	0	0	0	0	E-15229	96,98 €	
	opasok na ťažké náradie	310	880	170	0	0	0	0	0	0	0	E-15235	118,98 €	
	taška pre elektrikárov	310	250	125	0	0	0	0	0	0	0	E-15241	34,98 €	
	taška na kladivo a kladivo	185	180	105	0	0	0	0	0	0	0	E-15257	21,98 €	
	taška na kladivo	185	175	105	0	0	0	0	0	0	0	E-15263	21,98 €	
	taška pre elektrikárov	205	185	55	0	0	0	0	0	0	0	E-15279	21,98 €	
	taška na ručné náradie a kladivo	205	185	85	0	0	0	0	0	0	0	E-15285	21,98 €	
	držiak na kladivo	165	110	65	0	0	0	0	0	0	0	E-15300	15,19 €	
	taška na meter	165	110	80	0	0	0	0	0	0	0	E-15338	10,98 €	







Opasky

Foto	Popis	Rozmery (mm)			STRAP / BELT SYSTEM	3 LAYERS	WATERPROOF BOTTOM	REAL LEATHER	DURABLE RIVETING	ANTI SLIP	ELASTIC LOOPS	SIDE-GATE SOLUTION	Obj. č.	MOC s DPH
		H	L	W										
	opasok s bedrovým pásom pre ťažké náradie	100	880	30				O	O				E-15366	39,98 €
	opasok s rýchloupínacou sponou	50	1550	-									E-05337	14,98 €
	opasok na ťažké náradie	48	1380	-				O					E-15693	24,98 €
	opasok kožený čierny M	38	1130	-				O					E-05359	24,98 €
	opasok kožený čierny L	38	1330	-				O					E-05365	24,98 €
	opasok kožený hnedý M	38	1130	-				O					E-05371	24,98 €
	opasok kožený hnedý L	38	1330	-				O					E-05387	24,98 €
	popruhy na opasok E-05321, E-05175	410	520	23					O				E-15372	34,98 €
	traky Makita	-	50	-									E-05402	20,98 €

Tašky

Foto	Popis	Rozmery (mm)			STRAP / BELT SYSTEM	3 LAYERS	WATERPROOF BOTTOM	REAL LEATHER	DURABLE RIVETING	ANTI SLIP	ELASTIC LOOPS	SIDE-GATE SOLUTION	Obj. č.	MOC s DPH
		H	L	W										
	taška na náradie	310	510	300			O	O		O			E-15388	101,98 €
	taška na ťažké náradie	265	505	295			O		O	O			E-15394	cena na vyžiadanie
	taška na náradie otvorená	355	490	310			O	O		O			E-15403	70,98 €
	taška na náradie	250	440	240			O			O			E-15431	54,98 €
	taška na náradie	300	670	330			O	O		O			E-11782	95,98 €
	taška na náradie	380	700	360			O	O		O			831279-0	75,79 €
	taška na náradie	270	520	25		O			O	O			E-05496	128,98 €
	ruksak na náradie s organizérom	490	390	230			O			O			E-15481	65,98 €
	taška na píly	260	900	270			O			O			E-15512	76,98 €

Výbava

Foto	Popis	Rozmery (mm)			STRAP / BELT SYSTEM	3 LAYERS	WATERPROOF BOTTOM	REAL LEATHER	DURABLE RIVETING	ANTI SLIP	ELASTIC LOOPS	SIDE-GATE SOLUTION	Obj. č.	MOC s DPH
		H	L	W										
	puzdro na mobil	165	90	40			O	O			O		E-15556	16,98 €
	termo taška na potraviny	210	330	180			O						E-15584	27,98 €
	ochrana kolena mäkká	240	170	30									E-15615	27,98 €
	ochrana kolena gelová	240	170	95									E-05658	40,98 €
	taška na vodiacu lištu 1,4 - 1,5 m	220	1565	45		O							E-05664	45,98 €
	taška na vodiacu lištu 1 m	220	1070	45		O							E-05670	40,98 €

VŘTANIE: ŽELEZO

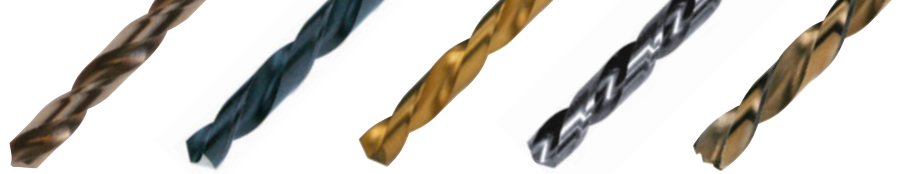

HSS VRTÁKY DO KOVU

HSS-R

HSS-G

Titánové
HSS-TIN

Kobalt
HSS-CO

M-Force

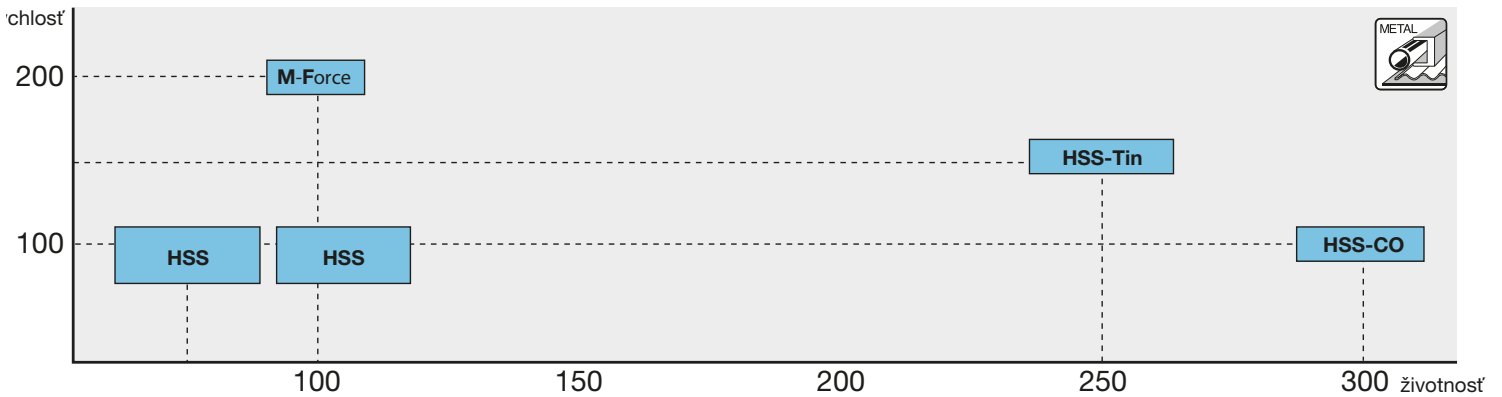

ø mm	L1 mm	L2 mm	ks/bal	Obj. č.	MOC s DPH
------	-------	-------	--------	---------	-----------

Vrták na vrtanie otvorov pre nity

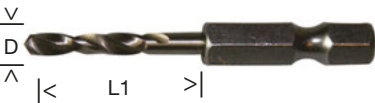

3,3	50	20	5	B-56437	10,49 €
-----	----	----	---	---------	---------

1/4 „stopkový vrták, ktorý je špeciálne navrhnutý na vrtanie otvorov pre nity. Ostrá špička pod uhlom 135 ° čo znamená, že tieto vrtáky vyvrtajú otvory dvojnásobnou rýchlosťou ako štandardný vrták s ostrejším stredovým bodom.



HSS-R Vrtáky do kovu z rýchloreznej ocele



1,5	40	18	1	D-09656	0,59 €
2	49	24	1	D-09662	0,79 €
2,5	57	30	1	D-09678	0,79 €
3	61	33	1	D-09684	0,79 €
3,5	70	39	1	D-09690	1,19 €
4	75	43	1	D-09709	1,39 €
4,5	80	47	1	D-09715	1,29 €
5	86	52	1	D-09721	1,79 €
5,5	93	57	1	D-09737	1,89 €
6	93	57	1	D-09743	2,09 €
7,5	109	69	1	D-09771	2,29 €
8	117	75	1	D-09787	3,99 €
8,5	117	75	1	D-09793	4,09 €
9	125	81	1	D-09802	4,19 €
9,5	125	81	1	D-09818	4,99 €
10	133	87	1	D-09824	6,69 €
10,5	133	87	1	D-09830	5,89 €
11	142	94	1	D-09846	7,19 €
12	151	101	1	D-09868	9,99 €
12,5	151	101	1	D-09874	8,29 €
13	151	101	1	D-09880	11,39 €

Tvrdený hrot HSS-R
Vrtáky s výbrusom vhodné pre železné a neželezné kovy, ktoré ponúkajú dobrú rýchlosť vrtania a predĺženú životnosť. Dostupné v priemeroch 1,5 mm – 13 mm



VŘTANIE: ŽELEZO

ø mm	L1 mm	L2 mm	ks/bal	Obj. č.	MOC s DPH
------	-------	-------	--------	---------	-----------

Vrtáky do kovov z rýchloreznej ocele (HSS)



Tvrdený hrot HSS-R

Vrtáky s výbrusom vhodné pre železné a neželezné kovy, ktoré ponúkajú dobrú rýchlosť vrtania a predĺženú životnosť.

Dostupné v priemeroch 1,5 mm – 13 mm



Sada vrtákov HSS 13 ks **D-54075** **8,49 €** (MOC s DPH)

1,5/2/2,5/3/3,2/3,5/4/4,5
4,8/5/5,5/6/6,5 mm

Sada vrtákov HSS 19 ks **D-54081** **17,09 €** (MOC s DPH)

1/1,5/2/2,5/3/3,5/4/4,5/5/5,5/
6/6,5/7/7,5/8/8,5/9/9,5/10 mm

1,50	40	18	10	D-06236	2,49 €
2,00	49	24	10	D-06258	3,39 €
2,25	53	27	10	D-06264	4,49 €
2,50	57	30	10	D-06270	3,79 €
2,75	61	33	10	D-06286	3,89 €
3,00	61	33	10	D-06292	5,39 €
3,50	70	39	10	D-06317	6,09 €
4,00	75	43	10	D-06339	7,69 €
4,25	75	43	10	D-06345	8,59 €
4,50	80	47	10	D-06351	9,89 €
4,75	80	47	10	D-06367	8,89 €
5,00	86	52	10	D-06373	16,59 €
5,50	93	57	10	D-06395	10,89 €
6,00	93	57	10	D-06410	16,19 €
6,50	101	63	10	D-06432	15,79 €
7,00	109	69	10	D-06454	15,19 €
8,00	117	75	10	D-06498	30,19 €
8,50	117	75	5	D-06513	14,59 €
9,00	125	81	5	D-06535	20,29 €
10,00	133	87	5	D-06579	25,69 €
10,50	133	87	5	D-06591	26,99 €
11,00	142	94	5	D-06600	33,69 €
12,00	151	101	5	D-06622	39,89 €
12,50	151	101	5	D-06638	33,99 €
13,00	151	101	5	D-06644	43,79 €

170 ks sada vrtákov do železa **D-30564** **264,19 €** (MOC s DPH)

1; 1,5; 2; 2,5; 3; 3,5;
4; 4,5; 5; 5,5 × 10 ks
6; 6,5; 7; 7,5; 8 × 10 ks
8,5; 9; 9,5; 10 × 5 ks

Vrták na vrtanie otvorov pre nity

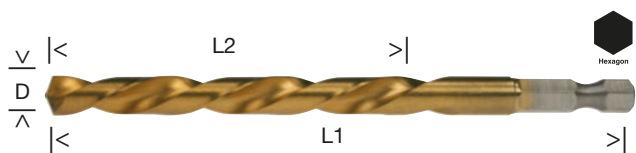

Vrtáky z úpravou Nitrid titánu pre predĺženú životnosť.

S 1/4" upínanie vhodné pre rýchloupínacie systémy a šesťhranné upínanie. Priemery od 3 – 13mm. Sady sú s valcovitou stopkou.



Sada vrtákov HSS – Tin 19 ks **D-72229** **22,49 €** (MOC s DPH)

1,5 × 2; 2 × 2; 2,5 × 2; 3 × 2; 3,2; 3,5
4; 4,5; 5; 5,5; 6; 6,5; 7; 8; 10

Sada vrtákov do kovu HSS-Tin 6 ks **D-72833** **6,39 €** (MOC s DPH)

Ø mm 2; 3; 4; 5; 6; 8

3	80	47	1	D-14928	1,59 €
3,2	85	52	1	D-14934	1,49 €
3,3	85	52	1	D-16081	1,39 €
4	95	57	1	D-14940	1,79 €
4,2	95	57	1	D-14956	1,89 €
5	105	65	1	D-14962	2,19 €
6	110	69	1	D-14978	2,79 €
8	115	75	1	D-15827	6,39 €
10	130	87	1	D-15833	7,99 €
12	150	101	1	D-15849	11,59 €
13	150	101	1	D-15855	13,39 €

Sada vrtákov HSS – Tin 13 ks **D-72855** **7,89 €** (MOC s DPH)

1,5 – 10 mm × 40 – 130 mm

Sada vrtákov HSS – Tin 10 ks **D-72849** **10,79 €** (MOC s DPH)

1; 2; 3; 4; 5; 6; 7;
8; 9; 10

VRTANIE: VRTÁKY DO KOVOV Z RÝCHLOREZNEJ OCELE (HSS)

ø mm	L1 mm	L2 mm	ks/bal	Obj. č.	MOC s DPH
------	-------	-------	--------	---------	-----------

Vrtáky do kovov HSS-Co 5 %

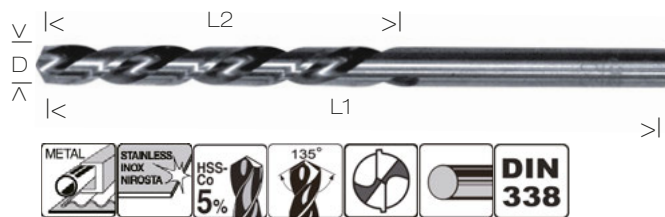

Kobaltové valcovitá stopka

Vrtáky HSS podľa DIN338 s oceľou M35 s obsahom 5% a 8% kobaltu. Toto znamená, že vrták je silnejší a v porovnaní so štandardnými vydrží dlhšie. Uhol špičky 118 ° znižuje riziko pošmyknutia vrtáka určené pre vrtanie do kvalitných ocelí, ťahaných alebo s veľkým obsahom zliatin. Použitie na mäkkú oceľ, nehrdzavejúcu oceľ a ťažko obrábatelné materiály, zvarané švy a práce na karosérii.

1,50	40	16	1	D-17289	0,89 €
2,00	49	24	1	D-17295	1,09 €
2,50	57	30	1	D-17304	0,99 €
3,00	61	33	1	D-17310	1,39 €
3,20	65	36	1	D-17326	cena na vyžiadanie
3,50	70	39	1	D-17332	1,39 €
4,00	75	43	1	D-17348	1,99 €
4,50	80	47	1	D-17354	2,39 €
5,00	86	52	1	D-17360	2,49 €
5,50	93	57	1	D-17376	2,29 €
6,00	93	57	1	D-17382	3,09 €
6,50	101	63	1	D-17398	3,09 €
7,00	109	69	1	D-17407	3,79 €
8,00	117	75	1	D-17429	5,39 €
9,00	125	81	1	D-17441	7,39 €
10,00	133	87	1	D-17463	9,59 €
12,00	151	101	1	D-17500	16,69 €

ø mm	L1 mm	L2 mm	ks/bal	Obj. č.	MOC s DPH
------	-------	-------	--------	---------	-----------



1,00	34		10	P-61416-10	6,29 €
1,50	40	16	10	P-61438-10	6,79 €
1,60	43	18	10	P-76087-10	7,59 €
2,00	49	24	10	P-61450-10	7,59 €
2,30	53	27	10	P-76146-10	8,89 €
2,40	57	30	10	P-76152-10	8,89 €
2,50	57	30	10	P-61472-10	8,89 €
2,60	57	30	10	P-76168-10	9,99 €
2,80	61	33	10	P-76180-10	9,99 €
2,90	61	33	10	P-76196-10	9,99 €
3,00	61	33	10	P-61494-10	9,99 €
3,20	65	36	10	P-76211-10	11,79 €
3,25	65	36	10	P-61503-10	12,09 €
3,40	70	39	10	P-76233-10	12,09 €
3,50	70	39	10	P-61519-10	12,09 €
3,75	70	39	10	P-61525-10	14,09 €
3,90	75	43	10	P-76277-10	14,09 €
4,00	75	43	10	P-61531-10	14,09 €
4,10	75	43	10	P-76283-10	15,39 €
4,20	75	43	10	P-76299-10	15,39 €
4,25	75	43	10	P-61547-10	16,39 €
4,30	80	47	10	P-76308-10	15,39 €
4,50	80	47	10	P-61553-10	15,39 €
4,60	80	47	10	P-76320-10	18,69 €
4,80	86	52	10	P-76342-10	18,69 €
4,90	86	52	10	P-76358-10	19,49 €
5,00	86	52	10	P-61575-10	19,49 €
5,10	86	52	10	P-76364-10	22,89 €



5,20	86	52	10	P-76370-10	22,89 €
5,25	86	52	10	P-61581-10	22,89 €
5,50	93	57	10	P-61597-10	22,89 €
5,90	93	57	10	P-76439-10	26,49 €
6,00	93	57	10	P-61612-10	26,49 €
6,10	101	63	10	P-76445-10	32,19 €
6,20	101	63	10	P-76451-10	32,19 €
6,30	101	63	10	P-76467-10	32,19 €
6,40	101	63	10	P-76473-10	32,19 €
6,60	101	63	10	P-76489-10	38,89 €
6,70	101	63	10	P-76495-10	38,89 €
6,80	109	69	10	P-76504-10	38,89 €
7,00	109	69	10	P-61656-10	38,89 €
7,30	109	69	10	P-76548-10	42,79 €
7,50	109	69	10	P-61678-10	42,79 €
8,00	117	75	10	P-61690-10	52,89 €
8,10	117	75	5	P-76607-5	29,09 €
8,20	117	75	5	P-76613-5	29,09 €
8,50	117	75	5	P-61715-5	29,09 €
9,00	125	81	5	P-61721-5	33,79 €
10,00	133	87	5	P-61743-5	42,59 €
10,50	133	87	5	P-61759-5	48,19 €
11,00	142	94	5	P-61765-5	55,49 €
11,50	142	94	5	P-61771-5	60,49 €
12,00	151	101	5	P-61787-5	68,09 €
12,50	151	101	5	P-61793-5	74,09 €
13,00	151	101	5	P-61802-5	79,99 €

VŘTANIE: VRTÁKY DO KOVOV Z RÝCHLOREZNEJ OCELE (HSS)

Vrtáky do kovov HSS-Co 5 %



DIN340, špička pod uhlom 130°



ø mm	L1 mm	L2 mm	ks/bal	Obj. č.	MOC s DPH
5,00	132	87	10	P-62826-10	46,19 €
13,00	205	155	5	P-62985-5	172,59 €

Vrtáky do kovov HSS-Co 8 % s valcovitou stopkou



DIN338, špička pod uhlom 130°



2,00	49	24	10	P-61880-10	13,59 €
2,50	57	30	10	P-61905-10	15,39 €
3,00	61	33	10	P-61927-10	16,29 €
3,50	70	39	10	P-61949-10	18,69 €
4,00	75	43	10	P-61961-10	22,09 €
4,25	75	43	10	P-61977-10	24,49 €
4,50	80	47	10	P-61983-10	24,49 €
5,00	86	52	10	P-62000-10	29,39 €
6,00	93	57	10	P-62044-10	40,49 €
6,50	101	63	10	P-62066-10	48,19 €
7,50	109	69	10	P-62094-10	64,19 €
8,00	117	75	10	P-62103-10	76,09 €
10,00	133	89	10	P-62147-5	64,49 €

Vrtáky do kovov HSS-TiN s valcovitou stopkou



DIN338, špička pod uhlom 130°



1,00	34		10	P-60981-10	4,89 €
1,50	40	16	10	P-61008-10	5,29 €
2,00	49	24	10	P-61020-10	5,89 €
2,50	57	30	10	P-61042-10	6,39 €
3,00	61	33	10	P-61064-10	8,29 €
3,25	65	36	10	P-61070-10	10,09 €
3,50	70	39	10	P-61086-10	10,09 €
4,00	75	43	10	P-61101-10	10,89 €
4,25	75	43	10	P-61117-10	13,09 €
4,50	80	47	10	P-61123-10	13,09 €
5,00	86	52	10	P-61145-10	15,89 €
5,50	93	57	10	P-61167-10	18,19 €
6,00	93	57	10	P-61189-10	21,09 €
6,50	101	63	10	P-61204-10	24,39 €
7,00	109	69	10	P-61226-10	28,99 €
7,50	109	69	10	P-61248-10	33,09 €
8,00	117	75	10	P-61260-10	38,09 €
8,50	117	75	5	P-61282-5	21,79 €
9,00	125	81	5	P-61298-5	24,79 €
10,00	133	87	5	P-61313-5	32,49 €
10,50	133	87	5	P-61329-5	35,99 €
12,00	151	101	5	P-61357-5	50,19 €
12,50	151	101	5	P-61367-5	53,99 €
13,00	151	101	5	P-61379-5	58,89 €

VŔTANIE: VRTÁKY DO KOVOV Z RÝCHLOREZNEJ OCELE (HSS)

ø mm	L1 mm	L2 mm	ks/bal	Obj. č.	MOC s DPH
------	-------	-------	--------	---------	-----------

Obojstranné vrtáky HSS-G



Vhodné na vytváranie otvorov pre nity a predvrtávanie závitov



2,00	38	7,5	10	B-26652	3,19 €
3,00	46	10,6	10	B-26668	5,09 €
3,10	49	11	10	B-26674	7,19 €
3,20	49	11	10	B-26680	5,89 €
3,30	49	11	10	B-26696	6,39 €
3,50	52	13	10	B-26705	6,99 €
3,80	55	14	10	B-26711	6,99 €
4,00	55	14	10	B-26727	7,09 €
4,10	55	14	10	B-26733	8,49 €
4,20	55	14	10	B-26749	10,29 €
4,30	55	14	10	B-26755	9,09 €
4,80	62	17	10	B-26777	10,39 €
4,90	62	17	10	B-26783	11,39 €
5,00	62	17	10	B-26799	9,89 €
5,10	62	17	10	B-26808	13,99 €
5,2	62	17	10	B-26814	13,29 €



- Akumulátory
- Odkladacie systémy
- Vŕtanie
- Skrutkovanie
- Brúsky
- Pílenie
- Frezovanie
- Brúsenie
- Klince / spony
- Špeciálne stroje
- Vysávanie
- Fény/lampy
- Záhradná
- Ručné náradie
- Ostatné

VRTANIE: VRTÁKY DO KOVŮV Z RÝCHLOREZNEJ OCELE (HSS)

ø mm	L1 mm	L2 mm	ks/bal	Obj. č.	MOC s DPH	ø mm	L1 mm	L2 mm	ks/bal	Obj. č.	MOC s DPH
------	-------	-------	--------	---------	-----------	------	-------	-------	--------	---------	-----------

Vrtáky do kovov HSS-G s valcovitou stopkou



1,00	34	12	10	P-60115-10	2,59 €	5,25	86	52	10	P-60280-10	13,99 €
1,10	36	14	10	P-75328-10	2,69 €	5,30	86	52	10	P-75661-10	13,99 €
1,20	38	16	10	P-75334-10	2,69 €	5,50	93	57	10	P-60296-10	13,99 €
1,25	38	16	10	P-60121-10	2,69 €	5,60	93	57	10	P-75683-10	15,29 €
1,30	38	16	10	P-75340-10	2,69 €	5,80	93	57	10	P-75708-10	15,29 €
1,40	40	18	10	P-75356-10	2,69 €	6,00	93	57	10	P-60311-10	16,39 €
1,50	40	18	10	P-60137-10	2,69 €	6,10	101	63	10	P-75720-10	15,39 €
1,60	43	20	10	P-75362-10	3,29 €	6,20	101	63	10	P-75736-10	15,39 €
1,70	43	20	10	P-75378-10	3,29 €	6,25	101	63	10	P-60327-10	15,39 €
1,75	46	22	10	P-60143-10	3,29 €	6,30	101	63	10	P-75742-10	15,39 €
1,80	46	22	10	P-75384-10	3,29 €	6,40	101	63	10	P-75758-10	15,39 €
1,90	46	22	10	P-75390-10	3,29 €	6,50	101	63	10	P-60333-10	15,89 €
2,00	49	24	10	P-60159-10	3,29 €	6,70	101	63	10	P-75770-10	17,79 €
2,10	49	24	10	P-75409-10	4,19 €	6,80	109	69	10	P-75786-10	17,79 €
2,20	53	27	10	P-75415-10	4,19 €	7,00	109	69	10	P-60355-10	17,79 €
2,30	53	27	10	P-75421-10	4,19 €	7,20	109	69	10	P-75817-10	19,99 €
2,40	57	30	10	P-75437-10	4,19 €	7,50	109	69	10	P-60377-10	19,99 €
2,50	57	30	10	P-60171-10	4,19 €	7,70	117	75	10	P-75851-10	22,09 €
2,60	57	30	10	P-75443-10	5,09 €	7,80	117	75	10	P-75867-10	22,09 €
2,70	61	33	10	P-75459-10	5,09 €	7,90	117	75	10	P-75873-10	22,09 €
2,80	61	33	10	P-75465-10	5,09 €	8,00	117	75	10	P-60399-10	22,09 €
2,90	61	33	10	P-75471-10	5,39 €	8,10	117	75	5	P-75889-5	12,89 €
3,00	61	33	10	P-60193-10	5,39 €	8,20	117	75	5	P-75895-5	12,89 €
3,10	65	36	10	P-75487-10	6,29 €	8,30	117	75	5	P-75904-5	12,89 €
3,20	65	36	10	P-75493-10	6,29 €	8,40	117	75	5	P-75910-5	12,89 €
3,25	65	36	10	P-60202-10	6,99 €	8,50	117	75	5	P-60414-5	13,19 €
3,30	65	36	10	P-75502-10	6,99 €	8,60	125	81	5	P-75926-5	15,09 €
3,40	70	39	10	P-75518-10	6,99 €	9,00	125	81	5	P-60420-5	15,89 €
3,50	70	39	10	P-60218-10	6,99 €	9,30	125	81	5	P-75982-5	cena na vyžiadanie
3,60	70	39	10	P-75524-10	7,99 €	9,50	125	81	5	P-60436-5	16,69 €
3,70	70	39	10	P-75530-10	7,99 €	9,70	133	87	5	P-76015-5	19,79 €
3,80	75	43	10	P-75546-10	7,99 €	9,80	133	87	5	P-76021-5	19,79 €
3,90	75	43	10	P-75552-10	7,99 €	9,90	133	87	5	P-76037-5	19,79 €
4,00	75	43	10	P-60230-10	7,99 €	10,00	133	87	5	P-60442-5	19,79 €
4,10	75	43	10	P-75568-10	8,89 €	10,50	133	87	5	P-60458-5	21,99 €
4,20	75	43	10	P-75574-10	8,89 €	11,00	142	94	5	P-60464-5	25,49 €
4,25	75	43	10	P-60246-10	9,99 €	11,50	142	94	5	P-60470-5	27,59 €
4,30	80	47	10	P-75580-10	9,99 €	12,00	151	101	5	P-60486-5	30,59 €
4,40	80	47	10	P-75596-10	9,99 €	12,50	151	101	5	P-60492-5	32,69 €
4,50	80	47	10	P-60252-10	9,99 €	13,00	151	101	5	P-60501-5	33,99 €
4,60	80	47	10	P-75605-10	11,49 €						
4,70	80	47	10	P-75611-10	11,49 €						
4,80	86	52	10	P-75627-10	11,49 €						
4,90	86	52	10	P-75633-10	12,29 €						
5,00	86	52	10	P-60274-10	12,29 €						
5,10	86	52	10	P-75649-10	13,99 €						
5,20	86	52	10	P-75655-10	13,99 €						

VŘTANIE: VRTÁKY DO KOVOV Z RÝCHLOREZNEJ OCELE (HSS)

ø mm	L1 mm	L2 mm	ks/bal	Obj. č.	MOC s DPH	ø mm	L1 mm	L2 mm	ks/bal	Obj. č.	MOC s DPH
------	-------	-------	--------	---------	-----------	------	-------	-------	--------	---------	-----------

Vrtáky do kovov HSS-G s valcovitou stopkou



2.0	125		1	P-63024	3,99 €	5,50	205		1	P-63236	12,49 €
2,50	140		1	P-63052	4,39 €	6,00	205		1	P-63264	12,49 €
3,00	150		1	P-63080	4,49 €	6,00	260		1	P-63270	18,49 €
3,00	190		1	P-63096	8,99 €	6,00	330		1	P-63286	24,69 €
3,50	165		1	P-63111	6,89 €	7,00	225		1	P-63323	14,89 €
3,50	265		1	P-63133	14,49 €	8,00	240		1	P-63389	16,79 €
4,00	175		1	P-63149	7,49 €	8,00	305		1	P-63395	26,09 €
4,00	220		1	P-63155	11,99 €	8,00	390		1	P-63404	40,29 €
4,50	185		1	P-63177	7,69 €	10,00	265		1	P-63507	26,29 €
5,00	195		1	P-63208	8,29 €	10,00	340		1	P-63513	36,89 €
5,00	245		1	P-63214	15,49 €	10,00	430		1	P-63529	51,89 €
5,00	315		1	P-63220	23,69 €	13,00	295		1	P-63688	39,49 €

Vrtáky do kovov HSS-GM2 s valcovitou stopkou



špička pod uhlom 130°

1,00	34	12	10	P-60545-10	4,79 €	6,00	93	57	10	P-60741-10	21,09 €
1,50	40	18	10	P-60567-10	5,19 €	6,00	139	91	10	P-62599-10	41,69 €
2,00	49	24	10	P-60589-10	5,59 €	6,50	101	63	10	P-60763-10	24,69 €
2,00	85	52	10	P-62511-10	11,59 €	6,50	148	99	10	P-62608-10	49,29 €
2,25	53	26	10	P-60595-10	6,09 €	7,00	109	69	10	P-60785-10	29,29 €
2,50	57	30	10	P-60604-10	6,09 €	7,00	156	105	10	P-62614-10	56,39 €
2,50	95	59	10	P-62527-10	12,39 €	7,50	109	69	10	P-60800-10	32,69 €
3,00	61	33	10	P-60626-10	7,69 €	8,00	117	75	10	P-60822-10	37,69 €
3,00	100	63	10	P-62533-10	14,89 €	8,00	165	115	10	P-62636-10	71,99 €
3,50	70	39	10	P-60648-10	9,49 €	8,50	117	75	5	P-60844-5	21,69 €
3,50	112	71	10	P-62549-10	18,79 €	8,50	165	115	5	P-62642-5	40,99 €
4,00	119	77	10	P-62555-10	21,09 €	9,00	125	81	5	P-60850-5	24,49 €
4,50	80	47	10	P-60682-10	13,09 €	9,50	125	81	5	P-60866-5	27,29 €
4,50	126	81	10	P-62561-10	24,19 €	10,00	133	87	5	P-60872-5	32,09 €
5,00	86	52	10	P-60707-10	16,69 €	10,00	184	134	5	P-62670-5	60,59 €
5,00	132	87	10	P-62577-10	30,59 €	10,50	133	87	5	P-60888-5	35,49 €
5,50	93	57	10	P-60729-10	18,59 €	11,00	142	94	5	P-60894-5	40,69 €
						12,00	151	101	5	P-60919-5	50,29 €
						12,50	151	101	5	P-60925-5	54,19 €
						13,00	151	101	5	P-60931-5	57,69 €

VRTANIE: VRTÁKY DO KOVOV Z RÝCHLOREZNEJ OCELE SADY

Sady vrtákov do kovov z rýchloreznej ocele (HSS-G)

Sada vrtákov HSS – G 19 ks **P-73673** **37,69 €** (MOC s DPH)

1; 1,5; 2; 2,5; 3; 3,5; 4; 4,5; 5; 5,5;
6; 6,5; 7; 7,5; 8,5; 9; 9,5; 10;
PVC obal



Sada vrtákov HSS – G 19 ks **P-60517** **29,29 €** (MOC s DPH)

1; 1,5; 2; 2,5; 3; 3,5; 4; 4,5; 5; 5,5;
6; 6,5; 7; 7,5; 8,5; 9; 9,5; 10;
Kovový obal



Sada vrtákov HSS – G 25 ks **P-73689** **73,49 €** (MOC s DPH)

1; 1,5; 2; 2,5; 3; 3,5; 4; 4,5; 5; 5,5;
6; 6,5; 7; 7,5; 8,5; 9; 9,5; 10; 10,5;
11; 11,5; 12; 12,5; 13;
PVC obal



Sada vrtákov HSS – G 25 ks **P-60523** **62,59 €** (MOC s DPH)

1; 1,5; 2; 2,5; 3; 3,5; 4; 4,5; 5; 5,5;
6; 6,5; 7; 7,5; 8,5; 9; 9,5; 10; 10,5;
11; 11,5; 12; 12,5; 13;
Kovový obal



Sada vrtákov s 1/4" upínaním 5 ks **D-20769** **16,19 €** (MOC s DPH)

5; 6; do dreva
5; 6; 8; HSS-Tin do kovu



Sada vrtákov s 1/4" upínaním 5 ks **D-23759** **12,79 €** (MOC s DPH)

5; 6; do dreva
5; 6; ; HSS-Tin do kovu
6; HN CT do tehly a muriva



Sada vrtákov do muriva/ kovu/ muriva **P-23818** **22,99 €** (MOC s DPH)

HSS 3; 4; 5; 6; 8; 10
murivo 3; 4; 5; 6; 8; 10
drevo 3; 4; 5; 6; 8; 10
18 ks v PVC obal



Sada vrtákov HSS – Tin 19 ks **D-67527** **20,29 €** (MOC s DPH)

1,5 x 2; 2 x 2; 2,5 x 2; 3 x 2; 3,2; 3,5
4; 4,5; 5; 5,5; 6; 6,5; 7; 8; 10



Sadad vrtákov HSS-CO 5 % 10 ks **D-57174** **34,19 €** (MOC s DPH)

1; 2; 3; 4; 5; 6; 7; 8; 9; 10;



VŔTANIE: HSS-CO VRTÁKY DO KOVU Z RÝCHLOREZNEJ OCELE S VALCOVITOU STOPKOU

Dĺžka	Priemer mm	Upínanie	Použitie	Počet brítov	Obj. č.	MOC s DPH
-------	------------	----------	----------	--------------	---------	-----------

Záhlbníkový trojbrítový vrták do kovu HSS 90°



DIN 338

Valcovitá stopka. Na hlboké zapustenie sa používa záhlbník s tromi frézami a veľkými drážkami. Je to najbežnejší typ zahĺbenia.



	4,3	valcovitá stopka	M2	3	P-73514	4,49 €
	5,3	valcovitá stopka	M2,5	3	P-73520	4,49 €
	6,3	valcovitá stopka	M3	3	P-73536	5,09 €
	8,3	valcovitá stopka	M4	3	P-73542	5,99 €
	9,4	valcovitá stopka	M4,5	3	P-73558	7,09 €
	10,4	valcovitá stopka	M5	3	P-73564	7,39 €
	12,4	valcovitá stopka	M6	3	P-73570	9,19 €
	16,5	valcovitá stopka	M8	3	P-73586	13,59 €

Záhlbníkový trojbrítový vrták do kovu HSS-CO 90°



DIN 338

Záhlby so šikmými otvormi majú kužeľovú hlavu so šikmým otvorom. Reznú hranu tvorí šikmý otvor na reznej hlave. Vďaka špeciálnej geometrii reznej hrany môže pilina unikať kontinuálnym tokom, čo umožňuje stabilnejšie, hladšie a zaoblené zahĺbenie, najmä u tenkých plechov.



	6,3	valcovitá stopka	M3	3	P-73601	8,49 €
	8,3	valcovitá stopka	M4	3	P-73617	10,89 €
	10,4	valcovitá stopka	M5	3	P-73623	12,89 €
	12,4	valcovitá stopka	M6	3	P-73639	16,39 €
	16,5	valcovitá stopka	M8	3	P-73645	24,59 €

Záhlbníkový vrták do kovu HSS 90°



DIN 338

Záhlbník so šikmými otvormi ma kužeľovú hlavu so šikmým otvorom. Reznú hranu tvorí šikmý otvor na reznej hlave. Vďaka špeciálnej geometrii reznej hrany môže pilina unikať kontinuálnym tokom, čo umožňuje stabilnejšie, hladšie a zaoblené zahĺbenie, najmä u tenkých plechov.



	5 – 10	valcovitá stopka	90°	1	P-73651	9,19 €
	15 – 20	valcovitá stopka	90°	1	P-73667	12,49 €

Sada záhlbníkov 6 ks

P-73592

57,79 € (MOC s DPH)

Dĺžka: 45 mm – 63 mm
 Priemer: 6,3 mm, 8,3 mm, 10,4 mm, 12,4 mm, 16,5 mm, 20,5 mm
 Valcovitá stopka 5 – 10 mm
 3 – brít
 Hlboké zahĺbenie pre otvory: M3, M4, M5, M6, M8, M10

DIN 338



Akumulátory
 Odkladacie systémy
 Vŕtanie
 Skrutkovanie
 Brúsky
 Pílenie
 Frézovanie
 Brúsenie
 Kince / spony
 Špeciálne stroje
 Vysávanie
 Fény/lampy
 Záhraďa
 Ručné náradie
 Ostatné

VRTANIE: STUPŇOVITÉ VRTÁKY

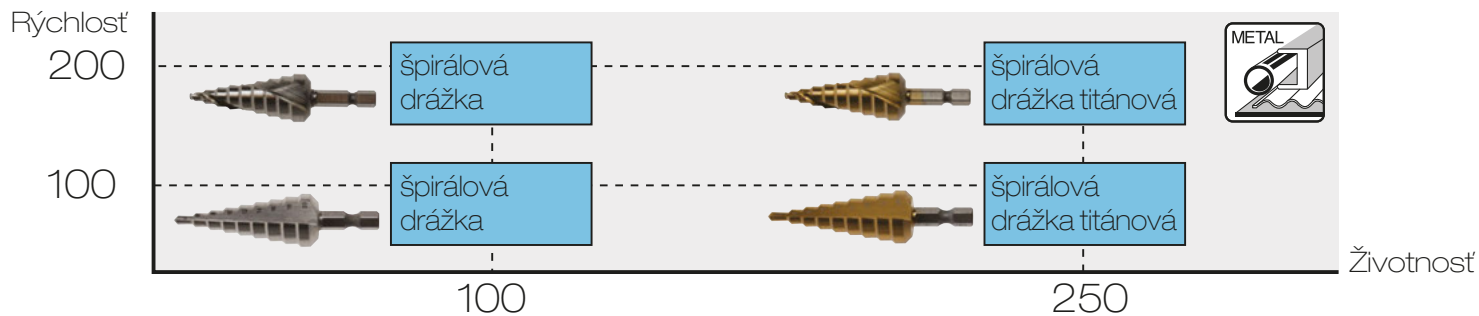

Stupňovité vrtáky HSS-G so špirálovou drážkou



špirálová / 9	valcovitá stopka	4 – 12	P-69892	21,99 €
špirálová / 9	valcovitá stopka	4 – 20	P-69901	37,29 €
špirálová / 14	valcovitá stopka	4 – 30	P-69917	79,49 €
špirálová / 13	valcovitá stopka	6 – 30	P-69923	77,89 €
špirálová / 12	valcovitá stopka	6 – 38	P-69939	100,09 €
špirálová / 12	valcovitá stopka	6 – 37	P-69945	100,09 €

Stupňovité vrtáky HSS-Co + TiN so špirálovou drážkou



špirálová / 9	valcovitá stopka	4 – 12	P-69967	29,59 €
špirálová / 9	valcovitá stopka	4 – 20	P-69973	50,09 €
špirálová / 13	valcovitá stopka	6 – 30	P-69995	110,59 €
špirálová / 12	valcovitá stopka	6 – 38	P-70007	149,69 €

Sada stupňovitých vrtákov 3 ks HSS-G

P-69951 127,79 € (MOC s DPH)

drážka špirálová / 9 pre otvory 4 – 12
 drážka špirálová / 9 4 – 20
 drážka špirálová / 14 4 – 30



Sada stupňovitých vrtákov 3 ks HSS-Co + TiN

P-70029 192,59 € (MOC s DPH)

drážka špirálová / 9 pre otvory 4 – 12
 drážka špirálová / 9 4 – 20
 drážka špirálová / 14 4 – 30



VŔTANIE: SKLO

ø mm	L1 mm	L2 mm	ks/bal	Obj. č.	MOC s DPH
------	-------	-------	--------	---------	-----------

Vrtáky do skla s 1/4" šesťhrannou stopkou



4	65		1	D-15942	3,29 €
5	65		1	D-15958	3,29 €
6	65		1	D-15964	3,69 €
8	70		1	D-15970	3,69 €
10	80		1	D-15986	4,89 €

Vrtáky do skla s valcovou stopkou



3	65		1	P-60012	3,09 €
4	65		1	P-60028	3,19 €
5	65		1	P-60034	3,39 €
6	65		1	P-60040	3,59 €
7	70		1	P-60056	3,89 €
8	70		1	P-60062	4,09 €
9	70		1	P-60078	4,59 €
10	98		1	P-60084	4,89 €
12	98		1	P-60090	5,89 €
13	98		1	P-60109	6,79 €

VŔTANIE: DO MURIVA A KAMEŇA

ø mm	L1 mm	L2 mm	ks/bal	Obj. č.	MOC s DPH
------	-------	-------	--------	---------	-----------

Vrtáky do muriva a kameňa s valcovitou stopkou



4	70	40	1	D-05234	1,19 €
5	85	50	1	D-05240	1,19 €
6	100	60	1	D-05256	1,19 €
6	150	90	1	D-05262	1,19 €
8	110	90	1	D-05290	1,29 €
8	150	90	1	D-05309	1,29 €
10	150	90	1	D-05321	1,69 €
12	150	90	1	D-05343	1,99 €
12	600	550	1	D-17728	5,19 €
13	150	90	1	D-05359	1,99 €
14	150	90	1	D-05365	2,49 €
15	150	90	1	D-05371	3,09 €
16	600	550	1	D-17734	7,09 €

Sada vrtákov do muriva a kameňa

D-72877

5,79 €

(MOC s DPH)

valcovitá stopka
ø mm 4, 5, 6, 8, 10



Ploché frézovacie vrtáky do dreva



D priemer mm
L1 celková dĺžka
L2 pracovná dĺžka
Vhodné pre mäkké aj tvrdé drevo so šesťhrannou stopkou

ø mm	L1 mm	L2 mm	ks/bal	Obj. č.	MOC s DPH
10	150	120	1	D-07696	1,39 €
12	150	120	1	D-07705	1,49 €
14	150	120	1	D-07711	1,89 €
16	150	120	1	D-07733	2,59 €
18	150	120	1	D-07749	2,09 €
20	150	120	1	D-07755	2,29 €
22	150	120	1	D-07761	1,99 €
24	150	120	1	D-07777	1,79 €
25	150	120	1	D-07783	2,59 €
26	160	130	1	D-07799	2,39 €
28	160	130	1	D-07808	2,99 €
30	160	130	1	D-07814	3,49 €
32	160	130	1	D-07820	2,69 €
34	160	130	1	D-07836	2,89 €
35	160	130	1	D-07842	2,99 €
36	160	130	1	D-07858	4,29 €

Ploché frézovacie vrtáky do dreva



D priemer mm
L1 celková dĺžka
L2 pracovná dĺžka
Ideálne pre väčšinu druhov dreva, tvrdé alebo mäkké, šesťhranná stopka

štandardná dĺžka					
ø mm	L1 mm	L2 mm	ks/bal	Obj. č.	MOC s DPH
6	150	120	1	P-58643	1,29 €
8	150	120	1	P-58659	1,49 €
10	150	120	1	P-58665	1,59 €
12	150	120	1	P-58671	1,59 €
14	150	120	1	P-58687	1,59 €
15	150	120	1	P-58693	1,69 €
16	150	120	1	P-58702	1,79 €
18	150	120	1	P-58713	1,89 €
20	150	120	1	P-58724	1,99 €
22	150	120	1	P-58730	2,09 €
24	150	120	1	P-58746	2,19 €
25	150	120	1	P-58752	2,49 €
26	160	130	1	P-58768	2,69 €
28	160	130	1	P-58774	2,89 €
30	160	130	1	P-58780	2,99 €
32	160	130	1	P-58796	3,39 €
34	160	130	1	P-58805	3,69 €
35	160	130	1	P-58811	3,79 €
36	160	130	1	P-58827	3,89 €

Predĺženie	D-77213	cena na vyžiadanie (MOC s DPH)
predĺženie pre vrtáky so šesťhranným upnutím celková dĺžka 300 mm upínanie 1/4"		

Sada vrtákov	E-08698	25,19 € (MOC s DPH)
12, 14, 16, 18, 20, 22, 25, 32 x 150 mm		

VŔTANIE: DREVO

ø mm	L1 mm	L2 mm	ks/bal	Obj. č.	MOC s DPH
------	-------	-------	--------	---------	-----------

Vrták špirálový do dreva s dvomi ostriami a centrovacím hrotom; valcovitá stopka

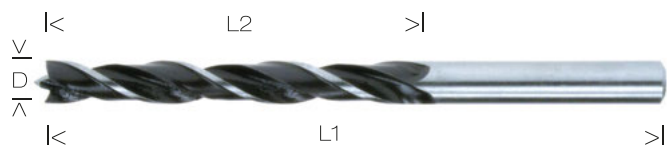

D priemer mm
L1 celková dĺžka
L2 pracovná dĺžka



štandardná dĺžka					
3	60	30	1	D-07026	0,79 €
4	75	43	1	D-07032	0,79 €
5	85	50	1	D-07048	0,69 €
6	95	58	1	D-07054	0,79 €
8	115	73	1	D-07076	1,19 €
9	125	80	1	D-07082	1,29 €
12	155	100	1	D-07107	2,19 €
13	151	96	1	D-53453	cena na vyžiadanie
14	170	120	1	D-07113	2,79 €
15	160	100	1	D-53469	cena na vyžiadanie
16	180	130	1	D-07129	3,59 €
18	200	140	1	D-07135	5,79 €
20	200	140	1	D-07141	5,99 €
predĺžené					
6	315	150	1	D-07157	3,59 €
8	315	150	1	D-07163	3,89 €
10	315	150	1	D-07179	3,79 €
12	315	150	1	D-07185	4,79 €
14	315	150	1	D-07191	6,99 €
16	315	150	1	D-07200	9,09 €
18	335	150	1	D-07216	9,39 €
20	335	150	1	D-07222	11,19 €

Skrutkovicové vrtáky do dreva s 1/4" upínaním



1/4" Šesthranné stopkové upínanie
Vhodné na vrtanie otvorov s malým alebo stredným priemerom.
Schopný vrtáť aj mäkké plasty.



6	315		1	P-57679	2,49 €
8	315		1	P-57685	2,99 €
10	315		1	P-57691	3,79 €
12	315		1	P-57700	4,89 €
14	315		1	P-57716	5,89 €
16	315		1	P-57722	7,49 €
8	450		1	P-57750	5,09 €
16	450		1	P-57794	11,29 €
18	450		1	P-57803	14,39 €
20	450		1	P-57819	17,99 €

Špirálové vrtáky do dreva podľa DIN338



3	60		1	P-57473	0,49 €
4	75		1	P-57489	0,59 €
5	85		1	P-57495	0,59 €
6	95		1	P-57504	0,69 €
7	110		1	P-57510	0,79 €
8	115		1	P-57526	0,89 €
9	125		1	P-57532	1,09 €
10	135		1	P-57548	1,19 €
12	155		1	P-57554	1,79 €
14	170		1	P-57560	2,59 €
16	180		1	P-57576	3,49 €
18	200		1	P-57582	5,59 €
20	200		1	P-57598	6,49 €
22	205		1	P-57607	9,19 €
24	215		1	P-57613	11,29 €
26	215		1	P-57629	13,69 €
28	220		1	P-57635	16,69 €
30	220		1	P-57641	19,39 €

Špirálové vrtáky do dreva s valcovitou stopkou



8	600		1	P-57940	10,49 €
10	600		1	P-57956	11,29 €
12	600		1	P-57962	13,89 €
16	600		1	P-57984	18,69 €
30	600		1	P-58051	49,69 €

ø mm	L1 mm	L2 mm	ks/bal	Obj. č.	MOC s DPH
------	-------	-------	--------	---------	-----------

Vrtáky do dreva so šesťhrannou stopkou

4	200		1	P-58067	4,39 €
5	200		1	P-58073	4,39 €
6	200		1	P-58089	5,19 €
8	200		1	P-58095	5,69 €
8	300		1	P-58213	7,99 €
8	450		1	P-58350	10,39 €
8	600		1	P-58497	11,69 €
10	200		1	P-58104	6,69 €
10	300		1	P-58229	8,59 €
10	450		1	P-58366	10,59 €
10	600		1	P-58506	12,39 €
12	200		1	P-58110	7,89 €
12	300		1	P-58235	10,09 €
12	450		1	P-58372	12,69 €
12	600		1	P-58512	14,59 €
14	450		1	P-58388	15,49 €
14	600		1	P-58528	17,79 €
15	300		1	P-58257	14,09 €
16	200		1	P-58132	9,69 €
16	300		1	P-58263	14,49 €
16	450		1	P-58403	17,69 €
16	600		1	P-58534	20,09 €
18	200		1	P-58148	10,99 €
18	300		1	P-58279	16,99 €
18	450		1	P-58419	20,49 €
18	600		1	P-58540	24,69 €
20	200		1	P-58154	12,59 €
20	300		1	P-58285	18,79 €
20	450		1	P-58425	22,59 €
20	600		1	P-58556	27,39 €
22	200		1	P-58160	13,29 €
22	300		1	P-58291	20,49 €
22	450		1	P-58431	26,49 €
22	600		1	P-58562	29,79 €
24	200		1	P-58176	14,99 €
24	300		1	P-58300	22,29 €
24	450		1	P-58447	28,59 €
24	600		1	P-58578	33,29 €
25	300		1	P-58316	24,69 €
25	450		1	P-58453	32,89 €
26	300		1	P-58322	26,49 €
26	600		1	P-58584	40,89 €
28	300		1	P-58338	29,89 €
30	200		1	P-58207	21,79 €
30	300		1	P-58344	32,99 €
30	450		1	P-58481	44,49 €
30	600		1	P-58609	51,39 €
32	600		1	P-58615	55,39 €
34	600		1	P-58621	68,89 €
36	600		1	P-58637	75,49 €

Sady vrtákov do dreva

Sada vrtákov do dreva 7 ks

D-62371

8,29 € (MOC s DPH)

1/4" upínanie, 7 ks,
ø mm 2, 3, 3, 4, 5, 6, 8



Vrták do dreva 1/4" upínanie

D-15992

3,99 € (MOC s DPH)

ø 6 × 200 mm



Sada vrtákov do dreva 5 ks

P-57657

3,89 € (MOC s DPH)

valcovitá stopka
ø mm 4, 5, 6, 8, 10



Vrták do dreva 1/4" upínanie

D-16003

3,79 € (MOC s DPH)

ø 8 × 200 mm



Sada vrtákov do dreva 5 ks

D-72861

6,09 € (MOC s DPH)

valcovitá stopka
ø mm 4, 5, 6, 8, 10



Sada vrtákov do dreva 7 ks

P-57663

5,99 € (MOC s DPH)

valcovitá stopka
ø mm 3, 4, 5, 6, 7, 8, 10



ø mm

L1 mm

L2 mm

ks/bal

Obj. č.

MOC s DPH

Vrtáky na pánty



Forstnerové vrtáky s vystredovacou špičkou s 2 ostriami



8	90		1	P-58833	3,99 €
10	90		1	P-58849	4,19 €
12	90		1	P-58855	4,59 €
14	90		1	P-58861	5,09 €
15	90		1	P-58877	5,49 €
16	90		1	P-58883	5,69 €
18	90		1	P-58899	6,09 €
20	90		1	P-58908	6,29 €
22	90		1	P-58914	6,49 €
24	90		1	P-58920	6,89 €
25	90		1	P-58936	7,19 €
26	90		1	P-58942	7,89 €
28	90		1	P-58958	8,49 €
30	90		1	P-58964	8,79 €
32	90		1	P-58970	9,39 €
34	90		1	P-58986	9,99 €
35	90		1	P-58992	10,39 €
36	90		1	P-59003	10,69 €
38	90		1	P-59019	10,99 €
40	90		1	P-59025	12,29 €
42	90		1	P-59031	15,39 €
45	90		1	P-59047	15,39 €
48	90		1	P-58053	18,89 €
50	90		1	P-58069	18,89 €

Vrtáky na pánty so šesťhrannou stopkou



32	127		1	D-29963	15,29 €
57	127		1	D-30025	31,49 €
65	127		1	D-30031	33,89 €
92	127		1	D-56518	64,59 €

ø mm	L1 mm	L2 mm	ks/bal	Obj. č.	MOC s DPH
------	-------	-------	--------	---------	-----------

Skrutkové vrtáky do dreva s valcovitou stopkou

6	200	130	1	D-07238	3,29 €
8	200	130	1	D-07244	3,39 €
10	200	130	1	D-07250	4,29 €
12	200	130	1	D-07266	3,69 €
14	200	130	1	D-07272	4,29 €
16	200	130	1	D-07288	4,79 €
18	200	130	1	D-07294	4,79 €
20	200	130	1	D-07303	5,79 €
22	200	130	1	D-07319	7,59 €
24	200	130	1	D-07325	8,79 €
6	250	180	1	D-07331	3,39 €
8	250	180	1	D-07347	3,69 €
10	250	180	1	D-07353	4,39 €
12	250	180	1	D-07369	4,79 €
14	250	180	1	D-07375	5,59 €
16	250	180	1	D-07381	5,79 €
18	250	180	1	D-07397	6,79 €
20	250	180	1	D-07406	7,39 €
22	250	180	1	D-07412	8,69 €
24	250	180	1	D-07428	9,89 €
8	400	230	1	D-07434	6,59 €
10	400	230	1	D-07440	6,19 €
12	400	230	1	D-07456	8,29 €
14	400	230	1	D-07462	8,19 €
16	400	230	1	D-07478	10,29 €
18	400	230	1	D-07484	11,89 €
20	400	230	1	D-07490	12,59 €
22	400	230	1	D-07509	13,89 €
24	400	230	1	D-07515	15,29 €
26	400	230	1	D-07521	22,29 €
28	400	230	1	D-07537	20,99 €
30	400	230	1	D-07543	25,69 €
8	450	370	1	D-07559	7,89 €
10	450	370	1	D-07565	7,89 €
12	450	370	1	D-07571	10,59 €
14	450	370	1	D-07587	9,99 €
16	450	370	1	D-07593	12,99 €
18	450	370	1	D-07602	13,19 €
20	450	370	1	D-07618	18,09 €
22	450	370	1	D-07624	16,29 €
24	450	370	1	D-07630	21,19 €
26	450	370	1	D-07646	21,99 €
28	450	370	1	D-07652	25,69 €
30	450	370	1	D-07668	41,89 €

VŔTANIE: DREVO

ø mm	L1 mm	L2 mm	ks/bal	Obj. č.	MOC s DPH
------	-------	-------	--------	---------	-----------

Špirálový vrták do dreva s valcovitou stopkou



8	600		1	P-57940	10,49 €
10	600		1	P-57956	11,29 €
12	600		1	P-57962	13,89 €
16	600		1	P-57984	18,69 €
30	600		1	P-58051	49,69 €

3D skrutkovité vrtáky do dreva s valcovitou stopkou

























8	400	325	1	E-07761	29,69 €
18	500	425	1	E-07967	47,89 €
22	400	325	1	E-07886	63,69 €

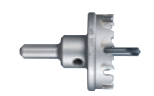

Akumulátory
Odkladacie systémy
Vrtanie
Skrutkovanie
Brúsky
Pílenie
Frézovanie
Brúsenie
Klince / spony
Špeciálne stroje
Vysávanie
Fény/lampy
Záhrada
Ručné náradie
Ostatné

Tabuľka použitia

AA : Odporúčené A : Akceptovateľné

Použitie		železo	nerez	Aluminum	neželezné kovy	drevo	MDF	sádrokartón	PVC	sklo-laminát	mäkké obklady	tehla	vápenec	mramor
														
BiM	<i>Ezychange</i> Bi-Metal HSS 8%Co 	AA	A	AA	AA	AA			AA					
	BiM 	AA		A	A	AA			AA					
	BiM pre plechy 	AA	AA	A	A									
Karbíd volfrámu	<i>Ezychange</i> TCT 	AA	AA	AA	AA	AA			AA		A	A	A	
	Viacúčelový TCT 					AA	AA	AA	AA	AA	A		A	
	TCT 	AA	AA	A	A				AA	AA				
	TC zrnitý 										AA	AA		
Diamantové	Vákuovo spájkovaný diamant 										AA	AA	AA	AA
	Diamond wet holesaw 										AA			AA
Uhlíková oceľ	Uhlíková oceľ 					A		A	A					

VŔTANIE: VYKRUŽOVACIE KORUNKY

ø mm	L1	Adaptér	ks/bal	Obj. č.	MOC s DPH
------	----	---------	--------	---------	-----------

BiM vykružovacie korunky



BiM vykružovacie korunky
HSS bimetal

Na vrtanie do ocele, farebných kovov, plastov, dreva a sadrokartónu.

16	38	D-17170 / D-17603	1	D-16994	3,59 €
19	38	D-17170 / D-17603	1	D-17005	4,59 €
20	38	D-17170 / D-17603	1	D-17251	4,49 €
22	38	D-17170 / D-17603	1	D-17011	5,09 €
24	38	D-17170 / D-17603	1	D-17027	4,89 €
25	38	D-17170 / D-17603	1	D-17033	5,19 €
29	38	D-17170 / D-17603	1	D-17267	6,49 €
32	38	D-17186 / D-17619	1	D-17049	6,69 €
35	38	D-17186 / D-17619	1	D-17055	6,99 €
38	38	D-17186 / D-17619	1	D-17061	8,19 €
40	38	D-17186 / D-17619	1	D-17273	8,49 €
44	38	D-17186 / D-17619	1	D-17077	8,39 €
51	38	D-17186 / D-17619	1	D-17083	9,39 €
54	38	D-17186 / D-17619	1	D-24876	9,79 €
57	38	D-17186 / D-17619	1	D-17099	10,19 €
60	38	D-17186 / D-17619	1	D-25688	10,69 €
65	38	D-17186 / D-17619	1	D-24882	11,39 €
68	38	D-17186 / D-17619	1	D-17108	11,99 €
70	38	D-17186 / D-17619	1	D-25694	12,99 €
76	38	D-17186 / D-17619	1	D-17114	14,09 €
80	38	D-17186	1	D-33869	14,49 €
83	38	D-17186	1	D-17120	14,29 €
92	38	D-17186	1	D-17136	17,09 €
105	38	D-17186	1	D-17142	18,19 €
127	38	D-17186	1	D-17158	22,89 €
152	38	D-17186	1	D-17164	26,59 €

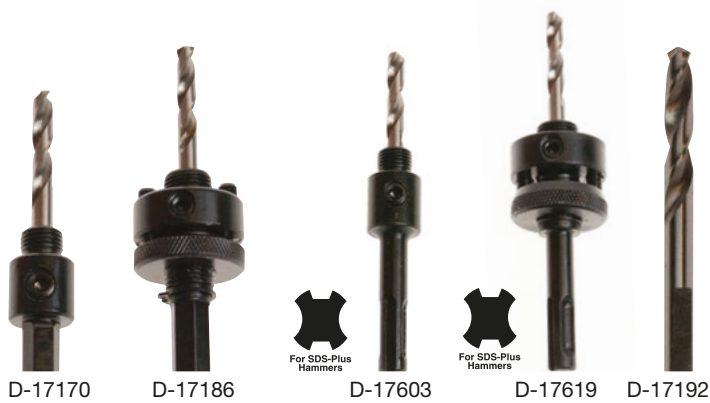

ø mm	ø mm	Adaptér/ upínanie	ks/bal	Obj. č.	MOC s DPH
16 - 29		Hex	1	D-17170	5,19 €
30 - 152		Hex	1	D-17186	9,79 €
14 - 29		SDS-PLUS	1	D-17603	6,69 €
30 - 76		SDS-PLUS	1	D-17619	11,69 €
6	75	centrovací vrták	1	D-17192	3,59 €

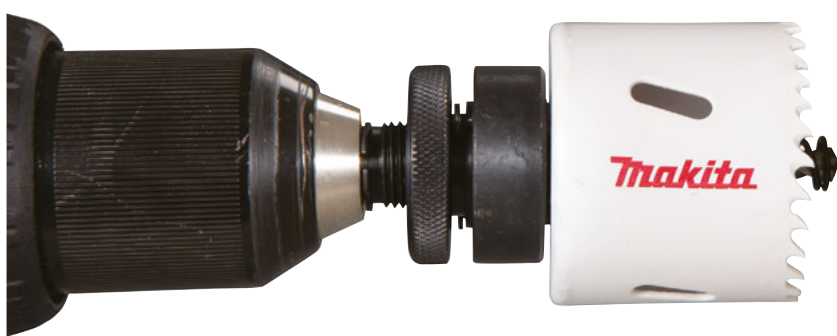

Akumulátory
Odkladacie systémy
Vŕtanie
Skrutkovanie
Brúsky
Pílenie
Frézovanie
Brúsenie
Klince / spony
Špeciálne stroje
Vysávanie
Fény/lampy
Záhradka
Ručné náradie
Ostatné

VŔTANIE: VYKRUŽOVACIE KORUNKY

Vykružovacie korunky sady

Sada vykružovacích korúnok vodárenská **D-47117** **57,69 €** (MOC s DPH)

ø 19, 22, 29, 38, 44, 57mm
2x adaptér



Sada vykružovacích korúnok vodárenská **D-63965** **62,99 €** (MOC s DPH)

ø 19, 22, 29, 38, 44, 57mm
2x adaptér



Sada vykružovacích korúnok elektrikárska **D-47139** **64,19 €** (MOC s DPH)

ø 20, 25, 32, 40, 51, 65mm
2x adaptér



Sada vykružovacích korúnok elektrikárska **D-47123** **56,19 €** (MOC s DPH)

ø 16, 20, 25, 32, 40, 51mm
2x adaptér



Sada Bi – metalových vykružovacích korúnok **D-33641** **23,89 €** (MOC s DPH)

ø 22, 25, 29, 32 mm
adaptér



Sada Bi – metalových vykružovacích korúnok **D-33657** **26,59 €** (MOC s DPH)

ø 22, 29, 32, 51 mm
adaptér



EzyChange sada vykružovacích korúnok **E-12304** **148,29 €** (MOC s DPH)

vodárenská
ø 19, 22, 29, 38, 44, 57 mm,
adaptér, strediaci vrták



EzyChange sada vykružovacích korúnok **E-12310** **137,09 €** (MOC s DPH)

elektrikárska
ø 16, 20, 25, 32, 40, 51 mm,
adaptér, strediaci vrták



EzyChange sada vykružovacích korúnok **E-12326** **154,09 €** (MOC s DPH)

elektrikárska
ø 20, 25, 32, 40, 65 mm,
adaptér, strediaci vrták



VŔTANIE: VYKRUŽOVACIE KORUNKY

ø mm	L1	Adaptér	ks/bal	Obj. č.	MOC s DPH
------	----	---------	--------	---------	-----------

Bimetalové korunky kov + 5% kobalt



HSS Bi-Metal zub s premenlivým rozstupom 4-btpi s 5% obsahom kobaltu pre dlhšiu životnosť.

Vhodné na drevo, sadrokartón, plasty, neželezné kovy, hliník, oceľ a nehrdzavejúcu oceľ.

Priemery od 14 – 152 mm s šesťhrannými a SDS adaptérmi a navyše adaptéry so šesťhranným a SDS-Plus upínaním dlhý strediaci vrták.

14	38	P-35156 / P-35178	1	P-52451	7,79 €
16	38	P-35156 / P-35178	1	P-34936	8,49 €
17	38	P-35156 / P-35178	1	P-52467	8,49 €
19	38	P-35156 / P-35178	1	P-34942	8,49 €
20	38	P-35156 / P-35178	1	P-52473	8,49 €
21	38	P-35156 / P-35178	1	P-52489	8,79 €
22	38	P-35156 / P-35178	1	P-34958	9,09 €
24	38	P-35156 / P-35178	1	P-34964	9,69 €
25	38	P-35156 / P-35178	1	P-34970	9,69 €
27	38	P-35156 / P-35178	1	P-52495	9,69 €
29	38	P-35156 / P-35178	1	P-52504	9,69 €
30	38	P-35162 / P-35184	1	P-52510	9,69 €
32	38	P-35162 / P-35184	1	P-34986	10,69 €
33	38	P-35162 / P-35184	1	P-52526	10,69 €
35	38	P-35162 / P-35184	1	P-34992	11,29 €
37	38	P-35162 / P-35184	1	P-52532	11,29 €
38	38	P-35162 / P-35184	1	P-35003	11,49 €
40	38	P-35162 / P-35184	1	P-52548	11,49 €
41	38	P-35162 / P-35184	1	P-52554	11,69 €
43	38	P-35162 / P-35184	1	P-52560	11,89 €
44	38	P-35162 / P-35184	1	P-35019	12,39 €
46	38	P-35162 / P-35184	1	P-52576	12,39 €
48	38	P-35162 / P-35184	1	P-52582	12,39 €
51	38	P-35162 / P-35184	1	P-35025	13,59 €
52	38	P-35162 / P-35184	1	P-52598	13,59 €
54	38	P-35162 / P-35184	1	P-52607	14,59 €
57	38	P-35162 / P-35184	1	P-35031	14,99 €
59	38	P-35162 / P-35184	1	P-52613	15,59 €
60	38	P-35162 / P-35184	1	P-52629	15,59 €
64	38	P-35162 / P-35184	1	P-52635	15,59 €
65	38	P-35162 / P-35184	1	P-52641	15,79 €
67	38	P-35162 / P-35184	1	P-52657	16,39 €
68	38	P-35162 / P-35184	1	P-35047	16,69 €
70	38	P-35162 / P-35184	1	P-52663	17,39 €
73	38	P-35162 / P-35184	1	P-52679	17,39 €
76	38	P-35162 / P-35184	1	P-35053	17,99 €
79	38	P-35162 / P-35184	1	P-52685	18,59 €
83	38	P-35162 / P-35184	1	P-35069	19,59 €
86	38	P-35162 / P-35184	1	P-52691	19,99 €
89	38	P-35162 / P-35184	1	P-52700	20,59 €
92	38	P-35162 / P-35184	1	P-35075	21,39 €
95	38	P-35162 / P-35184	1	P-52716	21,99 €
98	38	P-35162 / P-35184	1	P-52722	23,19 €
102	38	P-35162 / P-35184	1	P-52738	23,49 €
105	38	P-35162 / P-35184	1	P-35081	25,99 €
108	38	P-35162 / P-35184	1	P-52744	27,19 €
111	38	P-35162 / P-35184	1	P-52750	27,79 €
114	38	P-35162 / P-35184	1	P-52766	28,79 €
121	38	P-35162 / P-35184	1	P-52772	30,59 €
127	38	P-35162 / P-35184	1	P-35097	34,29 €
140	38	P-35162 / P-35184	1	P-52788	41,79 €
146	38	P-35162 / P-35184	1	P-52794	45,59 €
152	38	P-35162 / P-35184	1	P-35106	50,29 €

P-35156

P-35162



P-35190



P-35178

ø mm	ø mm	Adaptér/ upínanie	ks/bal	Obj. č.	MOC s DPH
14 – 30	9,5	šesťhran	1	P-35156	12,39 €
32 – 210	11	šesťhran	1	P-35162	22,89 €
32 – 210	11	šesťhran	1	P-35190	21,39 €
14 – 30		SDS-Plus	1	P-35178	20,79 €
32 – 210		SDS-Plus	1	P-35184	28,79 €
	83	centrovací vrták	1	P-35209	6,49 €
	102	centrovací vrták	1	P-35215	6,79 €

Max rýchlosť vrtania

ø mm	oceľ	meď	hliník	inox	drevo
16	530	730	825	275	3000
19	460	600	690	230	3000
20	440	580	675	220	3000
22	390	520	585	195	3000
24	370	490	555	185	2700
25	350	470	525	175	2700
29	300	400	450	150	2700
30	285	380	425	145	2400
32	275	360	410	140	2400
35	250	330	375	125	2400
38	230	300	345	115	2400
41	210	280	315	105	2100
44	195	260	295	95	2100
48	180	240	270	90	2100

ø mm	oceľ	meď	hliník	inox	drevo
57	170	230	255	85	2000
57	150	200	225	75	2000
60	140	190	220	70	2000
64	135	180	205	65	1850
68	130	170	190	65	1800
70	125	160	185	60	1800
76	115	150	170	55	1800
83	105	140	155	50	1500
92	90	120	140	45	1200
102	85	110	130	40	1000
105	85	110	130	40	1000
127	80	110	120	40	1000
152	65	90	90	30	800

ø mm	L1	Adaptér	ks/bal	Obj. č.	MOC s DPH
------	----	---------	--------	---------	-----------

Vykružovacie korunky EZYCHANGE Bi-Metal 8%Co



Ezychange



HSS Bi-Metal Ezychange vykružovacie korunky
Potrebný je iba jeden adaptér pre veľkosti 16 – 152 mm s rýchlopínacím strediacim vrtákom.
Vyrobený z HSS Bi-Metal s 8% kobaltu a progresívnou geometriou zubov zaručuje dlhú životnosť a vysokú rýchlosť rezania. Vhodné pre železné a neželezné kovy, nehrdzavejúcu oceľ, hliník, drevo a plasty.

Korunky Ezychange je možné zakúpiť jednotlivo, alebo ako súpravu navrhnutú v tých správnych veľkostiach, ktoré vyhovujú vášmu remeslu. Kompatibilné s inými významnými výrobcami rýchlo vymeniteľných korúnok.

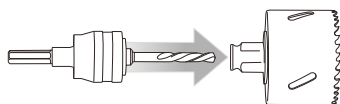
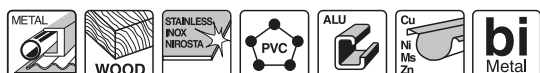

ø mm	ø mm	Adaptér/ upňanie	ks/bal	Obj. č.	MOC s DPH
		EzyChange adaptér centrovací vrtáka HSS-G	1	E-04070	31,59 €
6,35	85	centrovací vrtáka HSS-G	1	E-04086	9,19 €
6,35	85	centrovací vrtáka HSS-CO	1	E-04092	10,89 €

16	44	E-04070	1	E-03632	9,89 €
17	44	E-04070	1	E-03648	10,49 €
19	44	E-04070	1	E-03654	10,29 €
20	44	E-04070	1	E-03660	10,79 €
22	44	E-04070	1	E-03676	11,29 €
24	44	E-04070	1	E-03682	10,79 €
25	44	E-04070	1	E-03698	11,49 €
27	44	E-04070	1	E-03707	11,09 €
29	44	E-04070	1	E-03713	21,99 €
30	44	E-04070	1	E-03729	12,49 €
32	44	E-04070	1	E-03735	12,69 €
35	44	E-04070	1	E-03741	13,89 €
37	44	E-04070	1	E-03757	12,49 €
38	44	E-04070	1	E-03763	13,29 €
40	44	E-04070	1	E-03779	13,49 €
41	44	E-04070	1	E-03785	15,09 €
44	44	E-04070	1	E-03791	14,79 €
46	44	E-04070	1	E-03800	13,89 €
48	44	E-04070	1	E-03816	17,09 €
51	44	E-04070	1	E-03822	16,09 €
52	44	E-04070	1	E-03838	16,79 €
54	44	E-04070	1	E-03844	17,29 €
56	44	E-04070	1	E-03850	16,29 €
57	44	E-04070	1	E-03866	19,09 €
60	44	E-04070	1	E-03872	20,19 €
64	44	E-04070	1	E-03888	19,69 €
65	44	E-04070	1	E-03894	21,29 €
68	44	E-04070	1	E-03903	22,59 €
70	44	E-04070	1	E-03919	20,39 €
73	44	E-04070	1	E-03925	22,49 €
76	44	E-04070	1	E-03931	22,99 €
79	44	E-04070	1	E-03947	21,49 €
83	44	E-04070	1	E-03953	21,79 €
86	44	E-04070	1	E-03969	20,89 €
92	44	E-04070	1	E-03975	25,09 €
95	44	E-04070	1	E-03981	26,29 €
102	44	E-04070	1	E-03997	34,89 €
105	44	E-04070	1	E-04008	31,79 €
111	44	E-04070	1	E-04014	38,59 €
114	44	E-04070	1	E-04020	39,79 €
121	44	E-04070	1	E-04036	46,29 €
127	44	E-04070	1	E-04042	58,19 €
133	44	E-04070	1	E-14174	55,59 €
140	44	E-04070	1	E-04058	49,59 €
152	44	E-04070	1	E-04064	56,29 €



Ezychange Bi-Metal HSS 8%Co

VŔTANIE: VYKRUŽOVACIE KORUNKY

Ľahké vykružovacie korunky UNICUT



ø mm	L1 mm	L2 mm	ks/bal	Obj. č.	MOC s DPH
------	-------	-------	--------	---------	-----------



35	75		1	P-64484	36,69 €
40	75		1	P-64490	38,69 €
50	75		1	P-64515	41,89 €
55	75		1	P-64521	44,99 €
60	75		1	P-64543	47,79 €
68	75		1	P-64571	52,39 €
70	75		1	P-64587	60,19 €
71	75		1	P-64593	61,29 €
74	75		1	P-64602	62,09 €
76	75		1	P-64618	64,09 €
80	75		1	P-64630	65,99 €
85	75		1	P-64646	71,79 €
105	75		1	P-64668	95,39 €

Ľahká konštrukcia týchto vŕtacích korúnok výrazne rozširuje spektrum využitia vŕtacích kladív SDS-PLUS ľahkých stavebných hmôt. Hlavnou oblasťou ich využitia sú rôzne remeselnícke práce a práce v dome pri inštaláciách do muriva a moderných ľahkých stavebných hmôt.

Príslušenstvo k vykružovacím korunkám UNICU, závit M16

strediaci vŕták 8 ø	P-64347	5,29 €
adaptér SDS-Plus pre vŕtáciu korunku 118 mm	P-64319	32,09 €
adaptér SDS-Plus pre vŕtáciu korunku 220 mm	P-64325	35,49 €
adaptér SDS-Plus pre vŕtáciu korunku 370 mm	P-64331	40,19 €

Sada korúnok 10 ks

D-51281

116,29 € (MOC s DPH)

22, 25, 29, 35, 38, 45, 51mm
strediaci vŕták 10x100mm
TCT strediaci vŕták 8x100mm
13mm Hex adaptér



Sada korúnok 9 ks

D-51297

168,09 € (MOC s DPH)

22, 35, 51, 57, 64, 76mm
strediaci vŕták 10x100mm
TCT strediaci vŕták 8x100mm
13mm Hex adaptér



Diamantové vŕtáky na kachličky



Na kachličky a dlažbu pre uhlové brúsky pre uhlové brúsky, na sucho, uchytenie M14, max. otáčky 12 000 min⁻¹

ø mm	Obj. č.	MOC s DPH
------	---------	-----------

M14 x 25 mm	D-35025	25,89 €
M14 x 30 mm	D-35019	27,59 €
M14 x 35 mm	D-35003	29,79 €
M14 x 40 mm	D-37007	37,39 €
M14 x 45 mm	D-37013	41,19 €



Diamantové vŕtáky na kachličky, mramor, granit

Pre uhlové brúsky, na sucho, uchytenie M14, max. otáčky 12 000 min⁻¹



L1



5	D-61064	18,19 €
6	D-61070	19,39 €
8	D-61086	19,79 €
10	D-61092	21,19 €
12	D-61101	23,89 €
14	D-44432	37,29 €
16	D-44448	39,29 €
20	D-44454	30,19 €
22	D-44460	27,09 €
25	D-44476	30,49 €
27	D-44482	30,99 €
30	D-44498	39,99 €
32	D-44507	47,09 €
35	D-44513	51,29 €
38	D-44529	49,59 €
40	D-44535	59,69 €
45	D-44541	62,29 €
51	D-44557	73,49 €
60	D-44585	78,29 €
67	D-44600	83,59 €
68	D-44616	99,89 €
70	D-44622	92,79 €
75	D-44638	90,29 €
80	D-44644	101,59 €
83	D-44650	93,69 €

VŔTANIE: VYKRUŽOVACIE KORUNKY

Vykružovacie korunky

Diamantové korunky do tehly, pórobetónu, kachličiek a mramoru



ø mm	L1 mm	odporúčaná otáčky	ks/bal	Obj. č.	MOC s DPH
16	40	3 000 – 5 000 min	1	B-45995	20,79 €
19	40	3 000 – 5 000 min	1	B-46006	24,79 €
25	40	3 000 – 5 000 min	1	B-46012	31,99 €
30	40	3 000 – 5 000 min	1	B-46028	40,39 €
32	40	3 000 – 5 000 min	1	B-46034	41,49 €
35	40	3 000 – 5 000 min	1	B-46040	37,69 €
38	40	3 000 – 5 000 min	1	B-46056	48,39 €
45	40	3 000 – 5 000 min	1	B-46062	57,09 €
50	40	3 000 – 5 000 min	1	B-46078	64,39 €
53	40	3 000 – 5 000 min	1	B-46084	66,89 €
57	40	3 000 – 5 000 min	1	B-46090	78,99 €
64	40	3 000 – 5 000 min	1	B-46109	80,99 €
68	40	3 000 – 5 000 min	1	B-53914	96,99 €

Pre uchytenie s valovitou stopkou

Rovná stopka a stredový vrták 182 / 59 mm M12 – M6	1	B-46115	12,89 €
Rovná stopka 182 mm M12 – M6	1	B-46137	9,39 €
Strediaci vrták 59 mm M6	1	B-46121	4,79 €

Pre uchytenie SDS-Plus

Rovná stopka a stredový vrták 182 / 59 mm M12 – M6	1	B-52691	19,39 €
Rovná stopka 182 mm M12 – M6	1	B-52700	15,29 €

Diamantové vrtáky na kachličky



ø mm	L1 mm	ks/bal	Obj. č.	MOC s DPH
5	30	1	P-66569	9,79 €
6	30	1	P-66575	10,39 €
7	30	1	P-66581	14,69 €
8	30	1	P-66597	11,59 €
10	30	1	P-66612	13,29 €
12	30	1	P-66709	14,19 €
15	30	1	P-66715	16,29 €
20	30	1	P-66721	20,29 €

Diamantové vrtáky na kachličky



19		1	P-70035	22,29 €
22		1	P-70041	25,39 €
29		1	P-70057	31,19 €
35		1	P-70063	51,09 €
38		1	P-70079	33,99 €
44		1	P-70085	37,49 €
64		1	P-70100	45,69 €

Upínací adaptér pre diamantový vrták				
	9,6 pre ø 19 – 29	1	P-35156	12,39 €
	11 pre ø 35 – 64	1	P-35162	22,89 €

Sada diamantových vrtákov 3 ks

P-66628

36,49 € (MOC s DPH)

ø 6, 8, 10 mm
vodou chladené



Sada diamantových vrtákov 3 ks

P-66983

60,89 € (MOC s DPH)

ø 15, 20, 25 mm
vodou chladené



VŔTANIE: VRTÁKY

ø mm	L1 mm	ks/bal	Obj. č.	MOC s DPH
------	-------	--------	---------	-----------

Prílepové vrtáky s valcovitou stopkou



Vrtáky s valcovou stopkou sú určené pre vrtanie do betónu, muríva, a prírodného kameňa. Špeciálna špirála v tvare U zaručuje efektívny odvod odvrátených častíc a dlhú životnosť vrtáku.

3	60	1	P-59592	0,89 €
4	75	1	P-59601	0,99 €
5	85	1	P-59617	1,09 €
6	100	1	P-59623	1,29 €
6	200	1	P-59754	2,49 €
6	400	1	P-59798	3,79 €
7	100	1	P-59639	1,49 €
8	120	1	P-59645	1,59 €
8	200	1	P-59760	3,09 €
8	400	1	P-59807	4,59 €
8	600	1	P-59900	7,99 €
9	120	1	P-59651	1,79 €
10	120	1	P-59667	2,09 €
10	200	1	P-59776	3,39 €
10	400	1	P-59813	5,19 €
10	600	1	P-59916	8,89 €
12	150	1	P-59689	3,09 €
12	200	1	P-59782	4,39 €
12	400	1	P-59829	6,39 €
12	600	1	P-59922	10,49 €
13	150	1	P-59695	3,89 €
14	150	1	P-59704	4,09 €
14	400	1	P-59835	8,09 €
16	400	1	P-59841	9,69 €

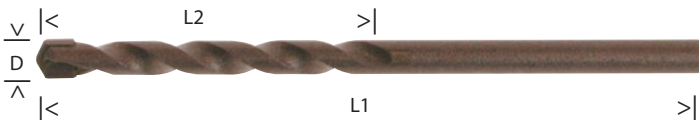

Sada vrtákov do kameňa s valcovitou stopkou D-72877 5,79 € (MOC s DPH)

- 4x70mm
- 5x70mm
- 6x70mm
- 8x110mm
- 10x110mm



Univerzálne vrtáky s valcovitou stopkou



Univerzálne vrtáky s valcovou stopkou určené na vrtanie do betónu, kachličiek, tehly, keramiky, dreva, plastu, hliníku a železa.

3	60	1	D-30287	0,89 €
4	70	1	D-30293	0,89 €
5	85	1	D-30302	1,09 €
6	100	1	D-30318	0,89 €
6	150	1	D-30324	0,89 €
6,5	100	1	D-31061	0,79 €
6,5	150	1	D-31077	0,89 €
7	150	1	D-30346	0,99 €
8	110	1	D-30352	0,99 €
8	150	1	D-30368	1,59 €
10	150	1	D-30380	1,49 €
10	400	1	D-30396	4,19 €
12	150	1	D-30411	1,79 €
12	600	1	D-30433	7,29 €
13	150	1	D-30449	1,99 €
14	150	1	D-30455	2,19 €



Univerzálne vrtáky s 1/4" upínaním



Univerzálne vrtáky s 1/4" upínaním určené na vrtanie do kachličiek, tehly, keramiky, dreva, plastu, hliníku a železa.

3	90	1	E-14934	2,09 €
4	90	1	E-14940	2,09 €
5	100	1	E-14956	2,19 €
6	100	1	E-14984	2,39 €
6	150	1	E-14990	2,69 €
8	120	1	E-15045	3,19 €
8	150	1	E-15051	3,49 €
10	150	1	E-15067	4,19 €
12	150	1	E-15073	4,69 €



VRTANIE: VRTÁKY

ø mm	L1 mm	L2 mm	ks/bal	Obj. č.	MOC s DPH
------	-------	-------	--------	---------	-----------

Vrtáky do tehly s valcovitou stopkou



3	60	30	1	D-40727	1,29 €
3,5	75	40	1	D-40733	0,59 €
4	75	40	1	D-40749	0,59 €
5	85	50	1	D-40761	0,59 €
5	150	90	1	D-40777	0,79 €
6	100	60	1	D-40808	0,79 €
6	150	90	1	D-40814	0,89 €
6	200	130	1	D-40820	1,19 €
6	400	300	1	D-40836	1,89 €
6,5	100	60	1	D-40842	0,59 €
8	120	80	1	D-40901	0,89 €
8	150	90	1	D-40917	1,29 €
8	200	130	1	D-40923	1,49 €
8	400	300	1	D-40939	9,39 €
9	120	80	1	D-40945	0,89 €
10	120	80	1	D-40951	1,59 €
10	150	90	1	D-40967	1,29 €
10	200	130	1	D-40973	1,99 €
10	400	300	1	D-40989	2,89 €
12	150	90	1	D-41006	1,59 €
12	200	130	1	D-41012	2,09 €
12	400	300	1	D-41028	3,69 €

Sada vrtákov HM CT do muriva s valcovitou stopkou E-11536 8,89 € (MOC s DPH)

- 4 x 70 mm
- 5 x 85 mm
- 6 x 100 mm
- 8 x 110 mm
- 10 x 150 mm



Sada vrtákov TCT s valcovitou stopkou E-14255 14,19 € (MOC s DPH)

- Ø4 x 75 mm
- Ø5 x 80 mm
- Ø6 x 100 mm
- Ø8 x 120 mm
- Ø10 x 150 mm

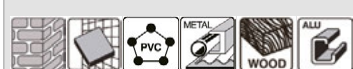

Sada vrtákov TCT s valcovitou stopkou pre rôzne druhy materiálov E-15855 23,19 € (MOC s DPH)

- Ø3 x 70 mm; Ø6 x 150 mm
- Ø4 x 75 mm; Ø8 x 120 mm
- Ø5 x 85 mm; Ø8 x 150 mm
- Ø6 x 100 mm; Ø10 x 150 mm

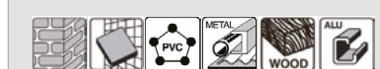
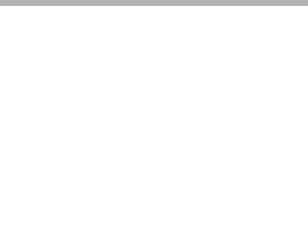

PRÍSLUŠENSTVO

▣ Vrtanie (búranie)

NEMESIS II



Železo, mäkká oceľ



Hliník



Drevo



Obklad



Betón



Armovaný betón



Tehla



Žula



PVC



Asfalt



Dvoj brit



Štvor brit



Samoostrenie



Menej prachu



Hrot z karbidu volfrámu

ø mm	L1 mm	L2 mm	ks/bal	Obj. č.	MOC s DPH
------	-------	-------	--------	---------	-----------

NEMESIS II SDS-PLUS 4brit



5	115	50	1	B-57897	5,79 €
5	165	100	1	B-57906	6,19 €
5	215	150	1	B-57912	8,89 €
5,5	115	50	1	B-57940	5,89 €
5,5	165	100	1	B-57956	6,29 €
6	115	50	1	B-57962	5,89 €
6	165	100	1	B-57978	6,29 €
6	215	150	1	B-57984	7,99 €
6	265	200	1	B-57990	9,69 €
6	315	250	1	B-58001	13,29 €
6,5	165	100	1	B-58023	8,09 €
6,5	215	150	1	B-58039	10,79 €
6,5	265	200	1	B-58045	13,59 €
6,5	315	250	1	B-58051	15,69 €
7	115	50	1	B-58067	7,69 €
7	165	100	1	B-58073	8,09 €
7	215	150	1	B-58089	9,79 €
8	115	50	1	B-58095	6,79 €
8	165	100	1	B-58104	7,19 €
8	215	150	1	B-58110	8,09 €
8	265	200	1	B-58126	9,69 €
8	315	250	1	B-58132	12,69 €
8	465	400	1	B-58154	20,39 €
9	165	100	1	B-58176	7,59 €
9	265	200	1	B-58182	9,49 €
10	115	50	1	B-58198	7,29 €
10	165	100	1	B-58207	7,89 €
10	215	150	1	B-58213	8,89 €
10	265	200	1	B-58229	10,19 €
10	315	250	1	B-58235	12,49 €
10	455	390	1	B-58257	21,59 €
10	600	540	1	B-58263	26,59 €
10	1000	940	1	B-58279	66,19 €
11	160	110	1	E-14495	8,39 €
11	210	160	1	E-14504	10,09 €
11	260	210	1	E-14510	11,89 €
11	310	260	1	B-58316	16,49 €
12	160	110	1	E-14532	7,99 €
12	165	100	5	E-14794	38,99 €
12	215	150	5	E-14803	47,49 €
12	265	200	5	E-14819	55,29 €
12	165	100	10	E-14825	78,59 €
12	215	150	10	E-14831	95,89 €
12	265	200	10	E-14847	108,69 €
12	315	250	10	E-14853	149,19 €
12	210	160	1	E-14548	9,79 €
12	260	210	1	E-14554	11,09 €
12	310	260	1	E-14560	15,49 €
12	450	400	1	E-14576	22,79 €
12	600	550	1	E-14582	29,09 €
12	1000	950	1	E-19598	69,59 €
13	210	160	1	B-58403	18,19 €
13	260	210	1	B-58419	20,39 €
13	310	260	1	E-14629	21,49 €
14	165	100	10	E-14869	113,79 €
14	215	150	10	E-14875	151,39 €
14	265	200	10	E-14881	173,89 €
14	315	250	10	E-14897	187,09 €
14	160	110	1	E-14635	11,59 €
14	210	160	1	E-14641	15,39 €
14	260	210	1	E-14657	17,69 €
14	310	260	1	E-14663	18,99 €
14	450	400	1	E-14679	23,79 €
14	600	550	1	E-14685	31,89 €
14	1000	950	1	B-58497	72,19 €
15	160	110	1	E-14691	17,69 €
15	210	160	1	E-14700	19,89 €
15	260	210	1	E-14716	21,79 €
15	450	400	1	B-58534	29,39 €
16	160	110	1	E-14738	18,49 €
16	210	160	1	E-14744	20,69 €
16	260	210	1	E-14750	22,99 €
16	310	260	1	E-14766	24,49 €
16	450	400	1	E-14772	29,99 €
16	600	550	1	E-14788	39,09 €
16	1000	950	1	E-19613	82,09 €
18	250	200	1	B-58615	30,59 €
18	450	400	1	B-58621	34,69 €
20	250	200	1	B-58637	32,99 €
20	450	400	1	B-58659	39,69 €
22	250	200	1	B-58665	37,39 €
22	450	400	1	B-58687	48,59 €
24	250	200	1	B-58693	46,69 €
24	450	400	1	B-58702	53,19 €
25	250	200	1	B-58718	47,59 €
25	450	400	1	B-58724	60,99 €
28	250	200	1	B-58746	56,09 €
28	450	400	1	B-58752	71,79 €
30	250	200	1	B-58768	62,99 €
30	450	400	1	B-58774	75,09 €
32	450	400	1	B-58780	82,89 €

Sada vrtákov SDS – plus 4 brit

E-14249

16,59 € (MOC s DPH)

- Ø5 x 110 mm
- Ø6 x 160 mm
- Ø8 x 160 mm
- Ø10 x 160 mm



VŔTANIE: PRÍKLEPOVÉ VRTÁKY SDS-PLUS

NEMESIS II SDS-PLUS 4brit – sady



Sada NEMESIS II **B-58986** **18,29 €** (MOC s DPH)

5 × 110 mm 1 ks
6 × 110 mm 1 ks
8 × 110 mm 1 ks

Sada NEMESIS II **B-59075** **20,99 €** (MOC s DPH)

6 × 160 mm 1 ks
8 × 160 mm 1 ks
10 × 160 mm 1ks

Sada NEMESIS II **B-58992** **31,09 €** (MOC s DPH)

5 × 110 mm 1 ks
6 × 110 mm 1 ks
6 × 160 mm 1 ks
8 × 160 mm 1 ks
10 × 160 mm 1 ks

Sada NEMESIS II **E-14912** **78,69 €** (MOC s DPH)

5 × 160 mm 1 ks
6 × 160 mm 3 ks
8 × 160 mm 3 ks
10 × 160 mm 3 ks
12 × 160 mm 2 ks

Sada NEMESIS II **E-14928** **52,89 €** (MOC s DPH)

5 × 110 mm 1ks
6 × 110 mm 1 ks
8 × 110 mm 1ks
6 × 160 mm 1ks
8 × 160 mm 1ks
10 × 160 mm 1ks
12 × 160mm 1 ks

Sada NEMESIS II **B-58827** **27,59 €** (MOC s DPH)

6 × 160 mm 5 ks / bal

Sada NEMESIS II **B-58899** **31,69 €** (MOC s DPH)

8 × 160 mm 5 ks / bal

Sada NEMESIS II **B-58914** **34,99 €** (MOC s DPH)

10 × 160 mm 5 ks / bal

ø mm	L1 mm	L2 mm	ks/bal	Obj. č.	MOC s DPH
------	-------	-------	--------	---------	-----------

Príkľepové vrtáky SDS-PLUS 4brit



6	110	50	1	B-62496	3,09 €
6	160	100	1	B-62505	3,39 €
6	210	150	1	B-62511	3,09 €
6	260	200	1	B-62527	3,69 €
8	160	100	1	B-62614	3,99 €
8	210	150	1	B-62620	4,29 €
8	260	200	1	B-62636	4,59 €
8	310	250	1	B-62642	4,89 €
8	460	400	1	B-62658	8,59 €
10	160	100	1	B-62670	4,89 €
10	210	150	1	B-62686	5,39 €
10	260	200	1	B-62692	6,39 €
10	310	250	1	B-62701	6,69 €
10	350	290	1	B-62717	6,99 €
10	460	400	1	B-62723	10,49 €
12	210	150	1	B-62745	7,49 €
12	260	200	1	B-62751	8,19 €
12	460	400	1	B-62789	11,79 €

VRTANIE: PRÍKLEPOVÉ VRTÁKY SDS-PLUS

Ideálne vrtáky na vrtanie s príklepom do betónu, muriva a prírodného kameňa. Moderné tepelné spracovanie a špeciálna technológia kalenia povrchu znižujú opotrebovanie a zaručujú vysokú húževnatosť a odolnosť vrtákov voči namáhaniu ohybom. Vhodné pre vrtacie kladivá triedy 2 – 4 kg.

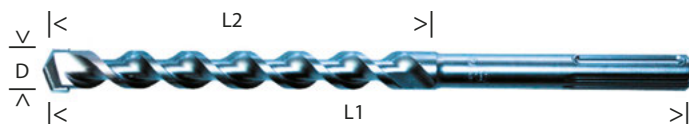

ø mm	L1 mm	L2 mm	ks/bal	Obj. č.	MOC s DPH	ø mm	L1 mm	L2 mm	ks/bal	Obj. č.	MOC s DPH
------	-------	-------	--------	---------	-----------	------	-------	-------	--------	---------	-----------

Príklepové vrtáky SDS-Plus V Plus



4	110	50	1	B-47232	3,39 €
4	160	100	1	B-47248	4,19 €
5	110	50	1	B-46492	2,69 €
5	160	100	1	B-46501	3,19 €
5	210	150	1	B-47260	5,09 €
5	310	250	1	B-47282	6,59 €
5,5	110	50	1	B-47298	2,99 €
5,5	160	100	1	B-47307	3,79 €
5,5	210	150	1	B-47313	4,99 €
5,5	260	200	1	B-47329	6,19 €
6	110	50	1	B-46517	2,69 €
6	160	100	1	B-46523	2,89 €
6	210	150	1	B-47341	4,29 €
6	260	200	1	B-47357	5,39 €
6	310	250	1	B-47363	9,19 €
6	460	400	1	B-47379	13,29 €
6,5	160	100	1	B-47391	3,79 €
6,5	210	150	1	B-47400	4,99 €
6,5	260	200	1	B-47416	6,69 €
6,5	310	250	1	B-47422	9,59 €
7	160	100	1	B-47444	3,39 €
7	210	150	1	B-47450	5,09 €
7	250	190	1	B-47466	6,89 €
8	110	50	1	B-46539	3,09 €
8	160	100	1	B-46545	3,39 €
8	210	150	1	B-47472	4,29 €
8	260	200	1	B-47488	4,89 €
8	310	250	1	B-47494	6,69 €
8	400	340	1	B-47503	9,99 €
8	460	400	1	B-47519	10,59 €
8	600	540	1	B-47525	15,69 €
9	160	100	1	B-47531	4,29 €
9	210	150	1	B-47547	5,69 €
9,5	160	100	1	B-47553	4,19 €
10	110	50	1	B-46551	3,49 €
10	160	100	1	B-46567	3,79 €
10	210	150	1	B-47569	4,89 €
10	260	200	1	B-47575	5,39 €
10	310	250	1	B-47581	6,89 €
10	350	290	1	B-47597	9,39 €
10	450	390	1	B-47606	10,39 €
10	600	540	1	B-47612	15,29 €
10	800	740	1	B-47628	23,59 €
10	1000	940	1	B-47634	39,99 €
11	160	110	1	B-47640	5,29 €
11	210	160	1	B-47656	6,29 €
11	260	210	1	B-47662	7,39 €
11	310	260	1	B-47678	9,09 €
12	160	110	1	B-46573	4,49 €
12	210	160	1	B-47684	5,59 €
12	260	210	1	B-47690	7,09 €
12	310	260	1	B-47709	8,99 €
12	360	310	1	B-47715	10,99 €
12	450	400	1	B-47721	12,59 €
12	600	550	1	B-47737	17,09 €
12	800	750	1	B-47743	27,29 €
12	1000	950	1	B-47759	44,29 €
13	160	110	1	B-47765	5,59 €
13	210	160	1	B-47771	7,09 €
14	160	110	1	B-46589	6,19 €
14	210	160	1	B-47802	7,19 €

14	260	210	1	B-47818	8,79 €
14	310	260	1	B-47824	9,69 €
14	450	400	1	B-47830	13,39 €
14	600	550	1	B-47846	18,79 €
14	1000	950	1	B-47852	45,59 €
15	160	110	1	B-47868	8,09 €
15	210	160	1	B-47874	9,39 €
15	260	210	1	B-47880	10,39 €
15	450	400	1	B-47896	16,09 €
16	160	110	1	B-47905	7,89 €
16	210	160	1	B-47911	9,29 €
16	260	210	1	B-47927	10,89 €
16	310	260	1	B-47933	12,69 €
16	450	400	1	B-47949	17,49 €
16	600	550	1	B-47955	21,39 €
16	800	750	1	B-47961	31,49 €
16	1000	950	1	B-47977	47,49 €
18	200	150	1	B-48000	14,29 €
18	300	250	1	B-48016	17,29 €
18	450	400	1	B-48022	22,19 €
18	600	550	1	B-48038	30,69 €
18	1000	950	1	B-48044	56,19 €
20	200	150	1	B-48072	17,89 €
20	300	250	1	B-48088	20,19 €
20	450	400	1	B-48094	26,39 €
20	600	550	1	B-48103	34,99 €
20	800	750	1	B-48119	60,49 €
20	1000	950	1	B-48125	66,09 €
22	250	200	1	B-48131	24,59 €
22	450	400	1	B-48147	33,99 €
22	600	550	1	B-48153	43,89 €
22	1000	950	1	B-48169	70,79 €
24	250	200	1	B-48197	30,49 €
24	450	400	1	B-48206	37,19 €
24	600	550	1	B-48212	44,49 €
25	250	200	1	B-48228	33,09 €
25	450	400	1	B-48234	38,49 €
25	600	550	1	B-48240	57,39 €
25	1000	950	1	B-48256	85,69 €
26	250	200	1	B-48262	32,79 €
26	450	400	1	B-48278	39,89 €

Sada vrtákov SDS plus 2 brit

D-74136

8,99 € (MOC s DPH)

5 x 110 mm
6 x 160 mm
8 x 160 mm
10 x 160 mm



Sada vrtákov SDS plus 2 brit

D-74756

9,29 € (MOC s DPH)

Ø 6; 8; 10; 12 x 160 mm



VŔTANIE: PRÍKLEPOVÉ VRTÁKY SDS-PLUS

ø mm	L1 mm	L2 mm	ks/bal	Obj. č.	MOC s DPH
------	-------	-------	--------	---------	-----------

Príklepové vrtáky SDS-Plus V Plus



Ideálne vrtáky na vrtanie s príklepom do betónu, muriva a prírodného kameňa. Moderné tepelné spracovanie a špeciálna technológia kalenia povrchu znižujú opotrebovanie a zaručujú vysokú húževnatosť a odolnosť vrtákov voči namáhaniu ohybom. Vhodné pre vrtacie kladivá triedy 2 – 4 kg.



5	110	50	5	B-46492-5	13,29 €
6	110	50	5	B-46517-5	13,29 €
6	160	100	5	B-46523-5	14,19 €
6	210	150	5	B-47341-5	21,29 €
8	110	50	5	B-46539-5	15,39 €
8	160	100	5	B-46545-5	16,89 €
8	210	150	5	B-47472-5	21,79 €
10	160	100	5	B-46567-5	19,49 €
10	210	150	5	B-47569-5	25,19 €
12	160	110	5	B-46573-5	23,19 €
12	210	160	5	B-47684-5	28,89 €
6	110	50	10	B-46517-10	25,79 €
6	210	200	10	B-47341-10	42,49 €
8	160	100	10	B-46545-10	33,29 €
8	210	150	10	B-47472-10	42,49 €
10	160	110	10	B-46567-10	37,19 €
6	160	100	25	B-46523-25	67,79 €
8	210	150	25	B-47472-25	103,89 €
10	210	150	25	B-47569-25	120,79 €
6	110	50	50	B-46517-50	124,99 €
6	160	100	50	B-46523-50	133,89 €
8	160	100	50	B-46545-50	162,29 €
8	210	150	50	B-47472-50	205,59 €
10	160	100	50	B-46567-50	181,79 €

Sada vrtákov SDS-Plus V-Plus B-49052 15,49 € (MOC s DPH)

- 5x110 1 ks
- 6x110 1 ks
- 8x110 1 ks
- 6x160 1 ks
- 8x160 1 ks

Sada vrtákov SDS-Plus V-Plus B-49074 18,39 € (MOC s DPH)

- 5x110 1 ks
- 6x160 1 ks
- 8x160 1 ks
- 10x160 1 ks
- 12x160 1 ks

Sada vrtákov SDS-Plus V-Plus B-49080 48,59 € (MOC s DPH)

- 6x110 1 ks
- 6x160 2ks
- 8x160 3 ks
- 10x160 2 ks
- 12x160 2 ks
- 14x160 1 ks
- 16x160 1 ks

Sada vrtákov SDS-Plus V-Plus B-49096 37,79 € (MOC s DPH)

- 5x110 3 ks
- 6x160 4 ks
- 8x160 2 ks
- 10x160 2 ks
- 12x160 1 ks

Sada vrtákov SDS-Plus V-Plus B-49105 41,79 € (MOC s DPH)

- 6x160 3 ks
- 8x160 4 ks
- 10x160 3 ks
- 12x160 2 ks

Sada vrtákov SDS-Plus V-Plus B-49133 15,29 € (MOC s DPH)

- 5x110 1 ks
- 6x110 1 ks
- 6x160 1 ks
- 8x160 1 ks
- 10x160 1 ks

Sada vrtákov SDS-Plus V-Plus B-49127 35,89 € (MOC s DPH)

- 5x110 1 ks
- 6x110 1 ks
- 6x160 2 ks
- 8x160 2 ks
- 10x160 2 ks
- 10x210 1 ks
- 12x210 1 ks

Sada vrtákov SDS-Plus V-Plus B-49046 31,89 € (MOC s DPH)

- 5x110 1 ks
- 6x110 1 ks
- 6x160 1 ks
- 8x110 1 ks
- 8x160 1 ks
- 10x160 1 ks
- 12x160 1 ks

Ľahké príklepové vrtacie korunky SDS-Plus



Použitie do muriva, moderných ľahkých stavebných hmôt a betónu.



popis	ø mm	obj. č.	MOC s DPH
ľahké vrtacie korunky M16	40	P-26191	58,79 €
	50	P-26200	62,79 €
	65	P-26216	63,69 €
	80	P-26222	71,29 €
vystreďovací vrták pre vrtacie korunky		P-64347	5,29 €
upínacia stopka pre vrtacie korunky		P-67745	22,89 €

Akumulátory
Odkladacie systémy
Vrtanie
Skrutkovanie
Brúsky
Pílenie
Frézovanie
Brúsenie
Klince / spony
Špeciálne stroje
Vysávanie
Fény/lampy
Záhradná
Ručné náradie
Ostatné

VRTANIE: PRÍKLEPOVÉ VRTÁKY SDS-PLUS

ø mm	L1 mm	L2 mm	ks/bal	Obj. č.	MOC s DPH
------	-------	-------	--------	---------	-----------

Príklepové vrtáky SDS-Plus V Plus



Vhodné na vrtanie s príklepom do betónu, muriva a prírodného kameňa. Tieto robustné príklepové vrtáky SDS-PLUS sú cenovo výhodnou alternatívou vrtákov SDS-PLUS S4. Sú optimálne pre príležitostné vrtanie.

ø mm	L1 mm	L2 mm	ks/bal	Obj. č.	MOC s DPH
4	160	100	1	D-66612	1,59 €
5	210	150	1	D-66628	1,89 €
6,5	260	200	1	D-66634	2,29 €
8	310	250	1	D-66640	3,29 €
10	350	290	1	D-66656	3,19 €
11	210	150	1	D-66662	2,29 €
11	260	200	1	D-66678	2,59 €
12	310	250	1	D-66684	3,69 €
13	210	150	1	D-66690	2,99 €
14	310	250	1	D-66709	4,19 €

Sada vrtákov SDS-Plus V-Plus **D-00795** **8,89 €** (MOC s DPH)

5 × 110 mm 1 ks	
6 × 110 mm 1 ks	
8 × 110 mm 1 ks	
6 × 160 mm 1 ks	
8 × 160 mm 1 ks	

Sada vrtákov SDS-Plus V-Plus **D-62723** **20,59 €** (MOC s DPH)

6 × 160 mm 3 ks	
8 × 160 mm 3 ks	
10 × 160 mm 3 ks	
12 × 160 mm 3 ks	

Sada vrtákov SDS-Plus V-Plus **D-61678** **8,49 €** (MOC s DPH)

6 × 110 mm 1 ks	
6 × 160 mm 1 ks	
8 × 110 mm 1 ks	
8 × 160 mm 1 ks	
10 × 160 mm 1 ks	

3,5	90	30	1	D-16950	1,69 €
4	110	50	1	D-00016	1,79 €
5	110	50	1	D-00022	1,79 €
5	160	100	1	D-00038	1,79 €
5,5	110	50	1	D-00044	1,79 €
6	110	50	1	D-00050	1,79 €
6	160	100	1	D-00066	1,89 €
6	210	150	1	D-00072	2,19 €
6,5	110	50	1	D-00088	1,59 €
6,5	160	100	1	D-00094	1,69 €
7	110	50	1	D-00103	1,79 €
7	160	100	1	D-00119	1,59 €
8	110	50	1	D-00125	1,79 €
8	160	100	1	D-00131	1,89 €
8	210	150	1	D-00147	2,29 €
8	260	200	1	D-00153	2,59 €
9	210	150	1	D-00169	2,19 €
10	160	100	1	D-00175	1,99 €
10	210	150	1	D-00181	2,29 €
10	260	200	1	D-00197	2,79 €
10	310	250	1	D-00206	3,29 €
10	460	400	1	D-17538	6,59 €
11	160	100	1	D-00212	1,29 €
12	160	100	1	D-00228	2,29 €
12	210	150	1	D-00234	2,69 €
12	260	200	1	D-00240	2,99 €
12	460	400	1	D-16271	6,89 €
13	160	100	1	D-00256	1,89 €
14	160	100	1	D-00262	2,89 €
14	260	200	1	D-00278	3,89 €
14	460	400	1	D-17544	6,99 €
15	160	100	1	D-00284	3,29 €
15	460	400	1	D-17550	8,49 €
16	210	150	1	D-00290	3,99 €
16	460	400	1	D-16287	8,09 €
16	310	250	1	D-00309	5,39 €
17	210	150	1	D-00315	4,59 €
18	210	150	1	D-00321	4,69 €
18	300	240	1	D-00337	5,59 €
18	460	400	1	D-17566	9,59 €
19	210	150	1	D-00343	3,69 €
19	460	400	1	D-16293	8,29 €
20	210	150	1	D-00359	6,49 €
20	310	250	1	D-00365	8,29 €
20	460	400	1	D-15235	11,29 €
22	260	200	1	D-00371	6,79 €
22	310	250	1	D-08062	7,99 €
22	460	400	1	D-15241	12,29 €
24	460	400	1	D-16302	13,29 €
25	260	200	1	D-00387	10,09 €
25	310	250	1	D-08517	10,99 €
25	460	400	1	D-15257	14,49 €
26	260	200	1	D-00393	10,79 €
26	310	250	1	D-08078	11,79 €
26	460	400	1	D-15263	17,19 €
28	460	400	1	D-16318	18,39 €
30	460	400	1	D-17572	25,59 €

Sada vrtákov a sekáčov SDS-Plus V-Plus **D-58920** **22,49 €** (MOC s DPH)

5 × 160 mm 1 ks	
6 × 160 mm 1 ks	
8 × 160 mm 1 ks	
sekáč špic 250 mm	
sekáč plochý 20 × 250 mm	
sekáč plochý 40 × 250 mm	

VŔTANIE: PRÍKLEPOVÉ VRTÁKY SDS-MAX



Štvorbřité vrtáky ZENTRO MAX sú dokonalou kombináciou nového inovatívneho tvaru hlavy vrtáka so špeciálnym tvarom špirály zaručujúcu nekompromisnú kvalitu v každom detaile. Tieto vrtáky sa vyznačujú veľmi dlhou životnosťou, veľkou presnosťou a ideálnym prenosom energie zo stroja na hrot vrtáku.

Kvalitu týchto vrtákov ocenia hlavne majstri, ktorí potrebujú vrtáť do tvrdých materiálov – betónu, železobetónu alebo prírodného kameňa.



Vrtáky sú cenovo výhodnou variantou a sú určené pre vrtanie do betónu, muriva a prírodného kameňa.

ø mm	L1 mm	L2 mm	ks/bal	Obj. č.	MOC s DPH
------	-------	-------	--------	---------	-----------

ø mm	L1 mm	L2 mm	ks/bal	Obj. č.	MOC s DPH
------	-------	-------	--------	---------	-----------

Príkľepové štvorbřité vrtáky ZENTRO MAX *****

Príkľepové vrtáky SDS-MAX V-Plus ****

12	*340	200	1	P-17033	34,99 €
12	*540	400	1	P-17049	43,69 €
12	*690	550	1	P-17055	64,29 €
14	*340	200	1	P-17077	39,39 €
14	*540	400	1	P-17083	46,09 €
15	*340	200	1	P-17108	40,79 €
16	340	200	1	P-77730	40,79 €
16	540	400	1	P-77746	46,79 €
16	920	800	1	P-77752	70,19 €
16	1320	1200	1	P-77768	178,89 €
18	340	200	1	P-77774	42,99 €
18	540	400	1	P-77780	49,29 €
18	920	800	1	P-77796	73,59 €
18	1320	1200	1	P-77805	180,99 €
20	320	200	1	P-77811	44,49 €
20	520	400	1	P-77827	51,39 €
20	920	800	1	P-77833	78,59 €
20	1320	1200	1	P-77849	185,69 €
22	520	400	1	P-77861	56,39 €
22	920	800	1	P-77877	84,99 €
24	320	200	1	P-77899	55,59 €
24	520	400	1	P-77908	64,29 €
25	320	200	1	P-77914	55,99 €
25	520	400	1	P-77920	62,59 €
25	920	800	1	P-77936	98,59 €
25	1320	1200	1	P-77942	207,89 €
26	520	400	1	P-77958	69,99 €
28	370	200	1	P-77964	62,49 €
28	570	450	1	P-77970	70,79 €
28	670	550	1	P-77986	97,29 €
28	920	800	1	P-77992	114,59 €
28	1320	1200	1	P-78003	216,79 €
30	370	250	1	P-78019	67,49 €
30	570	450	1	P-78025	76,59 €
32	370	250	1	P-78031	71,99 €
32	570	450	1	P-78047	86,49 €
32	920	800	1	P-78053	133,39 €
32	1320	1200	1	P-78069	224,29 €
35	370	250	1	P-78075	86,39 €
35	570	450	1	P-78081	98,69 €
35	670	550	1	P-78097	122,19 €
35	1320	1200	1	P-78592	244,29 €
37	570	450	1	P-78112	118,69 €
37	920	800	1	P-78128	169,99 €
38	370	250	1	P-78134	102,39 €
38	570	450	1	P-78140	123,79 €
40	370	250	1	P-78156	122,79 €
40	570	450	1	P-78162	147,49 €
40	920	800	1	P-78178	199,29 €
40	1320	1200	1	P-78184	270,29 €
45	570	450	1	B-20323	229,49 €
45	920	800	1	P-78209	257,19 €
50	570	450	1	P-78215	238,49 €

12	340	200	1	D-33875	12,79 €
12	540	400	1	D-33881	17,29 €
14	340	200	1	D-33897	12,39 €
14	540	400	1	D-33906	20,79 €
15	340	200	1	D-33912	11,59 €
15	540	400	1	D-33928	15,49 €
16	340	200	1	D-33934	13,89 €
16	540	400	1	D-33940	18,99 €
18	340	200	1	D-33956	17,39 €
18	540	400	1	D-33962	21,59 €
20	340	200	1	D-33978	19,59 €
20	540	400	1	D-33984	27,49 €
22	340	200	1	D-33990	16,19 €
22	540	400	1	D-34001	27,99 €
24	340	200	1	D-34017	16,69 €
24	540	400	1	D-34023	27,99 €
25	340	200	1	D-34039	22,89 €
25	540	400	1	D-34045	29,69 €
28	370	250	1	D-34051	24,99 €
28	570	450	1	D-34067	40,29 €
30	370	250	1	D-34073	30,59 €
30	570	450	1	D-34089	48,49 €
32	370	250	1	D-34095	36,69 €
32	570	450	1	D-34104	55,49 €
35	370	250	1	D-34110	42,59 €
35	570	450	1	D-34126	62,89 €
38	370	250	1	D-34132	58,89 €
38	570	450	1	D-34148	74,69 €
40	370	250	1	D-34154	65,79 €
40	570	450	1	D-34160	81,99 €

Adaptér SDS-MAX na SDS-PLUS P-17027 88,49 € (MOC s DPH)



Rýchlosťúčovadlo s upínaním SDS-Max 122829-5 63,69 € (MOC s DPH)



*Priemery 12 – 15 mm sa dodávajú s dvomi ostriami.

VRTANIE: VRTANIE SDS-MAX

ø mm	L1 mm	L2 mm	ks/bal	Obj. č.	MOC s DPH
------	-------	-------	--------	---------	-----------

Vrtacie korunky SDS-MAX



Vrtacie korunky Makita sú ideálne vhodné na vrtanie do betónu, muriva a prírodného kameňa. Veniec vrtacej korunky je osadený symetricky usporiadanými, pevnými špeciálnymi zubami z tvrdého kovu. Priamy prenos energie príklepu umožňuje dosahovať rýchly postup vrtania. Účinná vonkajšia drážka v tvare špirály minimalizuje stratu trením, umožňuje rýchly odsun odvráteného prachu a je zárukou dlhej životnosti.



40	100		1	P-03779	92,59 €
50	100		1	P-03785	109,59 €
65	100		1	P-03791	130,29 €
68	100		1	P-73433	133,89 €
80	100		1	P-03800	146,89 €
100	100		1	P-03822	201,49 €
110	100		1	P-73449	232,69 €
125	100		1	P-16374	275,49 €
vystredovací vrták pre vrtacie korunky		11 x 120	1	P-03838	9,09 €
upínacia stopka pre vrtacie korunky		180	1	P-16994	50,09 €
		450	1	P-17005	71,99 €
vyrážací klin pre vrtacie korunky		140	1	P-03763	8,59 €

68	80	290	1	P-64406	194,29 €
----	----	-----	---	---------	----------

Potrebné dokúpiť strediaci vrták P-03838

Prerážacie vrtáky SDS-MAX



Výkonové parametre prerážacích vrtákov Makita do betónu:

- Rýchla montáž – nástroj je z jedného kusu
- Vyrvtanie celého priemeru – vylamovanie jadra nie je potrebné
- Jednoduchá konštrukcia umožňuje prenos energie príklepu na špičku nástroja bez strát v dôsledku útlmu
- Variabilná hĺbka vrtu podľa dĺžky stopky
- Rovná a okrúhla diera s plochým dnom
- Výrazne vyšší vrtací výkon ako s vrtacími korunkami



40	prerážacie vrtáky so závitovým čapom		1	P-03844	145,99 €
50			1	P-03850	182,29 €
55			1	P-04014	219,79 €
60			1	P-04020	228,49 €
90			1	P-04036	397,49 €
predĺženie Ratio pre prerážacie vrtáky		280	1	P-03925	106,29 €
upínacia stopka pre prerážacie vrtáky		185	1	P-03888	66,79 €
závitový čap		60	1	P-03931	15,49 €

40		550	1	E-20080	cena na vyžiadanie
45		550	1	E-20096	cena na vyžiadanie
45		990	1	E-20105	263,09 €
55		550	1	E-20111	251,59 €
55		990	1	E-20127	296,29 €
65		550	1	E-20133	275,49 €
65		990	1	E-20149	322,19 €
80		550	1	E-20155	306,09 €
80		990	1	E-20161	409,49 €

System MAXCONNET

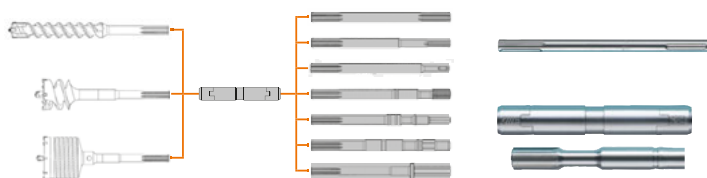

	320	predĺženie SDS-MAX = SDS-MAX	1	P-53920	31,19 €
	750	predĺženie SDS-MAX = SDS-MAX	1	P-53936	38,99 €
	1100	predĺženie SDS-MAX = SDS-MAX	1	P-53942	52,39 €
30	190	Adaptér SDS-MAX	1	P-53914	242,99 €
	320	predĺženie BOSCH	1	P-53958	34,89 €

s klin. hriadeľom = SDS-MAX

Sekáče SDS-PLUS



ø mm	L1 mm	L2 mm	ks/bal	Obj. č.	MOC s DPH
------	-------	-------	--------	---------	-----------

Sekáč špic SDS-PLUS so šesťhrannou stopkou *********

250	190	1	P-05505	11,29 €
-----	-----	---	---------	---------

Sekáč špic SDS-PLUS so šesťhrannou stopkou ********

400	340	1	D-19015	4,99 €
-----	-----	---	---------	--------

Sekáč plochý SDS-PLUS so šesťhrannou stopkou *********

20	250	190	1	P-05511	11,29 €
----	-----	-----	---	---------	---------

40	250	190	1	P-05527	16,79 €
----	-----	-----	---	---------	---------

40	250	190	1	B-14059	16,09 €
----	-----	-----	---	---------	---------

Sekáč drážkovací SDS-PLUS so šesťhrannou stopkou *********

22	250	190	1	P-05533	18,59 €
----	-----	-----	---	---------	---------

Sekáč plochý SDS-PLUS so šesťhrannou stopkou ********

20	400	340	1	D-19021	5,19 €
----	-----	-----	---	---------	--------

20	250	190	1	D-08729	5,09 €
----	-----	-----	---	---------	--------

40	250	190	1	D-08735	6,69 €
----	-----	-----	---	---------	--------

Sekáč špic SDS-PLUS s valcovitou stopkou *********

250	190	1	P-25068	7,69 €
-----	-----	---	---------	--------

Sekáč plochý SDS-PLUS so valcovitou stopkou *********

20	250	190	1	P-25074	7,69 €
----	-----	-----	---	---------	--------

40	250	190	1	A-30483	12,09 €
----	-----	-----	---	---------	---------

60	250	190	1	P-24935	19,99 €
----	-----	-----	---	---------	---------

Sekáč plochý SDS-PLUS s valcovitou stopkou ********

80	250	190	1	D-61020	17,99 €
----	-----	-----	---	---------	---------

Sekáč plochý zahnutý SDS-PLUS s valcovitou stopkou *********

40	250	190	1	P-24941	14,19 €
----	-----	-----	---	---------	---------

40	250	190	1	P-63987	19,89 €
----	-----	-----	---	---------	---------

60	250	190	1	P-24957	21,19 €
----	-----	-----	---	---------	---------

Sekáč drážkovací SDS-PLUS s valcovitou stopkou *********

22	250	190	1	P-25080	14,89 €
----	-----	-----	---	---------	---------

Sekáč krídelkový SDS-PLUS s valcovitou stopkou *********

22	250	190	1	P-24963	34,29 €
----	-----	-----	---	---------	---------

Dláto na dlabanie do dreva SDS-PLUS *********

30	170	110	1	P-25111	32,69 €
----	-----	-----	---	---------	---------

ø mm	L1 mm	L2 mm	ks/bal	Obj. č.	MOC s DPH
------	-------	-------	--------	---------	-----------

Sekáče SDS-MAX



Sekáč špic SDS-MAX



	280	220	1	P-16237	10,29 €
	400	330	1	P-16243	13,09 €
	600	520	1	P-16259	20,69 €

Sekáč plochý SDS-MAX



25	280	220	1	P-16265	10,29 €
25	400	330	1	P-16271	13,09 €
25	600	520	1	P-16287	20,69 €
50	360	300	1	P-16302	18,69 €
80	300	240	1	P-16318	28,39 €

Sekáč na kachličky SDS-MAX



50	300	240	1	P-16324	28,49 €
----	-----	-----	---	---------	---------

Sekáč drážkovací SDS-MAX



26	300	120	1	P-16293	31,79 €
----	-----	-----	---	---------	---------

Sekáč krídelkový SDS-MAX



35	360	190	1	P-16330	62,49 €
----	-----	-----	---	---------	---------

Sekáč lopatka SDS-MAX



100	400		1	P-23721	65,59 €
-----	-----	--	---	---------	---------

Sekáč škárový SDS-MAX



38	300		1	P-16346	91,19 €
----	-----	--	---	---------	---------

Zarovnávací platnička



Upínacia stopka pre zarovnávaciu platničku SDS-MAX

60	60	7 x 7 zubov	1	P-03947	101,79 €
	250		1	P-16352	36,59 €

Sekáč špic SDS-MAX



	300	240	1	D-34176	8,09 €
	400	330	1	D-34182	8,89 €
	600	520	1	D-34198	11,19 €

Sekáč plochý SDS-MAX



25	300	240	1	D-34207	7,99 €
25	400	330	1	D-34213	9,09 €
25	600	520	1	D-34229	12,99 €
50	400	300	1	D-34235	11,29 €
80	300	240	1	D-34241	18,39 €

Samoostriace sekáče SDS-MAX



50	350	190	1	B-14015	24,49 €
	400	330	1	B-23064	17,39 €

Samoostriaci sekáč špic šesťhran 28 mm (HM1304B, HM1307 CB, HM1801, HM1810)



	400		1	B-10372	32,99 €
--	-----	--	---	---------	---------

Samoostriaci sekáč špic šesťhran 30 mm (HM1304B, HM1307 CB, HM1801, HM1810)



	400		1	B-10388	40,49 €
--	-----	--	---	---------	---------

Sada sekáčov SDS-MAX



špic	400		5	D-35324-10	63,69 €
25	400		5		

Sady sekáčov a vrtákov SDS-PLUS

Sada sekáčov a vrtákov SDS-PLUS 10 ks **D-42385** **62,29 €** (MOC s DPH)

vrták \varnothing 6 x 110, 8 x 160, 10 x 210, 12 x 210 mm
 sekáč špic 250 mm
 sekáč plochý 20 x 250 mm



Sada sekáčov a vrtákov SDS-PLUS 10 ks **D-21191** **62,19 €** (MOC s DPH)

vrták \varnothing 5,5, 6 x 110 mm
 7, 8 x 160 mm
 10 x 210 mm
 10, 16, 20 x 460 mm
 sekáč špic 250 mm
 sekáč plochý 20 x 250 mm



Sada sekáčov a vrtákov SDS-PLUS 13 ks **D-20111** **48,29 €** (MOC s DPH)

vrták \varnothing 5, 6, 7, 8 x 110 mm
 6, 7, 8, 10, 12, 14, 16 x 160 mm
 sekáč špic 250 mm
 sekáč plochý 20 x 250 mm



Sada samoostriacích sekáčov SDS-PLUS 5 ks **E-13188** **50,69 €** (MOC s DPH)

sekáč plochý 40 x 250 mm
 sekáč plochý 20 x 250 mm 2 ks
 sekáč špic 250 mm 2 ks



Sady sekáčov a vrtákov SDS-PLUS 17 ks **D-42444** **60,29 €** (MOC s DPH)

vrták \varnothing 5, 6, 8, 10 x 110 mm
 6, 8, 10, 12, 14 x 160 mm
 8, 10 x 210 mm
 12 x 260 mm
 sekáč špic 140 mm
 sekáč špic 250 mm
 sekáč plochý 20 x 140 mm
 sekáč plochý 20 x 250 mm
 sekáč široký 40 x 250 mm



Sady sekáčov a vrtákov SDS-PLUS 17 ks **D-21200** **64,29 €** (MOC s DPH)

vrták \varnothing 5, 5,5, 6, 8, 10 x 110 mm
 6, 7, 8, 10 x 160 mm
 8, 10 x 210 mm
 14 x 260 mm
 sekáč špic 140 mm
 sekáč špic 250 mm
 sekáč plochý 20 x 140 mm
 sekáč plochý 20 x 250 mm
 sekáč široký 40 x 250 mm



Sada sekáčov SDS-PLUS 5 ks **D-16368** **43,49 €** (MOC s DPH)

sekáč špic 2 x 250 mm
 sekáč plochý 2 x 20 x 250 mm
 sekáč široký 40 x 250 mm



Sada sekáčov/vrtákov SDS-plus 10 ks **D-71990** **33,99 €** (MOC s DPH)

vrták \varnothing 5; 6; 8; 10; 12 x 160 mm
 10; 12; 16 x 210 mm
 sekáč špic 250 mm
 sekáč plochý 20 x 250 mm



Sady sekáčov a vrtákov SDS-MAX

Sada sekáčov SDS-MAX 6 ks **D-40565** **103,49 €** (MOC s DPH)

sekáč špic 2 x 400 mm
 sekáč plochý 2 x 25 x 400 mm
 sekáč plochý 50 x 400 mm
 sekáč plochý 80 x 300



Sada sekáčov SDS-MAX 5 ks **D-40618** **74,29 €** (MOC s DPH)

sekáč špic 3 x 400 mm
 sekáč plochý 2 x 25 x 400 mm



Sada sekáčov a vrtákov SDS-MAX 7 ks **D-42494** **136,99 €** (MOC s DPH)

vrták \varnothing 18, 20, 22, 25 x 540 mm
 sekáč špic 400 mm
 sekáč plochý 25 x 400 mm
 sekáč plochý 50 x 400 mm



Sada sekáčov SDS-MAX 3 ks **D-40543** **55,39 €** (MOC s DPH)

sekáč špic 400 mm
 sekáč plochý 25 x 400 mm
 sekáč plochý 50 x 400 mm



SEKANIE: SEKÁČE

ø mm	L1 mm	L2 mm	ks/bal	Obj. č.	MOC s DPH
------	-------	-------	--------	---------	-----------

Pre kladivá s upnutím Bosch 19 mm



Sekáč špic pre Bosch kladivá 19 mm bez odsústruženého konca

	400		1	P-05620	20,89 €
	600		1	P-05614	30,69 €

Sekáč plochý pre Bosch kladivá 19 mm bez odsústruženého konca

25	400		1	P-05636	20,89 €
----	-----	--	---	---------	---------

Sekáč špic pre Bosch kladivá 19 mm s odsústruženým koncom

	450		1	P-13138	24,99 €
--	-----	--	---	---------	---------

Sekáč plochý pre Bosch kladivá 19 mm s odsústruženým koncom

26	300		1	P-13144	16,69 €
----	-----	--	---	---------	---------

26	450		1	P-13150	24,99 €
----	-----	--	---	---------	---------

Pre kladivá s upnutím Bosch 28 mm



Sekacie nástroje pre HM1304B, HM1801, HM1810 HM1307CB, HM1317CB, HM1802/HM1812

	400		1	P-05692	37,09 €
--	-----	--	---	---------	---------

29	400		1	P-05723	37,79 €
----	-----	--	---	---------	---------

80	400		1	P-05701	68,29 €
----	-----	--	---	---------	---------

125	400		1	P-05717	93,59 €
-----	-----	--	---	---------	---------

Sekáč špic uchytenie šesťhran ø 28,6mm



	350		1	D-65034	38,09 €
--	-----	--	---	---------	---------

	410		1	D-17631	22,29 €
--	-----	--	---	---------	---------

Upínacia stopka Makita



17 mm šesťhranná

	280		1	P-13035	18,79 €
--	-----	--	---	---------	---------

17	280		1	P-13057	18,79 €
----	-----	--	---	---------	---------

17	450		1	P-13063	24,29 €
----	-----	--	---	---------	---------

Upínacia stopka Makita



30 mm šesťhranná upínacia stopka pre HM1304, HM1400, HM1307C, HM1317C

	400		1	P-05549	39,19 €
--	-----	--	---	---------	---------

	700		1	P-05561	59,39 €
--	-----	--	---	---------	---------

	1000		1	P-05577	100,19 €
--	------	--	---	---------	----------

32	400		1	P-13487	39,89 €
----	-----	--	---	---------	---------

32	700		1	P-05583	61,39 €
----	-----	--	---	---------	---------

115	400		1	P-13518	96,39 €
-----	-----	--	---	---------	---------

125	400		1	P-05555	101,59 €
-----	-----	--	---	---------	----------

200	ubijadlo s upínacou stopkou		1	A-31485	136,29 €
-----	-----------------------------	--	---	---------	----------

	ochranná čiapočka proti prachu, sekáče a upínacie stopky		1	P-05446	4,19 €
--	--	--	---	---------	--------

	ochranná čiapočka proti prachu		1	423154-0	0,59 €
--	--------------------------------	--	---	----------	--------

	prepravný vozík (HM1801/1810/1802/1812)		1	D-54972	264,19 €
--	---	--	---	---------	----------

SEKANIE: ŠPECIÁLNE PRÍSLUŠENSTVO PRE VŔTACIE A SEKACIE KLADIVÁ

Model	Obj. č.	MOC s DPH
-------	---------	-----------



Rukoväte	*****	
HR3540C, HR3541FC, HR4001C, HR4002, HR4010C, HR4011C, HR4501C, HR4510C, HR4511C	135209-6	20,69 €
DHR400, HR005G, HR4003C, HR4013C	123138-5	34,93 €
HM001G HM0870C, HM0871C	135332-7	15,41 €
HP1621, HP1630, HP1631, HP2051, HP2071, HR2440, HR2450, HR2470	135302-6	3,69 €
HR3200C, HR3210FCT	135197-7	22,09 €

Mazací tuk pre prevodovky a nástroje	*****	
mazací tuk pre prevodovky 30 g	181490-7	3,19 €
mazací tuk pre prevodovky 500 g	042040-2A	27,19 €
mazací tuk pre prevodovky 2,5 kg	042025-8A	79,39 €
mazací tuk na nástroje 100 ml	198993-4	8,89 €

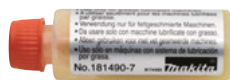

Mazací tuk pre prevodovky a nástroje	*****	
mazací tuk pre prevodovky 30 g	181490-7	3,19 €
mazací tuk pre prevodovky 500 g	042040-2A	27,19 €
mazací tuk pre prevodovky 2,5 kg	042025-8A	79,39 €
mazací tuk na nástroje 100 ml	198993-4	8,89 €

Adaptér	*****	
adaptér skľučovadla SDS-PLUS / 1/2" – 20 UNF	122573-4	10,69 €
adaptér + skľučovadlo SDS-PLUS	122574-2	36,69 €
Bitový adaptér 1/4"	P-21646	9,99 €



Protiprachový kryt pre stopku vŕtáka a sekáča	*****	
protiprachový kryt pre stopku vŕtáka a sekáča ø 10 – 18 mm	421664-1	2,39 €
ø 6 – 14 mm	421342-3	1,69 €



Odsávací adaptér	*****	
HR140D, HR166D, DHR164, DHR165, DHR171, DHR182, DHR202, DHR262, DHR263, DHR264, HR1840, HR2020, HR2022, HR2230, HR2460, HR2460F, HR2470, HR2470F, HR2470FT, HR2470T, HR2475, HR2800, HR2810, HR2810T, HR2811F, HR2811FT,	193472-7	48,79 €



vyfukovací balónik po vŕtaní	765009-6	2,29 €
------------------------------	----------	--------



Model	Obj. č.	MOC s DPH
-------	---------	-----------



Rukoväte	*****	
HR4001C, HR4002, HR4010C, HR4011C, HR4501C, HR4510C, HR4511C, HM1101C, HM1111C	134890-0	37,29 €
HR006G, HR5202C, HR5212C, HM1214C	135283-4	40,89 €
HM002G, HM1202C, HM1203C, HM1205C, HM1213C, HM1242C	135269-8	38,59 €
HR5001C	134945-1	36,59 €



Doraz hĺbkový	*****	
HP1630, HP1631, HP1640/F, HP1641/F, HP2050/F, HP2051/F, HP2070/F, HP2071/F	324219-0	0,58 €

Rýchlovýmenné skľučovadlo (vŕtanie)	*****	
HR2320T, HR2470T, HR2470FT, HR2630T, HR2631FT, HR2651T, HR2653T, HR2810T, HR2811FT, HR2450T, DHR243, DHR264	194079-2	58,09 €
DHR281, DHR283, HR002G, HR004G	199139-5	cena na vyžiadanie



Rýchlovýmenné skľučovadlo (SDS-PLUS)	*****	
HR2320T, HR2470T, HR2470FT, HR2630T, HR2631FT, HR2651T, HR2653T, HR2810T, HR2811FT, HR2450T, DHR243, DHR264	194080-7	46,29 €
HR3210FCT	194578-4	75,99 €
DHR281, DHR283, HR002G, HR004G	199138-7	27,19 €



Odsávací adaptér	*****	
DHR242, HR2650, HR2651, HR2652, HR2653, DHR281, DHR283, HR001G, HR003G, HR3012FC, HR2661, HR2663	195173-3	6,69 €
DHR243, HR2651T, HR2653T, HR2300T, HR2320T, HR2631FT, HR2630T, HR002G, HR004G	195179-1	8,39 €



Manžeta	*****	
DX05, DX06, DX07, DX08, DX09, DX12, DX14, HR2652, HR2653, HR2653T, HR2663	424474-5	0,79 €

PRÍSLUŠENSTVO K VŔTAČKÁM

klúč	popis	uchytenie	popis	Obj. č.	MOC s DPH
------	-------	-----------	-------	---------	-----------

Skľučovadlá s ozubeným vencom bez klúča



763418-3*	0,5 – 6,5	3/8"	6013BR, 6305, 6501/X	192887-5	15,09 €
763448-4*	1,5 – 13	1/2"	HP2050, HP2070, DP4010	193822-6	33,99 €
763418-3*	0,5 – 6,5	3/8"	DP2010	763077-3	6,59 €
763415-9	0 – 10	3/8"	BDA340, BDA350, DA3010F	763174-5	39,19 €
	1,5 – 13	1/2"	6013B, 6300-4, DP4700,	766016-2	9,89 €
763251-3*	2,0 – 13		DDA460, DGA460, DA001G, DG001G	763250-5	39,49 €

Klúč ku skľučovadlám



	10		DA3000, DA3000R	763414-1	2,39 €
	10		DA3010	763415-9	2,59 €
	10		6412	763418-3	1,09 €
	13		6305, 6013B/BR, 6300-4, DA4000LR, DA6301, UT1305, UT2204	763432-9	2,29 €
	13		DP4010, HP1620, HP1630, HP1640, HP2050, HP2070	763448-4	1,59 €
	10		6305, 6501/X, 6510LVR	P-04341	0,99 €
	13		DDA460, DGA460, DA001G, DG001G	763251-3	3,59 €
	13			A-86228	4,49 €

Rýchlopínacie skľučovadlá



	1,5 – 13		HP001G	136229-3	123,55 €
	1,5 – 13		DF001G	136232-4	110,04 €
	0,8 – 10	3/8"	6408, DA3011F	192016-0	26,29 €
	1,5 – 13	1/2"	6013B/BR, 6300-4, DP4001, DP4003, DP4700, HP1621, HP2051, HP2071	192685-7	38,89 €
	1,5 – 13	1/2"		193064-2	51,99 €
	1,5 – 13	1/2"	DP4011, HP2051, HP2071	194254-0	54,09 €
	1,5 – 13	1/2"	6390D, 8390D, HP1621, HP1631, HP1641	196193-0	23,29 €
	1,5 – 13	1/2"	6391D, DDF453, DHP453	196306-3	16,89 €
	1,0 – 10	1/2"	6260D, 6270D, 6280D	196307-1	16,09 €
	0,8 – 10	1/2"	8271D, 8281D, DHP343	763229-6	8,79 €
	1,5 – 13	1/2"	MT065	763182-6	15,09 €
	1,5 – 10	1/2"	6260D, 6270D, 6280D, 6207D, 8270D, 8280D	763187-6	15,89 €
	1,5 – 13	1/2"	6319D, 6339D, 6349D, 8414D, 8434D, 8444D	763188-4	35,09 €
	1,5 – 13	1/2"	DDF441, DDF451, DHP441, DHP451, DDF444, DDF454, DHP444, DHP454	763196-5	37,19 €
	1,5 – 10	3/8"	BDA341, BDA351, DF330D	763228-8	13,99 €
	0,8 – 10	1/2"	HP330	763229-6	8,79 €
	0,8 – 10	1/2"	HP332, DF332, HP333, DF333	763238-5	8,89 €
	1,5 – 13	1/2"	DDF483, DHP483	763241-6	20,69 €
	0,8 – 10		DDF343, DF347	763243-2	6,59 €
	1,5 – 13	1/2" – 20 UNF	DDF446, DDF456, DDF459, DDF480, DDF482, DDF484, DDF485	763252-1	24,59 €
	0,8 – 10		MT080, DF0300	766012-0	12,01 €
	1,5 – 13	1/2" – 20 UNF	DDF446, DDF456, DDF459, DDF480, DDF482, DDF484, DDF485	766027-7	15,09 €

			držiak klúča ku skľučovadlu	410102-8	0,19 €
--	--	--	-----------------------------	----------	--------

PRÍSLUŠENSTVO K VŔTAČKÁM

ø mm	L1 mm	L2 mm	ks/bal	Obj. č.	MOC s DPH
------	-------	-------	--------	---------	-----------

Príslušenstvo pre magnetickú vŕtačku HB350 / 500



12	30		1	12S	22,19 €
13	30		1	13S	22,49 €
14	30		1	14S	22,79 €
15	30		1	15S	23,09 €
16	30		1	16S	24,19 €
17	30		1	17S	25,79 €
18	30		1	18S	26,39 €
19	30		1	19S	26,89 €
20	30		1	20S	30,19 €
22	30		1	22S	32,09 €
24	30		1	24S	34,29 €
26	30		1	26S	39,79 €
28	30		1	28S	45,79 €
30	30		1	30S	48,29 €
32	30		1	32S	51,29 €
36	30		1	36S	60,79 €
38	30		1	38S	67,69 €
40	30		1	40S	78,09 €
46	30		1	46S	96,49 €
50	30		1	50S	105,19 €

strediaci vrták		1	PILOTS	7,99 €
strediaci vrták		1	PILOTU1A	6,99 €
strediaci vrták		1	PILOTU1B	8,69 €
skúčovadlo pre HB500		1	BD062	311,45 €

priemery od 36 do 50 len pre model HB500

Háčky pre aku vŕtacie skrutkovače

model	obj. č.	MOC s DPH
BDF444, DDF446, BDF454, DDF456, DDF458, BDF444, DDF446, BDF454, DDF456, DDF458, DDF459, DDF480, DDF481, BHP444, DHP446, BHP454, DHP456, DHP458, DHP459, DHP480, DHP481, DTW250, DTW251, DTW280	346317-0	2,39 €
DFR540RFE, DFR550RFE, DFR750RFE	281217-6	3,20 €
BTW450RFE	345736-7	2,08 €
DTD134, DTD137, DTD138, DTD148, DTD149, DTS130, DTS131, DTS141, DTW152, DTW190, DTW253, DTW284, DTW285, DTW300, DTW301	197942-8	cena na vyžiadanie

DDF441, DDF444, DDF448, DDF451, DDF454, DDF458, DDF481, DDF486, DF001G, DHP441, DHP444, DHP448, DHP451, DHP454, DHP458, DHP481, DHP486, HP001G	452947-8	0,32 €
--	----------	--------



Vykružovacie korunky do železa a nehrdzavejúcej ocele

ø mm	max. hrúbka materiálu (mm)	ks/bal	obj. č.	MOC s DPH
16	4	1	B-00898	58,89 €
20	4	1	B-00913	59,89 €
38	4	1	B-01018	93,99 €



Príslušenstvo pre miešadlá



Kruhové miešadlo vyrovnávacie hmoty, bitúmenové vrstvy, farby, základný adhézný náter, náterové tmely, zaliievacie hmoty

Špirálové miešadlo stavebné lepidlá, mazaninu, hotovú maltu, lepidlo na kachličky, škárovaciu hmotu, maltu na lepenie obkladov, omietky, náterové tmely, tepelné izolačné omietky

Zmiešané miešadlo vyrovnávacie hmoty, stavebné lepidlá, betón, mazaninu, hotovú maltu, maltu na lepenie obkladov, nivelačné hmoty, všetky druhy malty



Špirálové miešadlo „negatív“ M14 disperzie, farby, vápennosadrovú maltu, tepelnú izolačnú omietku. Zmiešaný účinok dole



Tanierová metla farba, nivelačné potery



ø mm	popis	L mm	upínanie	ks/bal	Obj. č.	MOC s DPH
------	-------	------	----------	--------	---------	-----------

80	kruhovú metla 10 – 15 kg	400	6 hran	1	P-02331	12,59 €
120	kruhovú metla 15 – 30 kg	590	M14	1	P-22012	22,19 €
120	kruhovú metla 10 – 15 kg	600	6 hran 3/8"		D-73536	10,19 €
120	kruhovú metla 15 – 30 kg	600	6 hran 3/8"		D-73542	9,69 €
90	špirálovú metla 7 – 10 kg	400	6 hran	1	P-02347	12,09 €
135	špirálovú metla 15 – 30 kg	590	M14	1	P-22040	30,19 €
100	zmiešanú metla 5 – 15 kg	590	6 hran	1	P-02353	32,19 €
120	špirálovú metla „negatív“ 15 – 25 kg	590	M14	1	P-22056	36,49 €
120	špirálovú metla 15 – 25 kg	600	M14	1	D-73514	18,69 €
120	špirálovú metla 15 – 25 kg	600	M14	1	D-73520	15,79 €
100	špirálovú metla 30 KG	600	M14	1	P-76766	26,09 €
165	tanierovú metla		M12	1	165757-1	8,59 €
130	tanierovú metla		M12	1	A-43670	14,09 €
	oska miešadla	560	M12	1	168349-5	25,69 €
	adaptér miešadla		1/2" – M12	1	323962-8	8,39 €
	adaptér miešadla		1/2" – M14	1	P-22062	9,09 €
	adaptér miešadla		5/8" – M14	1	P-02325	9,09 €
	ochranný kryt		DUT130	1	458814-5	cena na vyžiadanie
	bočná rukoväť		DUT130	1	140G50-6	cena na vyžiadanie

Akumulátory
Odkladacie systémy
Vŕtanie
Skrutkovanie
Brúsky
Pílenie
Frézovanie
Brúsenie
Klince / spony
Špeciálne stroje
Vysávanie
Fény/lampy
Záhrada
Ručné náradie
Ostatné

PRÍSLUŠENSTVO K VŔTAČKÁM

Diamantové vŕtacie korunky na vŕtanie nasucho – upínanie M16



Vhodné pre DBM080 a DBM130.



	ø mm	veľkosť (mm)	Obj. č.	MOC s DPH
diamantová vŕtacia korunka	76	150	P-42020	228,79 €
	82	400	P-42086	240,49 €
	112	400	P-42092	286,79 €
vystredovacia tyč	60		P-41888	32,69 €
	112		P-41969	5,99 €
	132		P-41981	17,39 €

Do vypredania skladových zásob.

Postup montáže vŕtacích korúnok

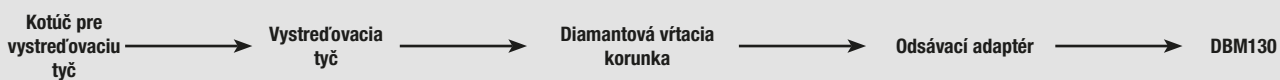

Diamantové korunky vŕtanie na sucho DB6 DIAMAK



Vhodné na rezanie:
Žula, mramor, vápenec, bridlica,
tvrdé tehly a iné husté
a neabrazívne materiály.

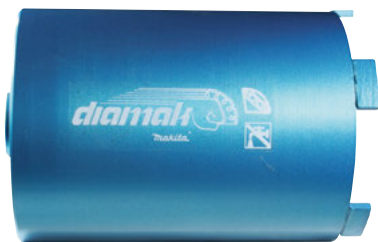

ø mm	dĺžka mm	ks/bal	Obj. č.	MOC s DPH
48	150	1	P-64107	cena na vyžiadanie
52	150	1	P-64113	54,09 €
68	150	1	P-64129-68	62,99 €
78	150	1	P-64135	62,19 €

popis	Obj. č.	MOC s DPH
adaptér 1/2" na HEX	P-34562	17,49 €
adaptér 1/2" na SDS-PLUS	P-30031	21,39 €
vyrážací klin	P-34752	4,99 €
vodiaca tyč pre korunky	P-34746	8,19 €

ø mm	H mm	Obj. č.	MOC s DPH
------	------	---------	-----------

Diamantové jadrové vŕtáky na vŕtanie namokro



DWC4CR

Vhodný na rezanie:
betónu, vystuženého betónu,
pieskovca, tehál.
Pre použitie s DBM230 nutné dokúpiť
adaptér P-41676.



18	300	P-40870	99,59 €
36	300	P-40973	124,39 €

Do vypredania skladových zásob.

PRÍSLUŠENSTVO K DIAMANTOVÝM VŔTAČKÁM

	dĺžka mm	Obj. č.	MOC s DPH
--	-------------	---------	-----------

Šesťhranná predĺžovacia tyč z ocele



5/4" UNC na 5/4" UNC

200	P-41610	44,59 €
300	P-41626	57,79 €
400	P-41632	66,09 €
500	P-41648	93,29 €



Prírubby pre vrtáky so „závitom“



kotviaca (zatĺkacia) hmoždinka (M12)	P-41741	5,09 €
--------------------------------------	---------	--------



Sada upevňovacích kotiev



sada kotiev	P-40098	37,89 €
-------------	---------	---------



Adaptéry



vonkajší 5/4" UNC na vonkajší 1/2" BSP	P-41676	56,29 €
vnútorný 1/2" BSP na vnútorný 5/4" UNC	P-41682	65,99 €
vnútorný 1/2" BSP na vnútorný 1/2" BSP	P-41698	41,79 €
hl na vonkajší 1/2" BSP	P-41707	52,09 €
vnútorný M18 na vonkajší 5/4" / vnútorný 1/2"	P-42151	36,69 €

P-41676

P-41682



P-41707

P-41698



P-42151



Stojan jadrovej vŕtačky DBM230/131



Stojan jadrovej vŕtačky DBM230	P-54190	1 523,79 €
Stojan jadrovej vŕtačky DBM131	P-40082	802,29 €









Do vypredania skladových zásob.

Akumulátory
Odkladacie systémy
Vŕtanie
Skrutkovanie
Brúsky
Pílenie
Frézovanie
Brúsenie
Klince / spony
Špeciálne stroje
Vysávanie
Fény/lampy
Záhrada
Ručné náradie
Ostatné

Príslušenstvo

Skrutkovanie, bity, držiaky, nástrčné kľúče

1. C-form 	
2. E-form 	
3. obojstranné 	
4. držiaky bitov 	
5. nástrčné kľúče 	
6. sady bitov 	
7. adaptéry 	
8. nástrčné kľúče pre rázové uťahovákы 	
9. iné produkty 	

Impact

PREMIER

*Double Torsion
for High Durability.*



*High Precision
Screw Fitting.*

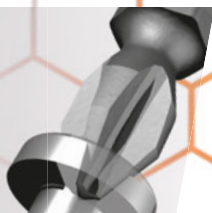

*New Steel
is Used.
Supports High Torque.*

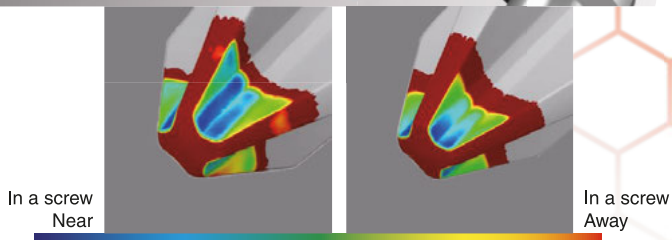

**Impact
PREMIER**

STANDARD

Torque

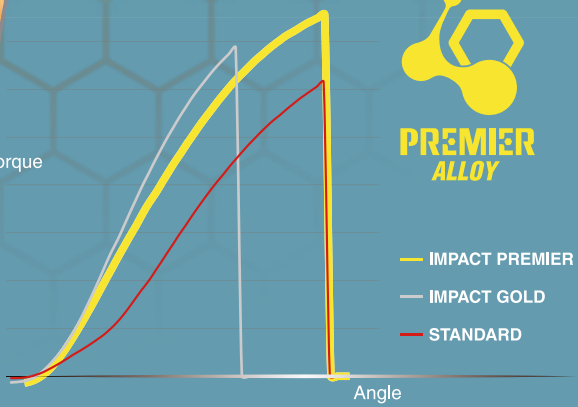

- IMPACT PREMIER
- IMPACT GOLD
- STANDARD

Angle

NEW INNOVATION



Premier



BT



BT



vložit sadu ku E-03567

E-13552

39,79 € (MOC s DPH)

PH1; 5 x PH2; 2 x PH3;
PZ1; 5 x PZ2; 2 x PZ3;
T10; T15; 3 x T20; 2 x T25;
2 x T30; H4; H5; H6; SL4; SL6;
magnetický držiak bitov 50 mm

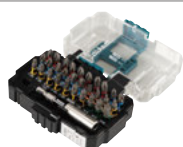

typ	dĺžka mm	ks/bal	Obj. č.	MOC s DPH
PH 1	25	2	E-03121	3,69 €
PH 2	25	2	E-03137	3,59 €
PH 2	25	15	E-03246	18,19 €
PH 2R	25	2	E-03143	3,79 €
PH 3	25	2	E-03159	3,69 €
PZ 1	25	2	E-03165	3,69 €
PZ 2	25	2	E-03171	3,69 €
PZ 2	25	15	E-03252	18,69 €
PZ 3	25	2	E-03187	3,69 €
T 10	25	2	E-03193	3,59 €
T 15	25	2	E-03202	3,59 €
T 20	25	2	E-03218	3,69 €
T 25	25	2	E-03224	3,69 €
T 30	25	2	E-03230	3,69 €

PH 1	50	2	E-03268	4,99 €
PH 2	50	2	E-03274	5,19 €
PH 2	50	10	E-03377	18,99 €
PH 3	50	2	E-03280	5,09 €
PZ 1	50	2	E-03296	5,09 €
PZ 2	50	2	E-03305	4,99 €
PZ 2	50	10	E-03383	18,99 €
PZ 3	50	2	E-03311	4,99 €
T 10	50	2	E-03327	5,09 €
T 15	50	2	E-03333	5,09 €
T 20	50	2	E-03349	4,99 €
T 25	50	2	E-03355	4,99 €
T 30	50	2	E-03361	5,09 €
T 40	50	2	E-12027	5,09 €

torzný držiak bitu magnetický	68	1	E-03399	6,89 €
torzný držiak bitu magnetický	150	1	E-03408	9,09 €

torzný držiak bitu ultra magnetický	79	1	E-03414	8,09 €
-------------------------------------	----	---	---------	--------

nástrčný kľúč 6	65	1	E-03458	4,29 €
nástrčný kľúč 8	65	1	E-03464	4,69 €
nástrčný kľúč 10	65	1	E-03470	4,79 €
nástrčný kľúč 13	65	1	E-03486	6,69 €

nástrčný kľúč kĺbový 13	80	1	E-03492	9,19 €
nástrčný kľúč kĺbový 17	80	1	E-03517	9,59 €
nástrčný kľúč kĺbový 19	80	1	E-03523	9,79 €

adaptér 1/4" – 1/2"	50	1	E-03436	7,49 €
adaptér 1/4" – 3/8"	50	1	E-03420	7,09 €

PH1, PH2, PH3, PZ1, PZ2, PZ3, T15, T20, T25, T30 x 25 mm, Magnetický držiak bitov 50 mm	1	E-03567	22,89 €
PH2, PZ1, PZ2, PZ3, T15, T20, T25, T30, SL4, SL6 x 25 mm, Magnetický držiak bitov 50 mm	1	E-03573	22,99 €

magnetický držiak	1	E-03442	3,29 €
-------------------	---	---------	--------

typ	dĺžka mm	ks/bal	Obj. č.	MOC s DPH
-----	----------	--------	---------	-----------

Impact black



PH 1	25	2	B-63600	1,69 €
PH 2	25	2	B-63616	1,99 €
PH 3	25	2	B-63622	1,79 €
PZ 1	25	2	B-63638	1,79 €
PZ 2	25	2	B-63644	1,89 €
PZ 3	25	2	B-63650	1,69 €
T 15	25	2	B-63666	1,89 €
T 20	25	2	B-63672	1,89 €
T 25	25	2	B-63688	1,99 €
T 30	25	2	B-63694	1,79 €
T 40	25	2	B-63703	1,79 €
torzný držiak bitu magnetický	60	1	B-66793	3,99 €
torzný držiak bitov magnetický	80	1	B-66818	4,19 €
torzný držiak bitov magnetický s poistkou	60	1	B-66802	5,09 €
adaptér 1/4" – 1/2"	50	1	B-66874	2,99 €
adaptér 1/4" – 3/8"	50	1	B-66868	2,49 €
PH 1	50	2	B-63719	2,59 €
PH 2	50	2	B-63725	2,89 €
PH 3	50	2	B-63731	2,49 €
PZ 1	50	2	B-63747	2,59 €
PZ 2	50	2	B-63753	2,69 €
PZ 3	50	2	B-63769	2,49 €
T 15	50	2	B-63775	2,69 €
T 20	50	2	B-63781	2,69 €
T 25	50	2	B-63797	2,79 €
T 30	50	2	B-63806	2,59 €
T 40	50	2	B-63812	2,79 €
PZ2	50	10	E-12413	10,19 €
T20	50	10	E-12429	10,09 €
T25	50	10	E-12435	10,09 €
T30	50	10	E-12675	10,19 €
T40	50	10	E-12681	10,29 €
nástrčný kľúč 6	50	1	B-66824	2,29 €
nástrčný kľúč 8	50	1	B-66830	2,69 €
nástrčný kľúč 10	50	1	B-66846	2,49 €
nástrčný kľúč 13	50	1	B-66852	2,79 €

IMPACT BLACK SADA BITOV 8 KS **E-11994** **9,19 €** (MOC s DPH)

PH1; 2 X PH2; PH3;
PZ1; PZ2; PZ3,
magnetický držiak bitu 60 mm

IMPACT BLACK SADA BITOV 10 KS **E-12011** **15,39 €** (MOC s DPH)

PH1; PH2; PH3.
PZ1; PZ2; PZ3;
T15; T20; T25; T30;

IMPACT BLACK SADA BITOV 33 ks **B-66896** **45,19 €** (MOC s DPH)

PH1, 3 x PH2, PH3, PZ1,
3 x PZ2, PZ3 x 25 mm
T15, 2 x T20, 2 x T25, T30 x 25 mm
PH2, PZ2, T15, T20, T25, T30 x 50 mm
6/8/10 „orech“
dĺžka 60 mm – držiak bitu 1/4" magnet
dĺžka 80 mm – držiak bitu 1/4" magnet
vrták HSS-G – 2,5 / 3 / 3,5 / 4 / 4,5 / 5 mm

IMPACT BLACK SADA BITOV 35 ks **B-66880** **48,49 €** (MOC s DPH)

PH1, 3 x PH2, PH3, PZ1, 3 x PZ2,
PZ3 x 25 mm
T15, 2 x T20, 2 x T25, T30 x 25 mm
PH1, 2 x PH2, PH3, PZ1, 2 x PZ2,
PZ3 x 50 mm
T15, T20, 2 x T25, T30 x 50 mm
SLO 8 x 5,5 x 50 mm
magnetický držiak bitov 60 mm
6/8/10/13 x 50 mm „orech“

Sada nástrčných kľúčov 6 ks **E-15768** **20,79 €** (MOC s DPH)

Nástrčné magnetické kľúče
6; 7; 8; 10; 12; 13 x 50 mm

Sada bitov 10 ks **E-12005** **13,59 €** (MOC s DPH)

Bity 25 mm: PH1; PH2; PH3;
PZ1; PZ2; PZ3; T15; T20; T30
magnetický držiak bitov 60 mm

Akumulátory
Odkladacie systémy
Vrtanie
Skrutkovanie
Brúsky
Pílenie
Frézovanie
Brúsenie
Klince / spony
Špeciálne stroje
Vysávanie
Fény/lampy
Záhrada
Ručné náradie
Ostatné

SKRUTKOVÁČE

typ	dĺžka mm	ks/bal	Obj. č.	MOC s DPH
-----	----------	--------	---------	-----------

Skrutkovacie hroty Krížové „PH“

STANDARD	PH1	25	5	P-47933	3,69 €
	PH1	50	5	P-48402	4,69 €
	PH2	25	5	P-47949	3,49 €
	PH2	50	5	P-48418	4,69 €
	PH3	25	5	P-47955	3,49 €
	PH3	50	5	P-48424	4,49 €

PROFI	PH1	25	5	P-47874	3,79 €
	PH1	50	5	P-48234	12,39 €
	PH1	89	5	P-48240	17,09 €
	PH2	25	5	P-47880	3,99 €
	PH2	25	50	P-47880-50	20,69 €
	PH2	25	100	P-47880-100	38,99 €
	PH2	50	5	P-48256	12,39 €
	PH2	89	5	P-48262	17,59 €
	PH2	127	5	P-48278	18,69 €
	PH2	141	5	P-48315	20,99 €
	PH3	25	5	P-47896	3,79 €

TITAN	PH2	25	5	P-48000	7,09 €
	PH2	50	5	P-48474	8,09 €

Skrutkovacie hroty Krížové „PZ“

STANDARD	PZ1	25	5	P-47961	3,69 €
	PZ1	50	5	P-48430	4,69 €
	PZ2	25	5	P-47977	3,69 €
	PZ2	25	50	P-47977-50	16,19 €
	PZ2	25	100	P-47977-100	31,19 €
	PZ2	50	5	P-48446	4,69 €
	PZ3	25	5	P-47983	3,69 €
	PZ3	50	5	P-48452	4,49 €

PROFI	PZ1	25	5	P-47905	3,79 €
	PZ1	50	5	P-48321	11,99 €
	PZ1	89	5	P-48337	17,99 €
	PZ2	25	5	P-47911	3,79 €
	PZ2	25	50	P-47911-50	20,59 €
	PZ2	25	100	P-47911-100	41,29 €
	PZ2	50	5	P-48343	12,39 €
	PZ2	89	5	P-48359	17,99 €
	PZ2	127	5	P-48365	19,39 €
	PZ3	25	5	P-47927	3,79 €
	PZ3	50	5	P-48371	11,69 €

TITAN	PZ1	25	5	P-48022	7,19 €
	PZ2	25	5	P-48038	7,19 €
	PZ2	50	5	P-48505	8,89 €
	PZ3	25	5	P-48044	7,99 €
	PZ3	50	5	P-48511	8,59 €

typ	dĺžka mm	ks/bal	Obj. č.	MOC s DPH
-----	----------	--------	---------	-----------

Skrutkovacie hroty TORX

PROFI	T8	25	5	P-48050	5,39 €
	T8	50	5	P-48527	6,09 €
	T9	25	5	P-48066	5,39 €
	T9	50	5	P-48533	5,89 €
	T10	25	5	P-48072	5,49 €
	T10	50	5	P-48549	5,99 €
	T15	25	5	P-48088	5,79 €
	T15	50	5	P-48555	6,09 €
	T20	25	5	P-48094	5,59 €
	T20	50	5	P-48561	5,99 €
	T25	25	5	P-48103	5,59 €
	T25	50	5	P-48577	5,99 €
	T27	25	5	P-48119	5,39 €
	T27	50	5	P-48583	5,69 €
	T30	25	5	P-48125	5,59 €
	T30	50	5	P-48599	5,99 €
	T40	25	5	P-48131	5,79 €
	T40	50	5	P-48608	5,99 €

TITAN	T10	25	5	P-48169	8,69 €
	T10	50	5	P-48636	8,99 €
	T15	50	5	P-48642	8,99 €
	T20	25	5	P-48181	9,09 €
	T20	50	5	P-48658	9,69 €
	T25	25	5	P-48197	9,19 €
	T25	50	5	P-48664	9,09 €
	T27	50	5	P-48670	9,29 €
	T30	25	5	P-48212	8,99 €
	T40	25	5	P-48228	8,99 €

Nástrčkový bit

PROFI	5,5	50	1	P-48723	5,69 €
	6	50	1	P-48739	5,89 €
	7	50	1	P-48745	6,49 €
	8	50	1	P-48751	6,69 €
	9	50	1	P-48767	6,49 €
	10	50	1	P-48773	7,49 €
	10	65	1	P-48789	8,19 €
	13	50	1	P-48795	8,39 €
	13	65	1	P-48804	9,19 €
	17	50	1	P-48810	10,59 €
	17	65	1	P-48826	11,49 €

Nástrčkový bit s magnetom

PROFI	7	50	1	P-48854	11,39 €
	8	50	1	P-48860	11,19 €
	10	50	1	P-48876	11,79 €
	10	65	1	P-48882	12,69 €
	13	50	1	P-48898	12,89 €
	6, 8, 10, 12, 13	50	1	B-39154	7,39 €



SKRUTKOVAČE

typ	dĺžka mm	ks/bal	Obj. č.	MOC s DPH
Magnetický nadstavec *****				
magnetický nadstavec	60	1	P-49018	6,99 €
magnetický nadstavec	60	1	B-52445	3,89 €
magnetický nadstavec	75	1	P-49024	8,69 €
magnetický nadstavec	80	1	B-48751	3,39 €
magnetický nadstavec	150	1	B-57750	5,09 €
magnetický nadstavec	300	1	B-57766	8,59 €

Obojstranné magnetické bity *****				
PZ2	65	100	D-34914	47,89 €
PH2	65	100	D-31669	56,19 €

Ohybný hriadel' so skrutkovacou čepeľou *****				
	200	1	B-29072	6,59 €
	300	1	B-29094	8,19 €

typ	dĺžka mm	ks/bal	Obj. č.	MOC s DPH
Adaptér *****				
adaptér 1/4" – 3/8"	50	1	B-54667	1,99 €
adaptér 1/4" – 1/2"	50	1	B-54673	2,99 €

Nadstavec na sádkartonárske skrutky PH2 *****				
upínanie 1/4"	30	1	D-61690	1,39 €

Nadstavec na zakrúcanie závitových tyčí s upínaním 1/4" *****				
M8	66	1	B-42977	19,79 €

Obojstranné magnetické bity *****				
PH2	85	3	B-12326	10,19 €
PZ2	85	3	B-12790	11,19 €

Sada bitov 61 ks **P-70144** **59,09 €** (MOC s DPH)

2x5,5 / 2x6,5; 6xPH1; 12xPH2; 4xPH3; 2xPZ0; 6xPZ1; 12xPZ2; 2xPZ3; 2xT10, T15, T20; 2xT25, T30, T40;



Sada bitov 26 ks **B-48773** **13,09 €** (MOC s DPH)

5 x PH2 25 mm; 5 x PZ2 25 mm; 5 x T20 25 mm; 5 x T25 25 mm; 5 x T30 25 mm; x 80 mm magnetický držiak bitov



Sada bitov 11 ks **P-49030** **11,79 €** (MOC s DPH)

1ks SL3,5; 1ks SL5,5; 1ks PH1; 2ks PH2; 1ks PH3; 1ks PZ1; 2ks PZ2; 1ks PZ3; 1ks magnetický nadstavec



Sada bitov 31 ks **P-73374** **20,19 €** (MOC s DPH)

2ks PH1; 4ks PH2; 2ks PH3; 2ks PZ1; 4ks PZ2; 2ks PZ3; 1ks T8; 2ks T10; 2ks T15; 2ks T20; 3ks T25; 1ks T27; 2ks T30; 1ks T40; 1ks nadstavec



Sada bitov 11 ks **P-49046** **19,19 €** (MOC s DPH)

1ks SL3,5; 1ks SL5,5; 1ks PH1; 2ks PH2; 1ks PH3; 1ks PZ1; 2ks PZ2; 1ks PZ3; 1ks magnetický nadstavec



Sada bitov 21 ks **B-68323** **17,49 €** (MOC s DPH)

PH1; 2ks PH2; PH3 x 50 mm; PZ1; 2ks PZ2; PZ3; T10; T15; T20; x 50mm; T10; T15; T20; 2ks T25; 2ks T30; x 50 mm; H3; H4; H5; H6 x 50 mm; SL5,5; SL6,5 x 50 mm



Sada bitov 30 ks **E-15774** **28,39 €** (MOC s DPH)

Bity 25 mm: PZ0; PZ1; PZ2; PZ3; PH0; PH1; PH2; PH3; SL3; SL4; SL5; SL6; H3; H4; H5; H6; Bity 50 mm: SL3; SL5; PZ1; PZ2 x 2; PH1; PH2; Bity 75 mm: SL3; SL4; PZ1; PZ2; PH1; PH2; 1 x magnetický držiak bitov 60 mm



SKRUTKOVÁČE

Sada bitov 31 ks, balenie 12 ks **D-30667-12** **148,79 €** (MOC s DPH)

plochý 4 (1 ks); plochý 5,5 (1 ks); plochý 6,5 (1 ks); PH1 (2 ks); PH2 (4 ks); PH3 (1 ks); PZ1 (2 ks); PZ2 (5 ks); PZ3(1 ks); T10 (2 ks); T15 (2 ks); T20 (2 ks); T25 (3 ks); T30 (2 ks); T40 (1 ks)



Sada bitov 11 ks, balenie 12 ks **D-30651-12** **117,79 €** (MOC s DPH)

PH1, PH2, PH3 × 25 mm
PZ1, PZ2, PZ3, × 25 mm
T15, T20, T25, T30 × 25 mm
magnetický nastavtec 50 MM



Sada bitov 12 ks, balenie 12 ks **D-31083-12** **101,19 €** (MOC s DPH)

plochý 4 (1 ks); plochý 5,5 (1 ks); plochý 6,5 (1 ks); PH1 (2 ks); PH2 (4 ks); PH3 (1 ks); PZ1 (2 ks); PZ2 (5 ks); PZ3(1 ks); T10 (2 ks); T15 (2 ks); T20 (2 ks); T25 (3 ks); T30 (2 ks); T40 (1 ks)



Sada bitov 31 ks, balenie 12 ks **E-00022** **181,39 €** (MOC s DPH)

PH0, PH1, 4 × PH2, PH3 × 25 mm
PZ0, PZ1, 4 × PZ2, PZ3 × 25 mm
T10, T15, T20, T27, T30, T40 × 25 mm
H3, H4, H5, H6 × 25 mm
SL4,5, SL5,5, SL6,5 × 25 mm



Sada bitov 31 ks, balenie 12 ks **E-03090** **270,69 €** (MOC s DPH)

2 × PH1, 5 × PH2, 2 × PH3 × 25 mm
2 × PZ1, 5 × PZ2, 2 × PZ3 × 25 mm
3 × T15, 3 × T20, 3 × T25,
3 × T30 × 25 mm
držák bitov magnetický 60 mm



Sada bitov a vrtákov 31 ks **B-49389** **33,59 €** (MOC s DPH)

vrtáky do železa ø 2; 2 × 3; 3,3; 4; 4,2; 5;
vrtáky do tehly a muriva ø 4; 5; 6; 7; 8;
vrtáky do dreva ø 3; 4; 5; 6; 7; 8;
nástrčné kľúče ø 6; 8; 10;
PH1; PH2; PH3; PZ1; PZ2; PZ3; SL6;
SL8; T20; T25;
držák bitov
záhlbníkový vrták



Sada bitov a vrtákov 60 ks **E-11829** **32,99 €** (MOC s DPH)

bity 25 mm: PZ0 1 ks; PZ1 2 ks;
PZ2 6 ks; PZ3 2 ks; PH1 1 ks;
PH2 1 ks; PH3 1 ks; T15 1 ks;
T20 1 ks; HEX3 1 ks; HEX4 1 ks;
HEX5 1 ks; HEX6 1 ks; SL0,5 x 3 1 ks;
SL0,8 x 4 3 ks; SL0,8 x 5 1 ks;
SL1 x 5,5 2 ks; SL1 x 6 1 ks;
SL1,2 x 6,5 3 ks; SL1,2 x 7 1 ks;
bit s dorazom 1 ks; magnetický držák
bitov 60 mm 1ks; záhlbník 36 1 ks;
Nástrčné kľúče: 5; 6; 7; 8; 9; 10;
11 x 38 mm
Vrták do dreva s valcovitou stopkou
Ø mm: 3; 4; 5; 6; 7; 8;
Vrták do kovu HSS-TiN Ø mm: 2;
3 2 ks; 3,2; 4; 4,5; 5;
Vrták do muriva s valcovitou stopkou
Ø mm: 5; 5,5; 6; 7; 8;



Sada bitov a vrtákov 102 ks **B-68432** **57,59 €** (MOC s DPH)

PH1; PH2; PH3; PZ1; PZ2; PZ3;
H3; H4; H5; H6; H7;
SL3; SL4; SL6; SL7; SL8;
T10; T15; T20; T25; T30;
držák bitov magnetický 60 mm
vrtáky do železa, muriva, dreva
nástrčné kľúče,
záhlbníkový vrták



Sada bitov 32 ks, balenie 12 ks **D-74762-12** **167,69 €** (MOC s DPH)





PH1(2 ks); PH2(4 ks);PH3; PZ1(2 ks);
PZ2(5 ks)
T10(2 ks); T15(2 ks); T20(2 ks); T25(3 ks)
T30(2 ks); T40; LS4; SL5,5; SL6,5;
Magnetický nastavtec s poisťou 60 mm
Adaptér šesťhran na štvorhran



Sada bitov a vrtákov 71 ks **D-33691** **92,69 €** (MOC s DPH)

vrták HSS TiN 1,5; 2; 2,5; 3; 3,5; 4;
4,5; 5; 5,5; 6; 6,5; 7
vrták do dreva 4; 5; 6; 8; 10
vrták do kameňa 3; 4; 6; 8
vrták plochý do dreva 8; 15; 20
nástrčný kľúč 8; 10; 12; 13
zalomovací nôž, meter 3 m
2 × PH1, 2 × PH2, 2 × PH3 × 25 mm
2 × PZ1, 2 × PZ2, 2 × PZ3 × 25 mm
T20, T25, T30, T40 × 25 mm
SL1, SL1,2, SL1,6, H3, H4, H5,
H6 × 25 mm
2 × magnetický držák bitov 50 mm
10 × bit 50 mm



<p>Sada bitov 30 ks</p> <p>Bity 50 mm: PH1; PH2 x 2 ks; PH3; PZ2; SL5,5; T25; T30 Bity 25 mm: PH1; PH2 x 2 ks; PH3; PZ1; PZ2; PZ3; T20 T25; T30; H3; H4; H5; H6; SL5,5; SL6,5; Nástrčný kľúč magnetický 48 mm: 8; 10; 12 Nástrčný kľúč upínanie 3/8": 17; 19; Adaptér 1/4" na 3/8" x 50 mm Magnetický držiak bitov 60 mm</p>	<p>E-07060 38,69 € (MOC s DPH)</p> 	<p>Sada bitov 32 ks</p> <p>Bity 75 mm: PH1; PH2; PZ1; PZ2; SL5,5; T30; SL5,5; SL6,5; Bity 25 mm: PH0; PH1; PH2 x 3 ks; PH3; PZ0; PZ1; PZ2 x 2 ks; PZ3; H3; H4; H5; H6; T10; T15; T20; T25; T30; H3; H4; H5; H6; SL0.5 x 3; SL0.8 x 5.5; SL1.2x6.5 Magnetický držiak bitov 60 mm</p>	<p>E-07076 22,59 € (MOC s DPH)</p> 
<p>Sada bitov a vrtákov 18 ks</p> <p>Bity 50 mm: PH1; PH2 x 2 ks; PZ1; PZ2; PZ3; SL5,5; T30; SL0.8 x 5.5; SL1.2 x 6.5; Nástrčný kľúč magnetický 48 mm: 6; 8; 10; 12 Vrták do betónu SDS-PLUS 160 mm: Ø 5; 6 x 2 ks; 8; 10; Magnetický držiak bitov Quick systém 80 mm</p>	<p>E-07026 26,69 € (MOC s DPH)</p> 	<p>Sada bitov a vrtákov 29 ks</p> <p>Bity 25 mm: PH1; PH2; PZ0; PZ1; PZ2; PZ3; H3; H4; H5; H6; T10; T15; T20; T25; H3; H4; H5; H6; SL0.5 x 3; SL0.8 x 5; SL1 x 6 Magnetický držiak bitov Quick systém 80 mm Vrtáky do kovu HSS-Tin Ø : 3; 4; 5; 6; 8 Vrtáky do betónu Ø: 4; 5; 6; 8; Vrtáky do dreva: Ø: 5; 6; 8;</p>	<p>E-07054 33,09 € (MOC s DPH)</p> 
<p>Gola sada 212 ks</p> <p>račňa 1/2"; 1/4"; križový kľúč 1/4" predĺženie 1/4" 50; 100 mm; 1/2" 50; 100 mm adaptér 1/2" na 3/8" kĺbový adaptér 1/4" na 1/4"; 1/2" na 1/2" kľúč na sviečky 1/2" 16; 21 x 65 mm orech šesťhran 1/4": 4; 4,5; 5; 5,5; 6; 7; 8; 9; 10; 11; 12; 13; 14 x 25 mm orech šesťhran 1/2": 15; 16; 17; 19; 20; 21; 22; 24 x 38 mm; 27 x 40 mm; 30; 32 x 44 mm orech hviezda 1/2": E10; E12; E14; E16; E18; E20; E24 x 38 mm kľúč nástrčný 1/4": 5; 5,5; 6; 7; 8 x 2; 9; 10 x 2; 11; 12; 13 x 38 mm kľúč očko/vidlica: 8; 10; 11; 12; 13; 14; 15; 16; 17; 18; 19 sada imbusov do ruky: 1,5; 2; 2,5; 3; 4; 5; 6; 8 rukoväť skrutkovača 1/4" samec; 1/4" samica bity 1/4" x 37 mm SL4; SL5; SL6; PH1; PH2; PH3; PZ1; PZ2; PZ3; T10; T15; T20; T25; T27; T30; T40; HEX3; HEX4; HEX5; HEX6 adaptér bitu 1/4" na 1/4" x 25 mm; 1/2" na 5/16" x 38 mm predĺžovací adaptér 1/4" 80 mm magnetický adaptér 1/4" 60 mm bity 25 mm PH0 5ks; PH1 5ks; PH2 20ks, PH3 5ks, PH4; T8 2ks; T9 2ks; T10 2ks; T15 2ks; T20 2ks; T25; T27; T30; T40; T9H; T10H; T15H; T20H; T25H; T27H; T30H 2ks; T40H; PZ0 2 ks; PZ1 2ks; PZ2 3ks; PZ3 2 ks; PZ4; SL3 2 ks; SL4 2 ks; SL5 2 KS; SL5,5 2ks; SL6,5 2 KS; H3; H4; H5; H6; H7; H8; H3H; H4H; H5H; H6H bity 30 mm PH3; PH4; PZ3; PZ4; T25; T27; T30; T35; T40; T45; T50; H4; H5; H6; H7; H8; SL6; SL7; SL8; T25H; T27H; T30H; T35H; T40H; T45H; T50H; M5; M6; M8; M10</p>		<p>E-10883 221,49 € (MOC s DPH)</p> 	



Sada bitov a vrtákov 34 ks **D-36980** **33,29 €** (MOC s DPH)

vrták HSS 2; 2,5; 3; 3,5; 4; 4,5; 5;
vrták do dreva 4; 5; 6; 7; 8
vrták do kameňa 4; 5; 6; 7; 8
nástrčný kľúč 7; 8; 10;
záhlbníkový vrták
držák bitov magnetický 50 mm
PH1, PH2, PH3, PH4, PZ1, PZ2, PZ3,
PZ4
T20, T25, T30, SL1, SL1,2, SL1,6

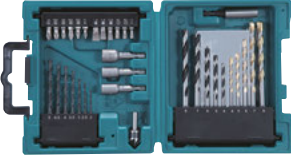

Sada bitov a vrtákov 102 ks **E-10730** **59,09 €** (MOC s DPH)

25 mm bity PZ1, PZ2, PZ3, PH1, PH2, PH3,
SL3, SL4, SL4,5, SL6, SL7, SL8
T10, T15, T20, T25, T27, T30
H3, H4, H5, H6, H7
50 mm bity PZ0, PZ1, PZ2, PZ3,
PH1, PH2, PH3
T10, T20, T25, T27,
H3, H4, H5, H6, SL3, SL4, SL 4,5
záhlbníkový vrták
držák bitov magnetický 60 mm
nástrčný kľúč 5; 5,5; 6; 7; 8; 9; 10; 11;
12; 13
doraz 3; 5; 8; 10; imbus kľúč 2,5 mm
priebojník
vrták do dreva ø 3; 4; 5; 5,5; 6; 6,5;
vrták HSS TiN ø 3; 4; 5; 5,5; 6; 6,5;
vrták do muriva ø 3; 4; 5; 5,5; 6; 6,5;
vrták do dreva plochý ø 12; 16; 19
korunka BiMetal ø 32; 38; 45; 54;
adaptér korunky
rukoväť skrutkovača
vodováha, meter, šablóna s priemermi



Sada bitov a vrtákov v systainery 69 ks **B-49638** **115,69 €** (MOC s DPH)

25 mm bity PH0; PH1; PH2; PH3;
PZ0; PZ1; PZ2; PZ3
T10; T15; T20; T25; T30; T40;
T10H; T15H; T20H; T25H; T27H;
T30H; T40H;
SL4; SL4,5; SL5,5; SL6,5; H3; H4; H5;
H6;
50 mm bity PH2; PZ2;
nástrčný kľúč 6; 8; 10; 12; 13;
vrták HSS-G ø 3; 4; 5; 6; 8;
vrták do dreva ø 3; 4; 5; 6; 8;
vrták do muriva ø 5; 6; 8; 10
vrták do dreva plochý ø 16; 20;



Sada bitov a vrtákov 212 ks **E-06270** **111,09 €** (MOC s DPH)

25 mm bity PH0; PH1; PH2; PH3;
PH4; PZ0; PZ1; PZ2; PZ3
SL3; SL4; SL5; SL5,5; SL6; SL7; SL8;
H3; H4; H5; H6; H7; H8;
T10; T15; T20; T25; T27; T30; T35;
T40; T45; SQ1; SQ2; SQ3; SQ4;
50 mm bity PH0; PH1; PH2; PH3;
PZ0; PZ1; PZ2; PZ3
SL3; SL4; SL5; SL6; SL7; SL8; H3;
H4; H5; H6; H7; H8;
T10; T15; T20; T25; T27; T30; T35;
T40; T45;
nástrčný kľúč 5; 5,5; 6; 7; 8; 9; 10; 11;
12; 13;
5/35; 3/16; 7/32; 1/4; 9/32; 5/16;
11/32; 3/8; 7/16; 1/2;
záhlbníkový vrták
držák bitov magnetický 60 mm
doraz 3; 5; 8; 10; imbus kľúč 2,5 mm
korunka BiMetal ø 32; 38; 45; 54;
adaptér korunky
vodováha, meter 3M, šablóna
s priemermi; ohybný hriadeľ
rukoväť skrutkovača; rukoväť v tvare
„T“; priebojník; tužka Makita;
vrták HSS ø 1; 1,5; 2; 2,5; 3; 3,2; 3,5;
4; 4,5; 5; 5,5; 6; 6,5; 7; 7,5; 8; 9; 10;
vrták do muriva ø 3; 4; 4,5; 5; 5,5; 6;
6,5; 7; 8; 9; 10
vrták do dreva ø 3; 4; 5; 6; 7; 8; 9; 10;
vrták do dreva plochý ø 12; 16; 18;
20; 22; 25;





Sada bitov a vrtákov 200 ks **D-37194** **175,59 €** (MOC s DPH)

25 mm bity PH0; PH1; PH2; PH3;
PZ0; PZ1; PZ2; PZ3
T10; T15; T20; T25; T30; T35; T40;
SL3; SL4; SL5; SL6; SL8; H3; H4; H5;
H6; H8;
50 mm bity PH0; PH1; PH2; PH3;
PZ0; PZ1; PZ2; PZ3
T10; T15; T20; T25; T30; T35; T40;
nástrčný kľúč 5; 5,5; 6; 7; 8; 9; 10; 11;
12; 13;
orech: 5, 6, 7, 8, 9, 10, 11, 13
korunka BiMetal ø 32; 38; 45; 54; 68;
vrták HSS ø 1; 1,5; 2; 2,5; 3; 3,2; 3,5;
4; 4,5; 5; 5,5; 6; 6,5; 7; 7,5; 8; 10;
vrták do dreva ø 3; 4; 5; 6; 7; 8; 10;
vrták do dreva plochý ø 8; 15; 20;
vrták do muriva ø 3; 4; 5; 6; 7; 8; 10
vodováha, meter 3M, šablóna
s priemermi; ohybný hriadeľ
rýchlopínací držák bitu 50 mm;
nastavovací kľúč
skrutkovač na bity; kliešte,
odstrihávacie kliešte;
baterka LED; orezávací nôž;
záhlbníkový vrták



SKRUTKOVÁČE: PROFESIONÁLNE BITY

	typ	dĺžka mm	ks/bal	Obj. č.	MOC s DPH
Profesionálne bity pre skrutkovače *****					
	PH2	25	10	P-06052	9,39 €
	PZ2	25	10	P-06111	9,39 €
	T40	25	10	P-06389	14,49 €

	typ	dĺžka mm	ks/bal	Obj. č.	MOC s DPH
Bit pre skrutkovače so zásobníkom 6842, 6843, DFR540, DFR550 *****					
	PH2	157	3	P-67795	19,89 €

Predĺženie rukoväti pre modely **194500-1** **85,29 €** (MOC s DPH)

6840 / 6841 / 6841R/ 6842 / 6843
6844 / 6845/ DFR440/540/550/750
predĺženie 56 – 66 cm



Automatický podávač skrutiek **191L24-0** **115,29 €** (MOC s DPH)

pre skrutky v pásoch
dĺžky 25 – 55 mm
kompatibilný s modelmi:
DFS452, DFS250, FS6300,
FS4300, FS4000, FS2300.
dodávaný s 2 x 130 mm PH2



Typ	model	ø (mm)	povrchová úprava	dĺžka mm	ks na páse	bal/ks	Automatický podávač 25 – 55 mm	Obj. č.	MOC s DPH
Skrutky do sadrokartónu upevneného do kovovej konštrukcie *****									
PH2	DFR540/DFR550/6842/6843/6845	3,9	fosfátované	25	50	1000	áno	F-30913	35,19 €
PH2	DFR540/DFR550/6842/6843/6845	3,9	fosfátované	30	50	1000	áno	F-30926	19,79 €
PH2	DFR540/DFR550/6842/6843/6845	3,9	fosfátované	35	50	1000	áno	F-31153	31,49 €
PH2	DFR540/DFR750/6842/6843/6845	3,9	fosfátované	45	50	1000	áno	F-30939	24,79 €
PH2	DFR540/DFR55/DFR750/6842/6843/6845	3,9	fosfátované	55	50	1000	áno	F-30942	29,39 €

Skrutky do sadrokartónu upevneného do dreva *****									
PH2	DFR540/DFR550/6842/6843/6845	3,9	fosfátované	35	50	1000	áno	F-31179	20,49 €
PH2	DFR540/DFR550/6842/6843/6845	3,9	fosfátované	41	50	1000	áno	F-31182	23,19 €
PH2	DFR540/6842/6843/6844	3,9	fosfátované	55	50	1000	áno	F-31140	27,89 €

Skrutky pre dosky typu Fermacell upevnené do kovovej konštrukcie *****									
PH2	DFR550	3,5	fosfátované	35	50	1000	áno	F-31195	35,39 €
PH2	DFR540/DFR550/6842/6843/6845	3,9	fosfátované	30	50	1000	áno	F-31748	cena na vyziadanie

Stavebné skrutky do dreva *****									
PH2	DFR540/DFR550/6842/6843/6845	4,2	pozinkované	40	50	1000	áno	F-31201	27,79 €
PH2	DFR540/DFR550/DFR750/6842/6843	4,2	pozinkované	55	50	1000	áno	F-31214	36,89 €

Stavebné rýchloskrutky pre trieskové a OSB dosky *****									
PH2	DFR540/DFR550/6842/6843/6845	4,0	biely zinok	35	50	1000	áno	F-31777	21,39 €
PH2	DFR540/DFR550/6842/6843/6845	4,0	biely zinok	40	50	1000	áno	F-31780	27,99 €
PH2	DFR750	4,5	biely zinok	75	50	500	nie	P-13225	72,69 €

Akumulátory
Odkladacie systémy
Vrtanie
Skrutkovanie
Brúsky
Pílenie
Frézovanie
Brúsenie
Klince / spony
Špeciálne stroje
Vysávanie
Fény/lampy
Záhrada
Ručné náradie
Ostatné

POUŽITIE SKRUTKOVÁČOV

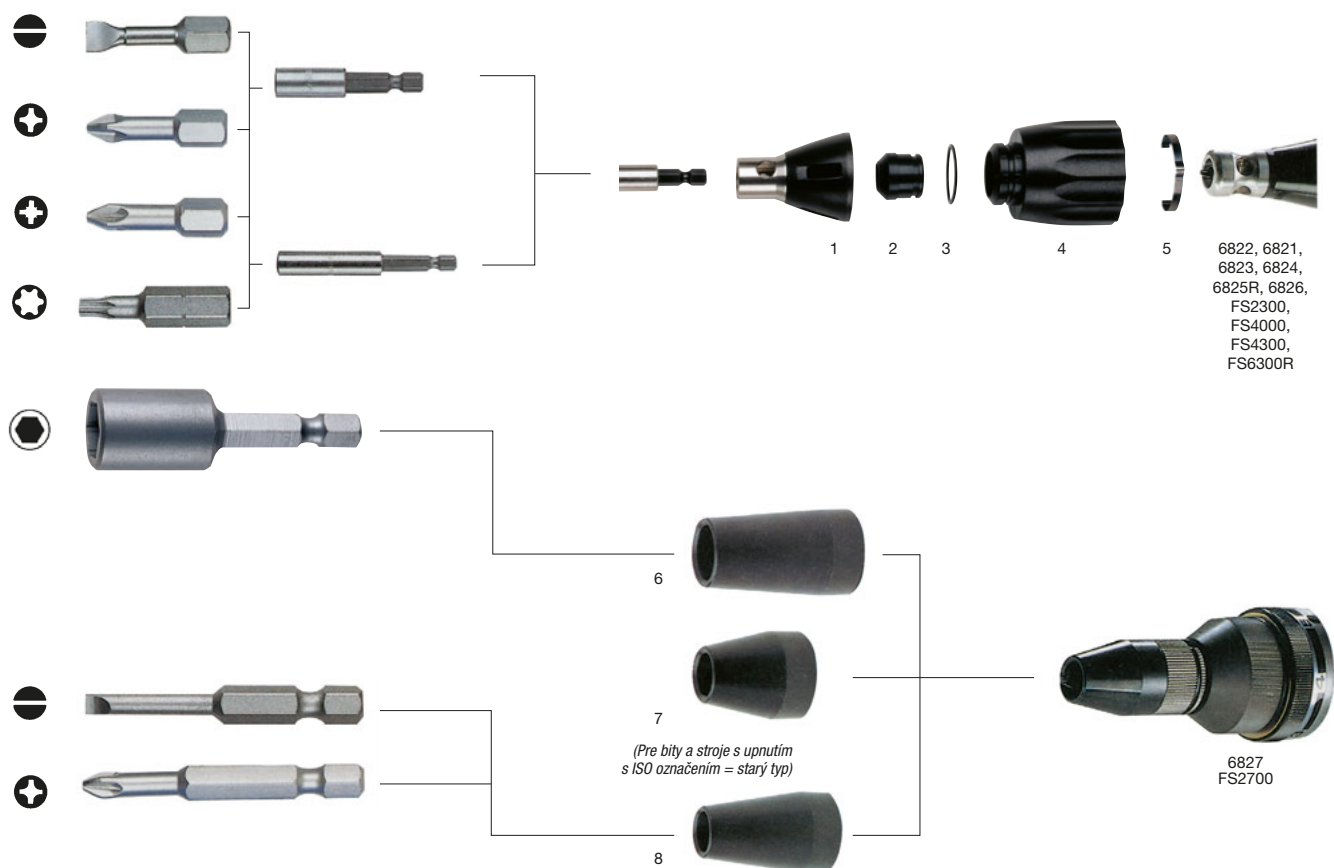

obr. č.	Popis	ø	ks/bal.	model	Obj. č.	MOC s DPH
1	vodiace puzdro		1	6823, 6824, 6825R	151760-8	3,39 €
1	vodiace puzdro	1/4"	1	6821, 6826	152483-1	3,19 €
1	vodiace puzdro	3/8"	1	6821, 6826	152823-3	5,29 €
1	vodiace puzdro		1	FS2300, FS4000, FS4300, FS6300R	158875-2	5,39 €
2	tesniaci krúžok		1	6822, 6823, 6824, 6825R	421631-6	0,68 €
2	tesniaci krúžok		1	FS2300, FS4000, FS4300, FS6300R	424163-2	0,18 €
2	prachovka		1	6821	421519-0	0,59 €
2	prachovka		1	6826	421775-2	0,76 €
3	o-krúžok 22		1	6821, 6822, 6823, 6824, 6825R, 6826	213953-6	0,13 €
3	o-krúžok		1	FS2300, FS4000, FS4300, FS6300R	424235-3	0,13 €
4	nastavovacie puzdro		1	6822	416756-9	5,42 €
4	nastavovacie puzdro		1	6823, 6824, 6825R, 6827	455428-1	1,87 €
4	nastavovacie puzdro		1	6821	415570-0	1,91 €
4	nastavovacie puzdro		1	FS2300, FS4000, FS4300, FS6300R	455591-0	3,11 €
5	pružina		1	6822, 6823, 6824, 6825R, 6826, 6821	232154-7	1,24 €
5	pružina		1	FS2300, FS4000, FS4300, FS6300R	232245-4	1,12 €
5	pružina		1	FS2300, FS4000, FS4300, FS6300R	234266-2	1,21 €
4	nastavovacie puzdro		1	6823, 6824, 6825R, 6827	455428-1	1,87 €
	adaptér		1	6821, 6822, 6823, 6824, 6825R, 6826, 6827	134873-0	41,39 €

RÁZOVÉ ŤHAHOVÁKY: PRÍSLUŠENSTVO

	upínanie	typ	dĺžka mm	ks/bal	Obj. č.	MOC s DPH
Predĺženie *****	1/2"		75	1	B-55728	4,69 €
	1/2"		100	1	134874-8	30,19 €
	1/2"		250	1	B-55706	8,79 €
	3/4"		150	1	134997-2	53,19 €
	1"		200	1	134870-6	111,19 €



Kĺbový adaptér *****	1/2"		100	1	134877-2	97,29 €
--	------	--	-----	---	----------	---------



Adaptér redukcia *****	1/2" na 1/4"			1	134873-0	41,39 €
	1/2" na 1/4"			1	B-68448	16,69 €
	1/2" na 7/16"			1	B-68460	22,09 €
	1/2" na 1/4"			1	P-05941	53,39 €
	1/4" 6 hran na 1/4"			1	D-74740	1,49 €
	1/2" na 7/16" 6 hran			1	B-68460	22,09 €
	O krúžok pre P-05941			1	P-21559	3,07 €
	čap pre P-05941			1	P-21565	1,15 €



Nástrčné kľúče s upnutím štvorhran 1/2" *****	1/2"	M8/SW13	38	1	134825-1	4,59 €
	1/2"	M8/SW13	52	1	134827-7	6,49 €
	1/2"	M10/SW17	38	1	134829-3	5,39 €
	1/2"	M10/SW17	52	1	134830-8	7,09 €
	1/2"	M12/SW19	38	1	134831-6	4,69 €
	1/2"	M12/SW19	52	1	134832-4	6,09 €
	1/2"	1/2"/SW21	38	1	134838-2	5,89 €
	1/2"	1/2"/SW21	52	1	134833-2	5,69 €
	1/2"	M14/SW22	38	1	134851-0	5,69 €
	1/2"	M14/SW22	52	1	134834-0	7,19 €
	1/2"	M16/SW24	45	1	134841-3	8,19 €
	1/2"	M16/SW24	52	1	134836-6	8,29 €
	1/2"	M18/SW27	50	1	134844-7	9,09 €
	1/2"	M18/SW27	78	1	134845-5	11,89 €
	1/2"	M20/SW30	50	1	134846-3	8,89 €
	1/2"	M20/SW30	78	1	134847-1	12,69 €
	1/2"	M22/SW32	50	1	134848-9	9,29 €
	1/2"	M22/SW32	78	1	134849-7	15,29 €
	1/2"	O krúžok k nástrčným kľúčom		1	213405-7	0,23 €
	1/2"	čap k nástrčným kľúčom		1	268057-9	1,18 €









Nástrčné kľúče s upnutím štvorhran 1/2" *****	1/2"	M5/SW8	81,5	1	B-52146	4,49 €
	1/2"	M6/SW10	81,5	1	B-52152	4,49 €
	1/2"	SW12	81,5	1	B-52174	4,49 €
	1/2"	M8/SW13	81,5	1	B-52180	4,49 €
	1/2"	SW14	81,5	1	B-52196	4,99 €
	1/2"	SW16	81,5	1	B-52205	4,99 €
	1/2"	M10/SW17	81,5	1	B-52211	5,79 €
	1/2"	M12/SW19	81,5	1	B-52233	6,79 €
	1/2"	SW21	81,5	1	B-52249	7,69 €
	1/2"	SW22	81,5	1	B-52255	8,29 €
	1/2"	M16/SW24	81,5	1	B-52261	9,39 €
	1/2"	M18/SW27	81,5	1	B-52277	10,19 €
	1/2"	M20/SW30	81,5	1	B-52283	11,39 €
	1/2"	M22/SW32	81,5	1	B-52299	12,89 €

RÁZOVÉ UŤAHOVÁKY: PRÍSLUŠENSTVO

upínanie	typ	dĺžka mm	ks/bal	Obj. č.	MOC s DPH
Nástrčné kľúče s upnutím štvorhran 3/4" *****					
	M12/SW19	50	1	A-85519	11,09 €
	M14/SW22	52	1	A-85553	10,69 €
	M16/SW24	52	1	A-85575	9,79 €
	M18/SW27	52	1	134855-2	12,49 €
	M18/SW27	95	1	134856-0	23,99 €
	M20/SW30	52	1	134857-8	11,29 €
	M20/SW30	95	1	134858-6	22,29 €
	M22/SW32	52	1	134871-4	12,39 €
	M22/SW32	95	1	134859-4	22,39 €
	M24/SW36	56	1	134862-5	34,79 €
	M24/SW36	95	1	134863-3	25,89 €
	3/4"	O krúžok k nástrčným kľúčom		1	213506-1
3/4"	čap k nástrčným kľúčom		1	256282-4	1,25 €

Nástrčné kľúče s upnutím štvorhran 1" *****						
	1"	M24/SW36	80	1	134865-9	23,09 €
	1"	M27/SW41	80	1	134872-2	32,19 €

Sada nástrčných kľúčov 9ks B-54645 30,99 € (MOC s DPH) upínanie 1/2" 8, 10, 12, 13, 14, 15, 17, 18 x 30 mm adaptér 1/4" na 1/2"		Sada nástrčných kľúčov 3 ks E-12354 37,49 € (MOC s DPH) upínanie 1/2" kľúč 17, 19, 21 x 86 mm	
Sada nástrčných kľúčov 7ks B-69733 37,69 € (MOC s DPH) upínanie 1/2" 13, 17, 19, 21, 22, 24 x 30 mm adaptér 1/4" na 1/2"		Sada nástrčných kľúčov 9ks B-54651 21,99 € (MOC s DPH) upínanie 3/8" 8, 10, 12, 13, 14, 15, 17, 18 x 30 mm adaptér 1/4" na 3/8"	
Predĺženie k rázovým uťahovákam 191G67-2 136,89 € (MOC s DPH) vhodné pre modely DTW1001, DTW1002, DTW800 DTW700, TW001G, TW002G, TW003G, TW007G, TW008G nastavenie dĺžky: 657 – 807 mm		Sada nástrčných kľúčov 8ks E-12289 14,69 € (MOC s DPH) upínanie 1/4" 6; 7; 8; 10; 11; 12; 13; adaptér 1/4" na šesťhran	

Diamantové kotúče typy



Segmentový:

Najčastejšie používaný s diamantami v sadenými po okrajoch kotúča. Rýchle a pohodlné rezanie.



Segmentový zváraný laserom:

vrstva diamantu a kotúča sú zvárané laserovým lúčom nad 1000 °C. Ideálne použitie s vysoko výkonným strojom.

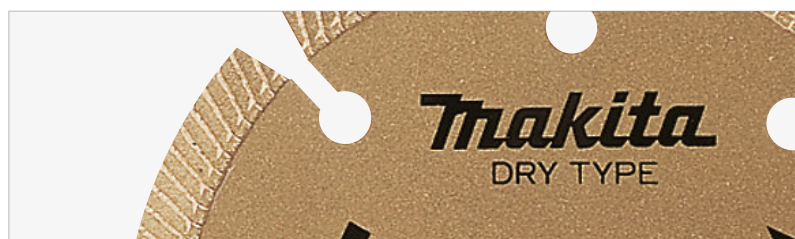

Segmentový so zárezmi:

tieto zárezy zabezpečujú:

- rýchle rezanie s menším odporom
- efektívnejšie odvádzanie rezného prachu
- menšia záťaž na kotúč

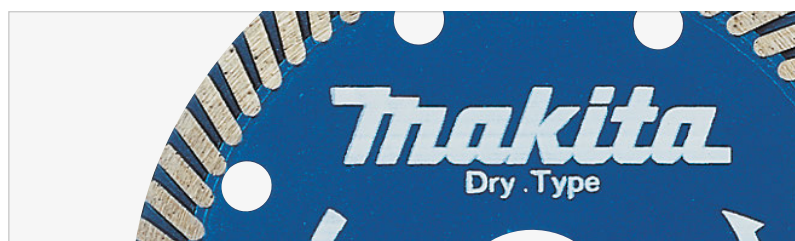

Turbo hrana:

rýchlejšie rezanie ako pri segmentových kotúčoch čistejší rez bez štrbín na rezanom materiále



Nedelená hrana:

Vrstva diamantov po celom obvode kotúča čistý a hladký rez aj na tvrdých materiáloch /keramické obklady, porcelán/

REZANIE: REZNÉ KOTUČE

upínanie ø otvoru (mm)	ø (mm)	materiál	typ	ks/bal	Obj. č.	MOC s DPH
------------------------------	--------	----------	-----	--------	---------	-----------

X-LOCK diamantový rezný kotúč



X-LOCK	125	betón	segmentový	1	E-02076	44,29 €
--------	-----	-------	------------	---	---------	---------

diamantový rezný kotúč určený pre akumulátorové uhlové brúsky X-LOCK – systém uchytenia kotúča bez použitia kľúča umožňuje bezpečnú a rýchlu výmenu kotúča možnosť použitia kotúča aj pre štandardné brúsky s upínaním 22,23 mm

Diamantový rezný kotúč pre akumulátorové uhlové brúsky



22,23	125	betón, žula, mramor	segmentový	1	B-53796	44,99 €
22,23	125	železo	segmentový	1	B-53693	50,09 €

Diamantový rezný kotúč pre akumulátorovú rozbrusovačku CE001



25,4	355	betón, žula, mramor	segmentový (výška segmentu 8 mm)	1	E-12996	161,59 €
------	-----	---------------------	-------------------------------------	---	---------	----------

Diamantový rezný kotúč na rezanie na mokrú



ø otvoru (mm)	ø (mm)	hrúbka segmentu (mm)	výška segmentu (mm)	materiál	typ	bal/ks	obj. č.	MOC s DPH
15	85	2	4,5	sklo, obkladačky	hladký	1	B-21098	33,49 €

vhodný pre modely 4190DW, 4191DWA, CC300, CC301



REZANIE: REZNÉ KOTUČE

ø (mm)	výška segmentu (mm)	ø otvoru (mm)	ID číslo kotúča	charakteristika	prstenec (mm)	ks/bal	Obj. č.	MOC s DPH
Diamantové kotúče Quasar *****								
230	12	22,23	QDS23022XS	3DDG, Stealth		1	B-12712	134,09 €
300	12	20	QDS30020XS	3DDG, Stealth		1	B-13459	184,89 €
350	12	25,4	QDS35025XS	3DDG, Stealth	20	1	B-13465	239,69 €
400	12	25,4	QDS40025XS	3DDG, Stealth	20	1	B-13471	280,89 €

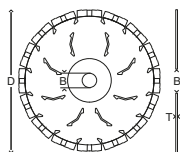

Ako čítať nový identifikačný kód diamantových kotúčov Makita



Typ segmentu (Segment Type)
 DS = diamantový segmentovaný
 DT = diamantový turbo
 DC = diamantový nedelený
 DE = diamantový elektrolyticky pokovovaný
 DM = diamantový na maltu (frézovanie škár)
 DA = diamantový asfaltový

Priemer otvoru (v mm) (Bore Diameter)
 15 = 15mm
 16 = 16mm
 20 = 20mm
 22 = 22.23mm
 25 = 25.4mm

QDS30020XS

Označenie (Brand)
 Q = Quasar
 C = Comet
 N = Neutron
 L = Laser (DiaMak+)
 D = DiaMak

Priemer kotúča (v mm)
 (Blade Diameter)

Špecifické charakteristiky
 (Special Features)
 e = Enduro
 r = Rapide
 C = chladiace otvory
 V = spevnené jadro
 X = technológia 3D Diamond Grid
 S = technológia Stealth



PRÍKLADY

QDS30020XS: kotúč Quasar, diamantový segmentovaný, priemer 300 mm, priemer otvoru 20 mm, technológia 3D Diamond Grid, technológia Stealth
 CDS40025rCX: kotúč Comet, diamantový segmentovaný, priemer 400 mm, priemer otvoru 25 mm, Rapide, chladiace otvory, technológia 3D Diamond Grid
 NDS11522e: kotúč Neutron – priemer 115 mm, priemer otvoru 22,23 mm, Enduro



REZANIE: REZNÉ KOTUČE

Špeciálny univerzálny kotúč s technológiou 3D Grid pre profesionálny výkon.

Široké spektrum kvalitných kotúčov s technológiou 3D Grid a voliteľnými prvkami ako technológia Stealth alebo chladiace otvory.

K dispozícii v segmentových špecifikáciách Rapide a Enduro pre maximalizáciu rýchlosti alebo životnosti.

Zvárané laserom. Na mokré a suché použitie.

ø (mm)	výška segmentu (mm)	ø otvoru (mm)	ID číslo kotúča	charakteristika	prstenec (mm)	ks./bal	Obj. č.	MOC s DPH
--------	---------------------	---------------	-----------------	-----------------	---------------	---------	---------	-----------

Diamantové kotúče Comet



	125	10	22,23	CDS12522rC	Rapide, chladiace otvory	20	1	B-12778	43,99 €
	150	10	22,23	CDS15022C	Rapide, chladiace otvory		1	B-27187	56,89 €
	180	10	22,23	CDS18022C	Rapide, chladiace otvory		1	B-27193	76,99 €
	230	10	22,23	CDS23022rCX	3DDG, Rapide, chladiace otvory		1	B-12784	102,39 €
	300	10	20	CDS30020rCX	3DDG, Rapide, chladiace otvory		1	B-13546	146,29 €
	350	10	25,4	CDS35025rCX	3DDG, Rapide, chladiace otvory	20	1	B-13552	170,19 €
	400	10	25,4	CDS40025rCX	3DDG, Rapide, chladiace otvory	20	1	B-13568	223,59 €

Segmentovaná hrana pre rýchle rezanie

Betón, stredne tvrdá/tvrdá tehla, terazzo, keramické dlaždice, bridlica, keramická rúra

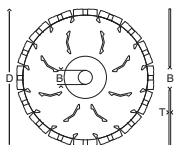

	115	7	22,23	CDT11522	štandardné jadro		1	B-12980	32,99 €
	125	7	22,23	CDT12522	štandardné jadro	20	1	B-12996	38,49 €
	200	7	30	CDT20030	štandardné jadro	25,4	1	B-13029	80,89 €
	230	8	22,23	CDT23022	štandardné jadro		1	B-13035	79,29 €
	300	8,5	25,4	CDT30025	štandardné jadro		1	B-13041	150,29 €
	350	8,5	25,4	CDT35025	štandardné jadro		1	B-13057	251,09 €

Turbo hrana na rezanie

Tvrdá tehla, žula, vápnenec, keramická rúra, bridlica, terazzo, granit



	80	5	15	CDC8015	štandardné jadro		1	B-13063	17,19 €
	115	5	22,23	CDC11522	štandardné jadro		1	B-13085	23,19 €
	125	5	22,23	CDC12522	štandardné jadro	20	1	B-13091	23,39 €
	200	5	30	CDC20030	štandardné jadro	25,4	1	B-13122	38,09 €
	230	5	30	CDC23030	štandardné jadro	25,4	1	B-13138	51,19 €
	300	7	25,4	CDC30025	štandardné jadro		1	B-13144	151,59 €
	350	7	30	CDC35030	štandardné jadro	25,4	1	B-13150	157,29 €

Nedelená hrana na rezanie keramiky, porcelánu, dlaždíc z mramoru a bridlice

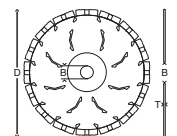

	115		22,23	CDE11522	štandardné jadro		1	B-13172	47,89 €
--	-----	--	-------	----------	------------------	--	---	---------	---------

Elektrolyticky pokovovaný kotúč na rezanie

Mramor, sklenené vlákno, drevovláknitá doska /sololit/, sklaminát



	300	10	20	CDA30020	štandardné jadro		1	B-13269	178,49 €
	350	10	25,4	CDA35025	štandardné jadro	20	1	B-13275	183,99 €
	400	10	25,4	CDA40025	štandardné jadro	20	1	B-42905	272,69 €

Segmentovaná hrana, asfaltový kotúč na rezanie

Asfalt, hrubozrný vápnenec, hrubozrný pieskovec, abrazívny pieskovec, mäkká tvárnica

REZANIE: REZNÉ KOTUČE

Špeciálny kotúč laserom zváraný na všeobecné použitie na stavebné materiály.
Možno použiť na mokré alebo suché rezanie.

ø (mm)	výška segmentu (mm)	ø otvoru (mm)	ID číslo kotúča	charakteristika	prstenec (mm)	ks/bal	Obj. č.	MOC s DPH
--------	---------------------	---------------	-----------------	-----------------	---------------	--------	---------	-----------

Diamantové kotúče Nebula

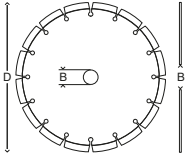

125	10	22,23		suchý rez		1	B-53992	21,09 €
150	10	22,23		suchý rez		1	B-54003	24,39 €
180	10	22,23		suchý rez		1	B-54019	30,49 €
230	10	22,23		suchý rez		1	B-54025	35,49 €
300	10	20		suchý/mokrý rez		1	B-54031	66,19 €
300	10	20		suchý/mokrý rez		1	B-54047	77,69 €
350	10	25,4		suchý/mokrý rez	20	1	B-54053	80,69 €
400	10	25,4		suchý/mokrý rez	20	1	B-54069	105,69 €
450	10	25,4		suchý/mokrý rez		1	B-54075	218,99 €

Segmentovaná hrana pre rýchle rezanie
Betón, mäkká tehla, mäkká bridlica, betónové dlaždice

Diamantové kotúče Diamak



Ekonomické kotúče vstupnej úrovne vhodné pre široké spektrum stavebných materiálov. K dispozícii vo viacerých variantoch – segmentované, turbo a nedelené. Na použitie za mokra aj za sucha.

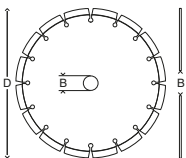

115	7	22,23	DDS115	Segmentový kotúč	za sucha	1	D-61123	6,99 €
125	7	22,23	DDS125	Segmentový kotúč	za sucha	1	D-61139	7,99 €
230	7	22,23	DDS230	Segmentový kotúč	za sucha	1	D-61145	18,79 €

Segmentovaná hrana – na rezanie
Väčšina murárskych materiálov, dosky, tehly, blokový pieskovec, bridlica a vápenec.

115	7	22,23	DDT115	Turbo hrana	za sucha	1	D-61151	7,39 €
125	7	22,23	DDT125	Turbo hrana	za sucha	1	D-61167	6,29 €
230	7	22,23	DDT230	Turbo hrana	za sucha	1	D-61173	21,49 €

Turbo hrana – na rezanie
Väčšina murárskych materiálov, dosky, tehly, blokový pieskovec, bridlica a vápenec.

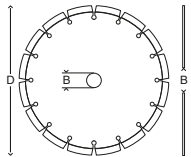

115	7	22,23	DDC115	nedelená hrana	za mokra	1	D-61189	6,49 €
200	7	25,4	DDC200	nedelená hrana	za mokra	1	D-61195	15,79 €
250	7	30 / 25,4	DDC250	nedelená hrana	za mokra	1	D-61204	20,19 €

Nedelená hrana – na rezanie
Na rezanie dlaždíc, mramoru, vápenca, porcelánu, terazza.



300	7,5	25,4	20	segmentový kotúč	za sucha	1	D-56982	72,89 €
350	7,5	25,4	20	segmentový kotúč	za sucha	1	D-56998	89,89 €
400	7,5	25,4	20	segmentový kotúč	za sucha	1	D-57009	78,79 €

Diamantové kotúče pre benzínové rozbrusovačky na betón

DELENIE: REZNÉ KOTÚČE

ø (mm)	výška segmentu (mm)	ø otvoru (mm)	ID číslo kotúča	charakteristika	pristenec (mm)	ks/bal	Obj. č.	MOC s DPH
--------	---------------------	---------------	-----------------	-----------------	----------------	--------	---------	-----------

Diamantové kotúče na betón pre uhlové brúsky



115	7	22,23		segmentový kotúč	za sucha	1	D-41589	8,99 €
125	7	22,23		segmentový kotúč	za sucha	1	D-41595	9,19 €
230	7	22,23		segmentový kotúč	za sucha	1	D-41610	25,89 €



115	7	22,23		turbo hrana	za sucha	1	D-41626	8,09 €
125	7	22,23		turbo hrana	za sucha	1	D-41632	9,89 €
230	7	22,23		turbo hrana	za sucha	1	D-41654	21,09 €

Diamantové brúsne kotúče pre PW5000



ø (mm)	farba kotúča	zrno	bal/ks	obj. č.	Moc s DPH
100	modrá	50	1	D-15584	15,69 €
100	žltá	100	1	D-15590	15,59 €
100	oranžová	200	1	D-15609	14,09 €
100	červená	400	1	D-15615	13,59 €
100	tmavozelená	800	1	D-15621	13,69 €
100	svetlozelená	1500	1	D-15637	16,39 €
100	hnedá	3000	1	D-15643	17,99 €
100	zelená	dolešťovanie	1	D-15659	22,29 €
100	sada 8 ks		8	D-15805	133,29 €
100	brúsny kotúč		1	743080-0	32,49 €

ø (mm)	ø otvoru (mm)	hrúbka segmentu (mm)	výška segmentu (mm)	druh segmentu	farba kotúča	použitie	max. otáčiky (min ⁻¹)	ks/bal	Obj. č.	MOC s DPH
--------	---------------	----------------------	---------------------	---------------	--------------	----------	-----------------------------------	--------	---------	-----------

Diamantový brúsny kotúč pre PC1100



110	15	13	5,4	hladký	strieborná		13900	1	792289-1	268,99 €
-----	----	----	-----	--------	------------	--	-------	---	----------	----------

Diamantový brúsny kotúč pre PC5000/5001



125	22,23	8	5	dvoj rad	zlatá	hrubé nečistoty		1	B-12295	115,39 €
125	22,23			hladký	zlatá	jemné čistenie		1	B-12289	231,39 €

Diamantový brúsny kotúč pre PC5000/5001



125	M14	8	5,5	jedno rad	strieborná	hrubé nečistoty		1	B-48561	83,49 €
125	M14	8	5,5	dvoj rad	strieborná	hrubé nečistoty		1	B-48577	92,99 €
125	M14	7	5,5	tvár V	strieborná	hrubé nečistoty		1	B-48583	93,89 €

125	22,23	7	5	dvoj rad	strieborná	hrubé nečistoty		1	D-41458	52,69 €
125	22,23	8	5	jedno rad	strieborná	hrubé nečistoty		1	D-60682	23,39 €
125	22,23	7	5,5	dvoj rad	strieborná	hrubé nečistoty	12.250	1	D-66715	34,39 €
125	22,23	13	4,2	vejárový	strieborná	hrubé nečistoty	12.250	1	D-66721	38,59 €

Diamantové brúsne kotúče z nízkymi vibráciami uchytenie M14



125	M14	7	5,5	tvár V	zlatá	hrubé nečistoty		1	B-48555	124,99 €
125	M14	15	4,5	vejárový	zlatá	hrubé nečistoty		1	B-49993	124,59 €

Príslušenstvo pre prestrihovače, nožnice na plech, nožnice závitových tyčí a roxorov



model	rozmer	popis	obj. č.	Moc s DPH
DSC102, SC103D	M6	sada 2 ks	199087-8	99,19 €
	M8	sada 2 ks	199085-2	77,19 €
	M10	sada 2 ks	199083-6	74,49 €
DSC162, DSC162R, DSC163		sada 2 ks	SC09002470	257,69 €
DSC191, DSC191R		sada 2 ks	SC09002030	341,99 €
DSC251	110 x 15 mm 24Z		E-11097	64,99 €
DSC250	110 x 15 mm 24Z		E-11097	64,99 €
	adaptér		SC09030550	85,69 €

model	pozícia	popis	obj. č.	MOC s DPH
-------	---------	-------	---------	-----------

DJS130, JS1300	1	nôž stredný	792744-3	55,49 €
----------------	---	-------------	----------	---------



DJS131	1	nôž stredný	725256-1	cena na vyžiadanie
--------	---	-------------	----------	--------------------

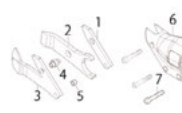

	2	nôž pravý	725257-9	cena na vyžiadanie
--	---	-----------	----------	--------------------

	3	nôž ľavý	725258-7	cena na vyžiadanie
--	---	----------	----------	--------------------

DJS200	1	nôž stredný	725255-3	cena na vyžiadanie
--------	---	-------------	----------	--------------------



	2	nôž pravý	725092-5	cena na vyžiadanie
--	---	-----------	----------	--------------------

	3	nôž ľavý	725093-3	cena na vyžiadanie
--	---	----------	----------	--------------------

DJS800	1	nôž stredný	725129-8	cena na vyžiadanie
--------	---	-------------	----------	--------------------

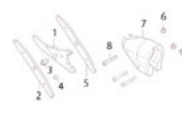

	2	nôž pravý	725130-3	cena na vyžiadanie
--	---	-----------	----------	--------------------

	5	nôž ľavý	725130-3	cena na vyžiadanie
--	---	----------	----------	--------------------

DJS100, DJS101, JS1000	1	Sada nožov (P + L)	792536-0	59,49 €
---------------------------	---	--------------------	----------	---------

	2	nôž stredný	792537-8	100,89 €
--	---	-------------	----------	----------



DJS160, DJS161, JS1601		Sada nožov (P + L)	792533-6	60,59 €
---------------------------	--	--------------------	----------	---------

		nôž stredný	792534-4	78,99 €
--	--	-------------	----------	---------

		mierka (0,5; 1,0; 1,5 mm)	762013-6	3,19 €
--	--	------------------------------	----------	--------



JS1602, JS1600	1; 2; 3	Sada nožov (P + L)	191383-0	35,09 €
----------------	---------	--------------------	----------	---------

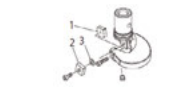

JS3201, JS3200	1; 2	Sada nožov (P + L)	792287-5	41,89 €
----------------	------	--------------------	----------	---------

		mierka (1,0; 1,5; 2,0 mm)	762007-1	2,39 €
--	--	-------------------------------	----------	--------



DJN160, DJN161, JN1601	1	matrica	A-15051	20,89 €
---------------------------	---	---------	---------	---------

	2	razník	A-83951	30,19 €
--	---	--------	---------	---------



JN3201, JN3200	1	matrica	792292-2	27,89 €
----------------	---	---------	----------	---------

	2	razník	792728-1	32,19 €
--	---	--------	----------	---------



Akumulátory, Odkladacie systémy, Vrtanie, Skrutkovanie, Brúsky, Pílenie, Frézovanie, Brúsenie, Klince / spony, Špeciálne stroje, Vysávanie, Fény/lampy, Záhrada, Ručné náradie, Ostatné

DELENIE: REZNÉ KOTÚČE

ø (mm)	ø otvoru (mm)	popis	hrúbka kotúča	ks/bal	Obj. č.	MOC s DPH
--------	---------------	-------	---------------	--------	---------	-----------

Rezné kotúče

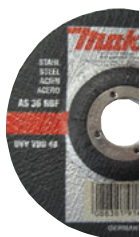

Rezný kotúč na kovy – Rezný kotúč, lisovaný za studena, s pojivom zo syntetickej živice. Univerzálny kotúč, použiteľný vo všetkých oblastiach opracúvania kovov. Vysoký rezný výkon pri dobrej životnosti.

115	22,23		1,6	1	B-14102	1,59 €
115	22,23		2,5	1	A-85307	1,39 €
125	22,23		1,6	1	B-35134	1,79 €
125	22,23		2,5	1	A-85313	1,69 €
180	22,23		2,5	1	A-85329	2,39 €
230	22,23		2,5	1	A-85335	3,29 €
230	22,23		2	1	B-60464	3,39 €
355	25,4		2,5	5	B-49448-5*	31,99 €
355	25,4		3	5	B-10665-5	28,79 €
355	25,4		4,3	5	E-12790-5	80,49 €
400	25,4		3	1	724417-0	38,79 €

Sada rezných kotúčov na kov

125	22,23	kovová krabica	1,2	12	D-65969-12	12,29 €
125	22,23	PVC krabica	0,8	12	E-10877-12	25,89 €



Rezný kotúč na kameň – Rezný kotúč, lisovaný za studena, s pojivom zo syntetickej živice. Univerzálny kotúč na rezanie prírodného a umelého kameňa, bridlice, mramoru, neželezných kovov. Vysoký rezný výkon pri dlhej životnosti

125	22,23		3	1	A-85363	2,19 €
180	22,23		3	1	A-85379	3,09 €
230	22,23		3	1	A-85385	4,19 €
300	20		3,5	1	721710-3	17,19 €
400	25,4		4	1	724408-1	38,79 €



Rezný kotúč na nerez / železo – Tenký, stredne tvrdý, vysokovýkonný rezný kotúč. Vhodný najmä na tenkostenné materiály ako rúry, profily, plechy a drôty. Nižšie zaťaženie náradia, menšia spotreba materiálu, menšie úsilie pri rezaní. Mimoriadne vysoký rezný výkon pri optimálnej životnosti.

76	10	Kartón	1	5	D-74815-5	3,69 €
115	22,23		0,8	1	B-45727	1,89 €
115	22,23		1,6	1	B-45755	1,39 €
125	22,23		0,8	1	E-10877	2,19 €
125	22,23		1,6	1	B-46931	1,49 €
125	22,23	PVC krabica	1	12	E-17120-12	17,59 €

Rezný kotúč na ušľachtilú oceľ – Tenký, stredne tvrdý, vysokovýkonný rezný kotúč. Vhodný najmä na tenkostenné materiály ako rúry, profily, plechy a drôty z nehrdzavejúcej ocele. Nižšie zaťaženie náradia, menšia spotreba materiálu, menšie úsilie pri rezaní. Mimoriadne vysoký rezný výkon pri optimálnej životnosti.

100	16		1	1	E-03028	1,69 €
115	22,23		1	1	E-03034	1,69 €
125	22,23		1	1	E-03040	1,89 €
150	22,23		1,6	1	E-13742	2,19 €
180	22,23		1,6	1	E-13758	2,19 €
230	22,23		1,9	1	E-13764	3,79 €

* do vypredania skladových zásob

DELENIE: BRÚSNE KOTÚČE

ø (mm)	ø otvoru (mm)	popis	hrúbka kotúča	ks/bal	Obj. č.	MOC s DPH
--------	---------------	-------	---------------	--------	---------	-----------

Rezné kotúče



Rezný kotúč na hliník – Rezný kotúč, lisovaný za studena, s pojivom zo syntetickej živice. Vhodný na rezanie hliníkových materiálov. Vysoký rezný výkon pri dlhej životnosti.

125	22,23		1	1	B-45331	1,99 €
150	22,23		1,6	1	B-45347	2,29 €
230	22,23		1,9	1	B-45369	4,09 €

2 v 1 rezný / brúsny kotúč na nerez a železo, vhodný pre akumulátorové brúsky

115	22,23		2	1	B-50360	1,99 €
-----	-------	--	---	---	---------	--------

Multi rezný kotúč na kov, nerez, PVC, obkladačky, tehly, betón

125	22,23		1,2	1	E-10724	1,99 €
-----	-------	--	-----	---	---------	--------

Brúsny kotúč na oceľ a nehrdzavejúcu oceľ



Brúsne kotúče Makita sú stredne tvrdé univerzálne kotúče, určené pre všetky oblasti opracovania kovov. Brúsne kotúče majú hrubú zrnitosť a používajú sa na miestach, kde sa požaduje vysoký úberový výkon. Vzhľad výbrusu je zodpovedajúco hrubý.

Oblasti využitia: začisťovanie zvarov; brúsenie liatinových odliatok; brúsenie hrán a plôch; brúsenie rohových zvarov; brúsenie bodových zvarov; zahľadzovanie a výbrus okovín.

115	22,23		6	1	A-80640	1,89 €
125	22,23		4	1	B-53110	2,79 €
125	22,23		6	1	A-80656	2,49 €
150	22,23		6	1	A-80846	2,89 €
180	22,23		6	1	A-80880	4,19 €
230	22,23		6	1	A-80896	6,59 €
115	22,23		6	1	B-14560	2,29 €
180	22,23		6	1	B-14576	3,29 €

Brúsny kotúč na kov



Stredne tvrdý, univerzálny brúsny kotúč na celkové opracovanie normálnej ocele, napr. na odstraňovanie okovín, brúsenie hrán a výbrus plôch.

Mimoriadnou prednosťou tohto kotúča je optimálny pomer ceny a výkonu.

115	22,23		6	1	D-18459	1,39 €
115	22,23		6	1	A-80927	1,59 €
125	22,23		6	1	A-80933	1,79 €
150	22,23		6	1	A-84981	2,49 €
180	22,23		6	1	A-80949	2,79 €
230	22,23		6	1	A-80955	4,79 €

Brúsny kotúč HEAVY DUTY na kov, železo a nerez



Univerzálny, stredne tvrdý brúsny kotúč, lisovaný za studena, s pojivom zo syntetickej živice, na celkové opracovanie ocele, napr. na odstraňovanie okovín, brúsenie hrán a výbrus plôch.

Mimoriadnou prednosťou tohto kotúča je vysoký úberový výkon pri optimálnej životnosti.

115	22,23		6	1	B-21113	1,39 €
125	22,23		6	1	B-21129	1,79 €
180	22,23		6	1	B-21135	2,49 €
230	22,23		6	1	B-21141	4,49 €

Brúsny kotúč



Štruktúra



Špeciálny kotúč na odstraňovanie farieb

Grit (SiC)

Štruktúra kotúča SiC (karbid kremíka) a vlákna umožňujú rýchle a zároveň šetrné brúsenie materiálu bez väčšej námahy.

Fiber

Zapuzdrené vlákna pôsobia šetrne na materiál a zabraňujú prílišnému odbrúseniu a poškrabaniu ocele.

Vlastnosti

Rozdiel pri použití na rovnakom materiáli.



špeciálny kotúč

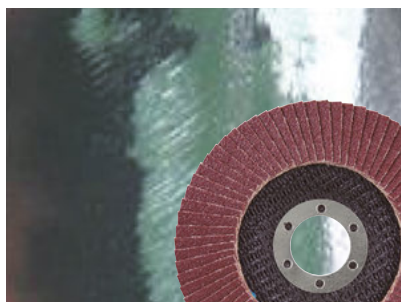

lamelový kotúč

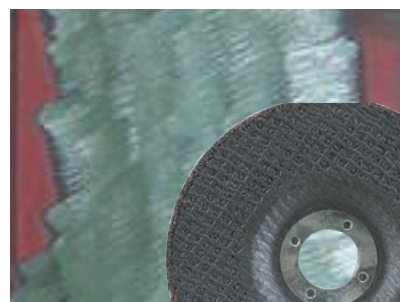

brúsny kotúč

Použitie

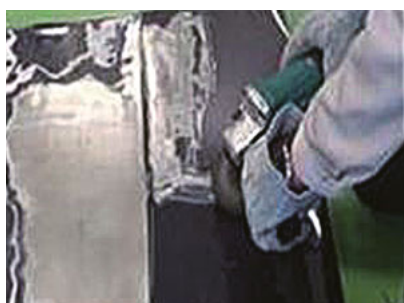

*odstraňovanie farby



*odstraňovanie hrdze



*odstraňovanie farebných defektov po zvaroch

Lamelové kotúče



Typ uchytienia



podložka zo sklenených vlákién
štandardný typ podkladu



nylónová podložka
For heavy duty

Tvar kotúča



plochý
pre rovné povrchy

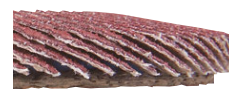

zaoblený
použitie pri uhloch a rohoch

AA : odporúčané

A : prijateľný

zloženie brusiva	Aluminum oxide	Zirconia alumina	Silicon carbide	Ceramic aluminum oxide
popis a farba štítka	určený na železo 	určený na železo a nerez 	určený na murivo 	určený na železo, nerez a neželezné kovy
drevo	A			
PVC	A			
železo	AA	AA		AA
neželezné kovy	A	A		AA
nerez		AA		AA
murivo			AA	

ø (mm)	ø otvoru (mm)	zrניות	max. otáčky	ks/bal	Obj. č.	MOC s DPH
--------	---------------	--------	-------------	--------	---------	-----------

Lamelový brúsny kotúč na ušľachtilú oceľ „Zirkón“

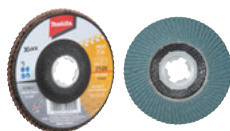

Brúsne zmo zo zirkónového korundu je vhodné najmä na agresívny výbrus a vysoké namáhanie a je preto optimálne ako na hrubý úber, tak aj na finálny výbrus a leštenie tvrdej ocele. Vhodný materiál: ušľachtilá oceľ; neželezné kovy a ich zliatiny; rôzne stavebné ocele; hliník; drevo; liatina.

125	X-LOCK	40	12.500	1	D-76009	6,39 €
125	X-LOCK	60	12.500	1	D-76015	5,99 €
125	X-LOCK	80	12.500	1	D-76021	5,99 €
125	X-LOCK	120	12.500	1	D-76037	5,99 €

BRÚSENIE: LAMELOVÉ KOTÚČE

ø (mm)	ø otvoru (mm)	zrnitosť	max. otáčky	ks/bal	Obj. č.	MOC s DPH
--------	---------------	----------	-------------	--------	---------	-----------

Lamelové brúsne kotúče na ocel' „Korund“



Brúsne zrna z korundu je vhodné najmä na brúsenie mäkkej ocele. Lamelové brúsne kotúče sú optimálne ako na hrubý výbrus, tak aj na finálny výbrus a leštenie.

Brúsne listy kotúča majú vejárovité usporiadanie, navzájom sa prekrývajú a sú upevnené na vysokokvalitnom kotúči s vláknami zo sklolaminátu.

Najdôležitejšie prednosti lamelových brúsnych kotúčov: vysoký a konštantný úberový výkon, studený výbrus; vysoká kvalita výbrusu; dlhá životnosť; nízka hlučnosť.

Oblasti využitia: odhrdzovanie; výbrus odliatok; znášanie hrán; výbrus plôch; odstraňovanie farieb/tmelov; finálny výbrus.

Vhodný materiál: hliník; mäkké neželezné kovy a ich zliatiny; rôzne stavebné ocele; plasty; drevo; liatina.

115	22,23	40	13 300	1	P-65137	2,79 €
115	22,23	60	13 300	1	P-65143	2,79 €
115	22,23	80	13 300	1	P-65159	2,79 €
115	22,23	120	13 300	1	P-65165	2,79 €
125	22,23	40	12 000	1	P-65171	3,29 €
125	22,23	60	12 000	1	P-65187	3,29 €
125	22,23	80	12 000	1	P-65193	3,29 €
125	22,23	120	12 000	1	P-65202	3,29 €
150	22,23	40	10 200	1	P-65218	4,89 €
150	22,23	60	10 200	1	P-65224	4,79 €
150	22,23	80	10 200	1	P-65230	4,79 €
180	22,23	40	8 600	1	P-65252	6,79 €
180	22,23	60	8 600	1	P-65268	6,79 €
180	22,23	80	8 600	1	P-65274	7,09 €

Lamelový brúsny kotúč na ušľachtilú ocel' „Zirkón“



Brúsne zrna zo zirkónového korundu je vhodné najmä na agresívny výbrus a vysoké namáhanie a je preto optimálne ako na hrubý úber, tak aj na finálny výbrus a leštenie tvrdej ocele.

Brúsne listy kotúča majú vejárovité usporiadanie, navzájom sa prekrývajú a sú upevnené na vysokokvalitnom kotúči s vláknami zo sklolaminátu.

Najdôležitejšie prednosti lamelových brúsnych kotúčov: mimoriadne vysoký a konštantný úberový výkon; vysoká kvalita povrchu; dlhá životnosť; nízka hlučnosť.

Oblasti využitia: odstraňovanie okovín; výbrus odliatok; znášanie hrán; výbrus plôch; odstraňovanie hrdze/tmelov; finálny výbrus.

Vhodný materiál: ušľachtilá ocel'; neželezné kovy a ich zliatiny; rôzne stavebné ocele; hliník; drevo; liatina.

115	22,23	40	13 300	1	P-65458	2,79 €
115	22,23	60	13 300	1	P-65464	2,79 €
115	22,23	80	13 300	1	P-65470	2,79 €
115	22,23	120	13 300	1	P-65486	2,79 €
125	22,23	40	12 000	1	P-65492	3,39 €
125	22,23	60	12 000	1	P-65501	3,39 €
125	22,23	80	12 000	1	P-65517	3,39 €
125	22,23	120	12 000	1	P-65523	3,39 €
150	22,23	40	10 200	1	P-65539	5,09 €
150	22,23	60	10 200	1	P-65545	5,09 €
150	22,23	80	10 200	1	P-65551	5,09 €
150	22,23	120	10 200	1	P-65567	5,09 €
180	22,23	40	8 600	1	P-65573	7,19 €
180	22,23	60	8 600	1	P-65589	7,19 €
180	22,23	80	8 600	1	P-65595	7,09 €
180	22,23	120	8 600	1	P-65604	7,19 €

Lamelové brúsne kotúče na kameň



Brúsne zrna z karbidu kremíka má tvrdú štruktúru s ostrými hranami a je vhodné najmä na brúsenie tvrdých a húževnatých materiálov s nízkou pevnosťou v ťahu.

Brúsne listy kotúča majú vejárovité usporiadanie, navzájom sa prekrývajú a sú upevnené na vysokokvalitnom kotúči s vláknami zo sklolaminátu.

Najdôležitejšie prednosti lamelových brúsnych kotúčov: vysoký a konštantný úberový výkon, studený výbrus; vysoká kvalita povrchu; dlhá životnosť; nízka hlučnosť.

Oblasti využitia: znášanie hrán; výbrus plôch; brúsenie hrán; finálny výbrus.

Vhodný materiál: kameň; sklo; keramika; plasty.

115	22,23	40	13 300	1	P-65296	2,79 €
115	22,23	60	13 300	1	P-65305	2,79 €
115	22,23	80	13 300	1	P-65311	2,79 €
115	22,23	120	13 300	1	P-65327	2,79 €
125	22,23	40	12 000	1	P-65333	3,29 €
125	22,23	60	12 000	1	P-65349	3,29 €
125	22,23	80	12 000	1	P-65355	3,29 €
125	22,23	120	12 000	1	P-65361	3,29 €
150	22,23	40	10 200	1	P-65377	4,89 €
150	22,23	60	10 200	1	P-65383	4,99 €
150	22,23	80	10 200	1	P-65399	4,89 €
150	22,23	120	10 200	1	P-65408	5,39 €
180	22,23	40	8 600	1	P-65414	6,99 €

BRÚSENIE: LAMELOVÉ KOTUČE

ø (mm)	ø otvoru (mm)	zrnitosť	max. otáčky	ks/bal	Obj. č.	MOC s DPH
--------	---------------	----------	-------------	--------	---------	-----------

Lamelové brúsne kotúče na kov



Lamelové brúsne kotúče sú vyrobené z Aluminium oxidu určené na brúsenie kovov, neželezných kovov, PVC a dreva

Podložka zo sklenených vlákien, tvar kotúča zaoblený.



115	22,23	40	13 300	10	D-63432-10	11,49 €
115	22,23	60	13 300	10	D-63448-10	11,39 €
115	22,23	80	13 300	10	D-63454-10	14,29 €
115	22,23	120	13 300	10	D-63460-10	11,49 €
125	22,23	40	12 000	10	D-63476-10	17,99 €
125	22,23	60	12 000	10	D-63482-10	16,19 €
125	22,23	80	12 000	10	D-63498-10	16,79 €
125	22,23	120	12 000	10	D-63507-10	16,49 €

Lamelové brúsne kotúče na kov



Lamelové brúsne kotúče sú vyrobené zo Zirkon aluminium určené na brúsenie kovov, neželezných kovov a nerez

Podložka zo sklenených vlákien, tvar kotúča zaoblený.



115	22,23	40	13 300	10	D-63747-10	16,09 €
115	22,23	60	13 300	10	D-63753-10	16,19 €
115	22,23	80	13 300	10	D-63769-10	15,49 €
115	22,23	120	13 300	10	D-63775-10	15,49 €
125	22,23	40	12 000	10	D-63781-10	24,89 €
125	22,23	60	12 000	10	D-63797-10	22,09 €
125	22,23	80	12 000	10	D-63806-10	21,79 €
125	22,23	120	12 000	10	D-63812-10	22,49 €

Lamelové brúsne kotúče na nerez



Lamelové brúsne kotúče sú vyrobené zo Zirkon aluminium určené na brúsenie kovov, neželezných kovov a nerez

Podložka zo sklenených vlákien, tvar kotúča zaoblený.



125	22,23	40	12200	1	B-53920	6,99 €
125	22,23	60	12200	1	B-53936	7,69 €
125	22,23	80	12200	1	B-53942	7,49 €
115	22,23	40	13.300	1	D-74186	2,09 €
115	22,23	60	13.300	1	D-74192	2,09 €
115	22,23	80	13.300	1	D-74201	1,99 €
115	22,23	120	13.300	1	D-74217	1,99 €
125	22,23	40	13.300	1	D-74223	2,29 €
125	22,23	60	13.300	1	D-74239	2,29 €
125	22,23	80	13.300	1	D-74245	2,29 €
125	22,23	120	13.300	1	D-74251	2,29 €

Brúsny kotúč na odstraňovanie farby



Špeciálne brúsne kotúče určené na odstraňovanie farby a hrdzu, vďaka zapleteným vláknam, vyrobených z karbidu hliníka, ktoré umožňujú rýchle brúsenie s menším odporom a slúžia ako poduška, ktorá zabraňuje nadmernému brúseniu a poškrabaniu obrobku. Výborne sa prispôbujú aj nerovnému opracovanému povrchu.

Vhodný materiál: nerez, železo, neželezné kovy.



ø (mm)	ø otvoru (mm)	popis/farba kotúča	max. otáčky	bal/ks	obj. č.	MOC s DPH
115	22,23	štandard / čierna	12 000	1	B-28977	10,59 €
125	22,23	štandard / čierna	12 000	1	B-28983	12,39 €
115	22,23	Longlife / fialová	12 000	1	B-29016	11,29 €
125	22,23	Longlife / fialová	12 000	1	B-29022	14,49 €

DELENIE: BRÚSNE KOTÚČE

ø (mm)	ø otvoru (mm)	zrŕitosť	ks/bal	Obj. č.	MOC s DPH
--------	---------------	----------	--------	---------	-----------

Fibrový brúsny list „Korund“



Brúsny list so zrnom z korundu, upevneným na fíbrovej podložke pomocou pojiva zo syntetickej živice. Podložka je vyrobená z mimoriadne pevnej tkaniny zo sklenených vlákien. Používa sa s elastickým brúsnym tanierom. Oblasti využitia: odhrdzovanie a čistenie kovových povrchov; výbrus starých lakov a podkladových vrstiev; zarovnávanie zvarov a zahladzovanie, výbrus hrán; odstraňovanie okovín a výbrus nádrží a prístrojov

115	13	24	5	P-00860	4,39 €
115	13	36	5	P-00876	4,79 €
115	13	40	5	P-00882	4,79 €
115	13	50	5	P-00898	4,39 €
115	13	60	5	P-00907	4,79 €
115	13	80	5	P-00913	4,79 €
115	13	100	5	P-00929	4,79 €
125	13	24	5	P-00957	5,69 €
125	13	36	5	P-00963	5,69 €
125	13	40	5	P-00979	5,69 €
125	13	60	5	P-00985	5,69 €
125	13	80	5	P-00991	5,69 €
125	13	100	5	P-01002	5,69 €
125	13	120	5	P-01018	5,69 €
180	13	16	5	P-01024	8,49 €
180	13	24	5	P-01030	7,39 €
180	13	36	5	P-01046	7,39 €
180	13	40	5	P-01052	7,39 €
180	13	60	5	P-01074	7,39 €
180	13	80	5	P-01080	7,39 €
180	13	100	5	P-01096	7,39 €
180	13	120	5	P-01105	6,69 €

Brúsny papier 180 mm, neperforovaný k brúsnemu kotúču 743053-3

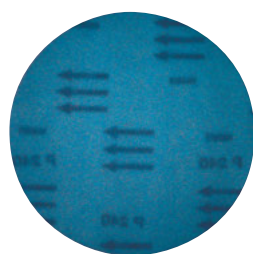

Vhodné pre farebné kovy, plasty, drevo, drevo s klinkami, kov, kameň.

ø (mm)	popis	zrŕitosť	bal/ks	obj. č.	MOC s DPH
180	suchý zip	80	10	P-33445	9,09 €
180	suchý zip	120	10	P-33451	8,29 €
180	suchý zip	240	10	P-38059	8,09 €
180	suchý zip	400	10	P-38087	8,09 €

Gumové tanier



ø (mm)	bal/ks	obj. č.	MOC s DPH
115	1	P-05882	4,49 €
125	1	P-05898	4,89 €
150	1	P-05907	7,59 €
180	1	P-05913	7,09 €

PRÍSLUŠENSTVO

Multi Tool



Karbid z volfrámu, #30



Karbid z volfrámu, #30



Diamantové zrno, #40



Zúbkovaná hrana



Ostrá hrana



Ostrá hrana



Delta doska



Brúsna doska

Príslušenstvo

Multi Tool

STARLOCK



Vhodné pre aplikácie

✓ = vhodné

Farebné rozlíšenie pre aplikácie

šírka (mm)	počet zubov na palec	materiál	zakrivené zuby
------------	----------------------	----------	----------------



drevo a kov



drevo



kov



Multi Material



škárovacia hmota

	šírka (mm)	počet zubov na palec	materiál	zakrivené zuby
TMA045	85	18	BiM	
TMA046	100	15	BiM	
TMA047	32	20	BiM	●
TMA048	65	20	BiM	●
TMA057	10	20	BiM	
TMA058	20	20	BiM	
TMA049	85	18	HCS	
TMA050	24	18	HCS	
TMA051	32	18	HCS	●
TMA052	65	20	HCS	●
TMA053	32	14	BiM	●
TMA054	32	14	HCS	●
TMA055	65	14	BiM	●
TMA056	65	14	HCS	●
TMA059	32	20	BiM	
TMA060	20	23	TC	
TMA061	32	23	TC	
TMA079	45	23	TC	
TMA063	100	-	BiM	
TMA064	85	18	BiM	
TMA065	52	-	HCS	
TMA066	52	-	HCS	
TMA067	28	-	HCS	
TMA068	11	-	HCS	
TMA080	32	20	TC	●
TMA081	53	14	BiM	●
TMA082	12	-	Stainless	
TMA069	85	-	TC #30	
TMA070	85	-	Diamond	
TMA071	70	-	TC #50	
TMA072	85	-	TC #40	
TMA073	78	-	TC #20	
TMA074	70	-	TC #40	
TMA075	32	-	TC #50	
TMA076	32	-	TC #40	
TMA077	32	-	TC #100	
TMA083	90	-	TC #20	
TMA084	90	-	TC #40	
TMA085	90	-	TC #60	
TMA086	90	-	TC #100	

drevo a kov								
drevo					kov			
drevo	preglečka	drevotrieska	laminát	sadrokartón	neželezné kovy	plechy	nerez	mäkky kliniec
✓	✓	✓	✓	✓	✓	✓		✓
✓	✓	✓	✓	✓	✓			✓
✓	✓	✓	✓	✓	✓	✓		✓
✓	✓	✓	✓	✓	✓	✓		✓
✓	✓	✓	✓	✓	✓	✓		✓
✓	✓	✓	✓	✓	✓	✓		✓
✓	✓	✓	✓					
✓	✓	✓	✓					
✓	✓	✓	✓	✓				
✓	✓	✓	✓	✓				
✓	✓	✓	✓	✓	✓	✓		✓
✓	✓	✓	✓	✓	✓	✓	✓	✓
✓	✓	✓	✓	✓	✓	✓	✓	✓
✓	✓	✓	✓	✓	✓	✓	✓	✓
✓	✓	✓	✓	✓	✓	✓		✓
✓	✓	✓	✓	✓	✓	✓	✓	✓
✓	✓	✓	✓	✓	✓	✓	✓	✓
				✓				
				✓				
				✓				
				✓				
✓								
✓	✓			✓				
✓	✓			✓				
✓	✓	✓						
✓	✓	✓						
✓								
✓	✓							
✓	✓	✓						
✓	✓	✓						

Príslušenstvo

Multi Tool

STARLOCK PLUS STARLOCK MAX

Vhodné pre aplikácie
✓ = vhodné



Farebné rozlíšenie pre aplikácie

šírka (mm)	počet zubov na palec	materiál	zakrivené zuby
------------	----------------------	----------	----------------

drevo a kov								
drevo					kov			
drevo	preglejka	drevotrieska	laminát	sadrokartón	neželezné kovy	plechy	nerez	mäkký klinec

STARLOCK PLUS



drevo a kov

MAP001	32	20	BiM	●
MAP002	65	20	BiM	●

✓	✓	✓	✓	✓	✓	✓		✓
✓	✓	✓	✓	✓	✓	✓		✓



drevo

MAP003	32	18	HCS	●
--------	----	----	-----	---

✓	✓	✓	✓					
---	---	---	---	--	--	--	--	--



kov

MAP004	32	23	TC	
MAP005	45	23	TC	

✓	✓	✓	✓	✓	✓	✓	✓	✓
✓	✓	✓	✓	✓	✓	✓	✓	✓



Multi Material

MAP006	32	20	TC	●
MAP007	52	20	TC	●

✓	✓	✓	✓	✓	✓	✓	✓	✓
✓	✓	✓	✓	✓	✓	✓	✓	✓



škárovacia hmota

MAP008	53	-	TC #40	
--------	----	---	--------	--

✓		✓		✓	✓			✓
---	--	---	--	---	---	--	--	---

STARLOCK MAX



drevo a kov

MAM001	32	20	BiM	●
MAM002	52	18	BiM	●
MAM003	100	15	BiM	

✓	✓	✓	✓	✓	✓	✓		✓
✓	✓	✓	✓	✓	✓	✓		✓
✓	✓	✓	✓		✓			✓



drevo

MAM004	32	18	HCS	●
--------	----	----	-----	---

✓	✓	✓	✓					
---	---	---	---	--	--	--	--	--



kov

MAM005	32	23	TC	
--------	----	----	----	--

✓	✓	✓	✓	✓	✓	✓	✓	✓
---	---	---	---	---	---	---	---	---



Multi Material

MAM006	32	20	TC	●
MAM007	32	-	HCS	
MAM008	32	-	HCS	

✓	✓	✓	✓	✓	✓	✓	✓	✓



škárovacia hmota

MAM009	68	-	TC #50	
MAM010	68	-	TC #30	
MAM011	68	-	Diamond	
MAM012	68	-	Diamond	
MAM013	68	-	TC #40	
MAM014	100	-	TC #40	
MAM015	116	-	TC #20	
MAM016	116	-	TC #40	
MAM017	116	-	TC #60	
MAM018	116	-	TC #100	

				✓				
				✓				
				✓				
				✓				
				✓				
✓	✓			✓	✓			✓
✓	✓	✓						
✓	✓	✓						
✓	✓	✓						
✓	✓	✓						



Multi Material					škárovacia hmota			
epoxydy	sklolaminát	linoleum	lepidlo na koberce	izolačný materiál	mäkký spojovací materiál	porézny betón, mäkká tehla	mäkké obklady stien	malta, lepidlo na dlaždice

zakrivené zuby	materiál	počet zubov na palec	šírka (mm)
----------------	----------	----------------------	------------

✓	✓							
✓	✓							
✓								
✓	✓					✓		
✓	✓							
✓	✓					✓		
✓	✓					✓		
✓						✓		

●	BiM	20	32	MAP001
●	BiM	20	65	MAP002
●	HCS	18	32	MAP003
	TC	23	32	MAP004
	TC	23	45	MAP005
●	TC	20	32	MAP006
●	TC	20	52	MAP007
	TC #40	-	53	MAP008

Farebné rozlíšenie pre aplikácie



✓	✓							
✓	✓							
✓								
✓	✓					✓		
✓	✓					✓		
						✓		
				✓	✓			
				✓	✓			

●	BiM	20	32	MAM001
●	BiM	18	52	MAM002
	BiM	15	100	MAM003
●	HCS	18	32	MAM004
	TC	23	32	MAM005
●	TC	20	32	MAM006
	HCS	-	32	MAM007
	HCS	-	32	MAM008



✓	✓					✓	✓	✓
✓	✓					✓	✓	✓
✓	✓					✓	✓	✓
✓	✓					✓	✓	✓
✓	✓					✓	✓	✓
✓	✓					✓	✓	✓
	✓							✓
	✓							✓
								✓
								✓

	TC #50	-	68	MAM009
	TC #30	-	68	MAM010
	Diamond	-	68	MAM011
	Diamond	-	68	MAM012
	TC #40	-	68	MAM013
	TC #40	-	100	MAM014
	TC #20	-	116	MAM015
	TC #40	-	116	MAM016
	TC #60	-	116	MAM017
	TC #100	-	116	MAM018



DELENIE: PRÍSLUŠENSTVO PRE MULTITOOL



Compatibility with models		Blade Shank		
Tool Shank	OIS Compatible Tools	✓	-	-
	STARLOCK MAX	✓	✓	✓

ø (mm)	materiál	TPI/ zrornosť	použitie	označenie	Obj. č.	MOC s DPH
--------	----------	------------------	----------	-----------	---------	-----------

Pílavy kotúč



85	HCS	18	drevo	TMA049	B-64836	15,19 €
100	BiM	15	drevo / kov	TMA046	B-64808	23,89 €
85	BiM	18	drevo / kov	TMA045	B-64799	18,89 €
85	BiM-TiN	18	multi	TMA064	B-64973	23,69 €

Segmentový pílový kotúč s tvrdokovom



85	HM/RIFF	30	rezanie špár	TMA069	B-65028	26,99 €
85	DIA	40	rezanie špár, kachličiek a FRP	TMA070	B-65034	44,29 €
65	HM/TC	50	rezanie tenkých špár (1,6 mm)	TMA071	B-65040	22,39 €
32 x 30	HM/TC	50	fibrové sklo, malta	TMA075	B-65084	22,59 €

Nástroje na odstraňovanie vrstiev materiálu



52 x 26	HCS		odstraňovanie malty, lepidla	TMA065	B-64989	8,19 €
52 x 45	HCS		odstraňovanie lepidiel a silikónu	TMA066	B-64995	8,19 €
28 x 40	HCS		tmel silikón	TMA067	B-65006	16,09 €
12 x 29	HCS		tmel silikón	TMA082	B-69783	18,29 €

Rezné nástroje





11 x 24	HCS		koberce, lino	TMA068	B-65012	18,19 €
100	BiM		polystyrén, guma, izol. materiál	TMA063	B-64967	24,59 €
32 x 50	BiM	20	kov	TMA059	B-64939	11,79 €
20 x 30	BiM	20	kov	TMA058	B-64923	8,19 €
10 x 30	BiM	20	kov	TMA057	B-64917	8,09 €
65 x 40	HCS	20	drevo	TMA052	B-64864	11,99 €
32 x 50	BiM	14	drevo	TMA053	B-64870	13,19 €
32 x 50	HCS	18	drevo	TMA51	B-64858	9,89 €
24 x 50	HCS	18	drevo	TMA050	B-64842	9,09 €
65 x 40	BiM	20	kov, drevo	TMA048	B-64820	16,79 €
32 x 50	BiM	20	kov, drevo	TMA047	B-64814	12,69 €
45	TC/HM	23	kov	TMA079	B-69755	21,99 €
32	TC/HM	20	multi	TMA080	B-69761	21,99 €
53	BiM	14	sadrokartón	TMA081	B-69777	13,69 €

DELENIE: PRÍSLUŠENSTVO PRE MULTITOOL

	ø (mm)	materiál	TPI/ zrnitosť	použitie	označenie	Obj. č.	MOC s DPH
Odsávací adaptér pre multitool *****							
					TM3000C	199618-3	7,49 €
					TM30D	199630-3	12,59 €
					TM3010C	199624-8	9,99 €
					DTM41,DTM51	199627-2	12,39 €
					DTM52	191R02-6	14,09 €

Brúsny tanier *****							
	78	TC/HM	20	malta, lepidlo na obklady	TMA073	B-65062	21,39 €
	90	TC/HM	20	malta, lepidlo na obklady	TMA083	B-69799	18,79 €
	990	TC/HM	40	malta, lepidlo na obklady	TMA84	B-69808	18,79 €
	90	TC/HM	60	malta, lepidlo na obklady	TMA085	B-69814	18,79 €
	90	TC/HM	100	malta, lepidlo na obklady	TMA086	B-69820	18,79 €

Rezný a brúsny tanier *****							
	70	TC/HM	44	malta, lepidlo na obklady	TMA074	B-65078	37,89 €

Adaptér *****							
	adaptér pre príslušenstvo Fein					196271-6	6,69 €

Sady nástrojov **B-67496** **62,29 €** (MOC s DPH)

B-64923 / B-64989 / B-65028 / B-65115
4 ks/bal



Sady nástrojov **B-67480** **51,89 €** (MOC s DPH)

B-64799 / B-64814 / B-64870 / B-64923
4 ks/bal



Sady nástrojov **B-67505** **50,09 €** (MOC s DPH)

B-64799 / B-64820 / B-64858 / B-64955
4 ks/bal



Sady nástrojov **B-67511** **52,09 €** (MOC s DPH)

B-64799 / B-64814 / B-64870 / B-65115 x 2
5 ks/bal



Sada rezných nástrojov **B-64842-5** **61,09 €** (MOC s DPH)

TMA050 24 x 50 mm, 5 ks/bal.
vhodný na rezanie dreva







Sada rezných nástrojov **B-64870-5** **42,49 €** (MOC s DPH)

TMA053 35 x 50 mm, 5 ks/bal.
vhodný na rezanie dreva



Akumulátory
Odkladacie systémy
Vrtanie
Skrutkovanie
Brúsky
Pílenie
Frézovanie
Brúsenie
Klince / spony
Špeciálne stroje
Vysávanie
Fény/lampy
Záhada
Ručné náradie
Ostatné

DELENIE: PRÍSLUŠENSTVO PRE MULTITOOL

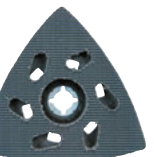
	rozměr (mm)	zrnitost	ks/bal.	Obj. č.	MOC s DPH
Drevo / Long Life *****					
 <p>Vhodné na brúsenie dreva, tvrdého dreva, drevotriesky, stavebného dreva alebo kovu</p>	93	60	10	P-33261	3,19 €
	93	80	10	P-33277	3,09 €
	93	100	10	P-33283	2,99 €
	93	120	10	P-33299	2,99 €
	93	180	10	P-33314	2,99 €
	93	240	10	P-33320	2,99 €
	93	60, 80, 100, 120, 180 (2 ks z každého)	10	B-21559	3,19 €
	Farba *****				
 <p>Vhodné na brúsenie farieb a lakov</p>	93	60	10	P-42690	3,09 €
	93	80	10	P-42709	3,09 €
	93	100	10	P-42715	2,99 €
	93	120	10	P-42721	2,99 €
	93	240	10	P-42759	2,99 €
	93	320	10	P-42765	2,89 €
	93	60,80,100,240,320 (2 ks z každého)	10	B-21674	2,99 €
	Kameň *****				
 <p>Vhodné na hrubé obrúsenie extrémne tvrdých materiálov napríklad kameňa alebo skla</p>	93	120	10	B-21749	3,09 €
	93	240	10	B-21755	2,99 €
	93	400	10	B-21761	2,99 €
	93	600	10	B-21777	2,99 €
	93	1200	10	B-21783	2,99 €
	93	120, 240, 400, 600, 1200 (2 ks z každého)	10	B-21733	2,99 €
	Fleece *****				
 <p>Vhodné na obrusovanie hrdzavých plôch alebo nečistôt z dreva</p>	93	100	1	B-21799	1,79 €
	93	280	1	B-21808	1,79 €
	93	bez brusiva	1	B-21814	1,79 €
Leštenie *****					
 <p>Vhodné na leštenie veľmi nečistých alebo poškriabaných povrchov.</p>	93	tvrdý	1	B-21820	1,89 €
Držiak brúsneho papiera *****					
	suchý zip	TMA078	1	B-65115	11,29 €

Rezanie (ponorné rezanie)

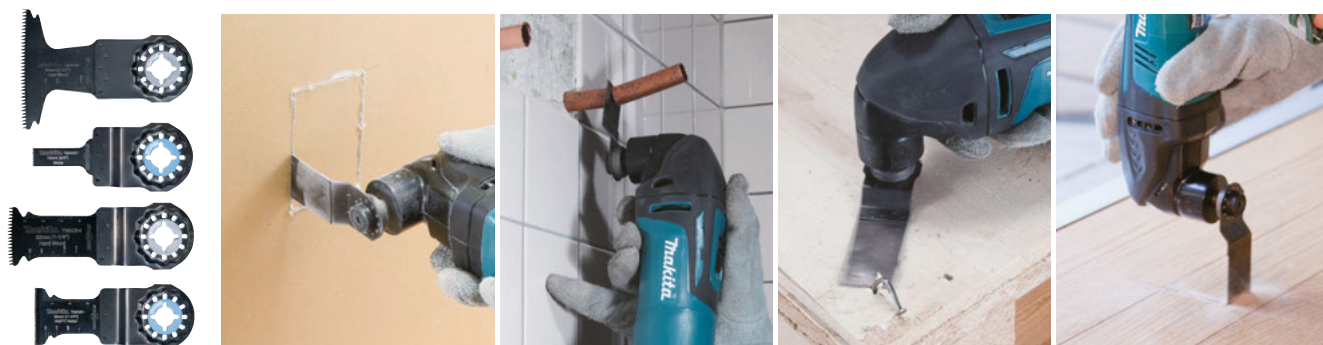

Pílenie

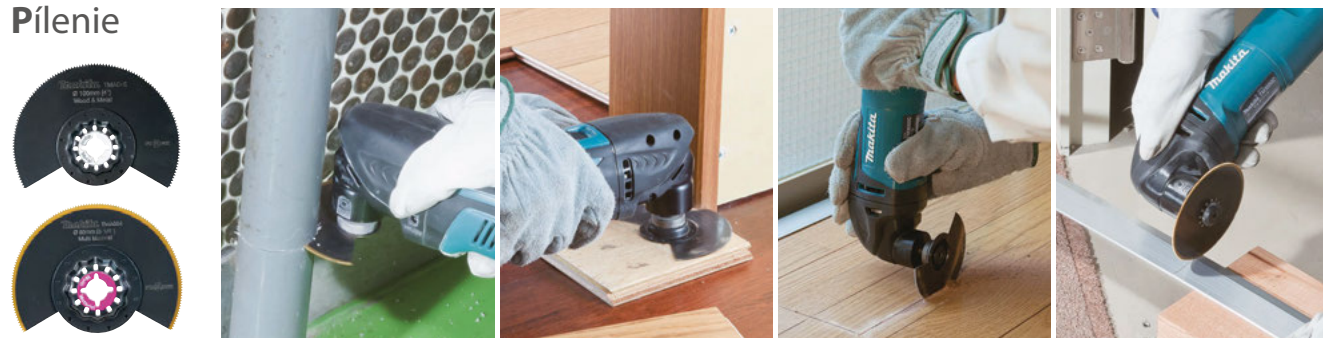

Brúsenie



Odstraňovanie škárovacej hmoty a rezanie dlaždíc



Škrabanie



Kompatibilné s modelmi		typ upnutia		
		STARLOCK	STARLOCK PLUS	STARLOCK MAX
typ upnutia	OIS kompatibilné stroje	✓	-	-
	STARLOCK MAX	✓	✓	✓

Vhodné najmä na drevo a kov

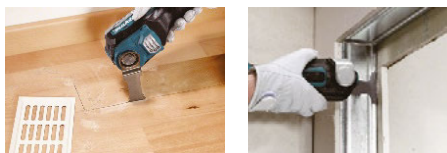

Ponorný pílový list v tvare oblúka 32

MAP001



Použitie: Vhodné pre presný ponorný rez, hlboký rez
Vhodné aj pre: epoxid, sklolaminát

rozmer (mm)	typ	ks/bal.	obj. č.	MOC s DPH
32 x 60	BiM, drevo a kov	1	B-66329	13,09 €

Ponorný pílový list v tvare oblúka 65

MAP002

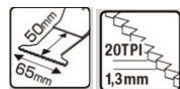

Použitie: Vhodné pre presný ponorný rez, hlboký rez
Další materiál: epoxid, sklolaminát

rozmer (mm)	typ	ks/bal.	obj. č.	MOC s DPH
65 x 50	BiM, drevo a kov	1	B-66335	16,29 €

Vhodné najmä na drevo



Ponorný pílový list v tvare oblúka 32

MAP003

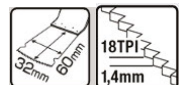

Použitie: Vhodné pre presný ponorný rez, hlboký rez
Vhodné aj pre: epoxid

rozmer (mm)	typ	ks/bal.	obj. č.	MOC s DPH
32 x 60	HCS, drevo	1	B-66341	10,09 €

Vhodné najmä na kovy



TC ponorný pílový list 32

MAP004



Použitie: Vhodné pre ponorný rez, hlboký rez
Vhodné aj pre: drevené materiály, epoxid, sklolaminát

rozmer (mm)	typ	ks/bal.	obj. č.	MOC s DPH
32 x 50	TC/HM, Metal	1	B-66357	22,69 €

TC ponorný pílový list 45

MAP005



Použitie: Vhodné pre ponorný rez, hlboký rez
Vhodné aj pre: drevené materiály, epoxid, sklolaminát

rozmer (mm)	typ	ks/bal.	obj. č.	MOC s DPH
45 x 50	TC/HM, Metal	1	B-66363	24,19 €

Vhodné najmä pre MultiMaterial



TC ponorný pílový list v tvare oblúka 32

MAP006



Použitie: Vhodné pre ponorný rez, hlboký rez
Vhodné aj pre: drevené materiály, sádrokartón, nežeľzné kovy, plech, nerez, mäkký klinec

rozmer (mm)	typ	ks/bal.	obj. č.	MOC s DPH
32 x 50	TC/HM, Multi Material	1	B-66379	24,19 €

TC ponorný pílový list v tvare oblúka 52

MAP007



Použitie: Vhodné pre ponorný rez, hlboký rez
Vhodné aj pre: drevené materiály, sádrokartón, nežeľzné kovy, plech, nerez, mäkký klinec

rozmer (mm)	typ	ks/bal.	obj. č.	MOC s DPH
52 x 50	TC/HM, Multi Material	1	B-66385	25,19 €

Vhodné najmä pre škárovcie hmoty



Ponorný pílový list v tvare oblúka 53

MAM008



Použitie: Vhodné pre presný a rýchly ponorný rez
Vhodné aj pre: drevené materiály, sádkokartón, neželezné kovy, mäkký klinec, epoxid, 1 nóż 2 práce (zápich a rezanie)

rozmer (mm)	typ	ks/bal.	obj. č.	MOC s DPH
53 x 40	TC/HM zrnitc	1	B-66391	18,19 €

STARLOCK MAX

Kompatibilné s modelmi		typ upnutia		
		STARLOCK	STARLOCK PLUS	STARLOCK MAX
typ upnutia	OIS kompatibilné stroje	✓	–	–
	STARLOCK MAX	✓	✓	✓

Vhodné najmä na drevo a kov



Ponorný pílový list v tvare oblúka 32

MAM001

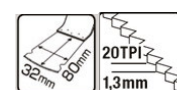

Použitie: Vhodné pre presný ponorný rez, hlboký rez
Vhodné aj pre: epoxid, sklolaminát

rozmer (mm)	typ	ks/bal.	obj. č.	MOC s DPH
32 x 80	BiM, drevo a	1	B-66400	13,69 €

Ponorný pílový list v tvare oblúka 52

MAM002

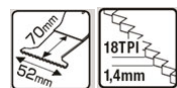

Použitie: Vhodné pre presný ponorný rez, hlboký rez
Vhodné aj pre: epoxid, sklolaminát

rozmer (mm)	typ	ks/bal.	obj. č.	MOC s DPH
52 x 70	BiM, drevo a	1	B-66416	14,79 €

Segmentový pílový kotúč 100

MAM003



Použitie: Vhodné pre rovné dlhé rezy, hlboké a široké rezy
Vhodné aj pre: epoxid, sklolaminát

rozmer (mm)	typ	ks/bal.	obj. č.	MOC s DPH
100	BiM, drevo a	1	B-66422	23,69 €

Vhodné najmä na drevo



Ponorný pílový list v tvare oblúka 32

MAM004

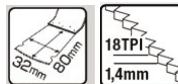

Použitie: Vhodné pre presné zapichovacie rezy, hlboké a rýchle rezy
Vhodné len pre drevo

rozmer (mm)	typ	ks/bal.	obj. č.	MOC s DPH
32 x 80	HCS, dre	1	B-66438	10,59 €

Vhodné najmä na kovy



TC ponorný pílový list 32

MAM005



Použitie: Vhodné pre ponorné, hlboké a rýchle rezy
Vhodné aj pre: epoxid, sklolaminát, drevené materiály, pórobeton

rozmer (mm)	typ	ks/bal.	obj. č.	MOC s DPH
32 x 70	TC/HM, ko	1	B-66444	23,69 €

Vhodné najmä pre MultiMaterial

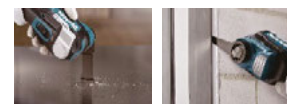

TC ponorný pílový list v tvare oblúka 32

MAM006



Použitie: Vhodné pre presné ponorné, hlboké a rýchle rezy
Vhodné aj pre: epoxid, sklolaminát, drevené materiály, pórobeton

rozmer (mm)	typ	ks/bal.	obj. č.	MOC s DPH
32 x 70	TC/HM, Multi I	1	B-66450	25,29 €

Ponorný pílový list

MAM007

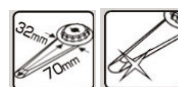

Použitie: na rezanie mäkkých spojov, tmelov na okná, izolačné materiály, kobercov, gummy, lepenky

rozmer (mm)	typ	ks/bal.	obj. č.	MOC s DPH
32 x 70	HCS, Multi M	1	B-66466	13,89 €

Ponorný pílový list

MAM008



Použitie: na rezanie mäkkých spojov, tmelov na okná, izolačné materiály, kobercov, gummy, lepenky

rozmer (mm)	typ	ks/bal.	obj. č.	MOC s DPH
32 x 55	HCS, Multi M	1	B-66472	6,69 €

Vhodné najmä pre škárované hmoty

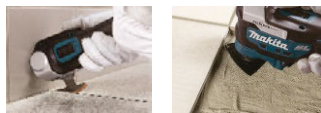

TC pílový kotúč 68

MAM009

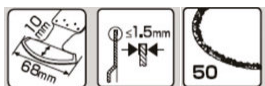

Použitie: Vhodné pre frézovanie škár na obkladačkách
Vhodné aj pre: epoxid, sádrokartón, sklolaminát

priemer (mm)	typ	ks/bal.	obj. č.	MOC s DPH
68	TC/HM grit #50	1	B-66494	28,89 €

TC pílový kotúč 68

MAM010

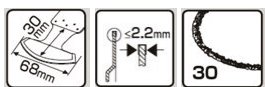

Použitie: Vhodné pre frézovanie škár na obkladačkách
Vhodné aj pre: epoxid, sádrokartón, sklolaminát

priemer (mm)	typ	ks/bal.	obj. č.	MOC s DPH
68	TC/HM grit #30	1	B-66503	28,89 €

Diamantový pílový kotúč 68

MAM011

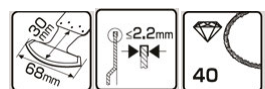

Použitie: Vhodný pre výrezy v mäkkých obkladačkách
Vhodné aj pre: epoxid, sádrokartón, sklolaminát

priemer (mm)	typ	ks/bal.	obj. č.	MOC s DPH
68	Diamond grit #40	1	B-66519	39,19 €

Diamantový pílový kotúč 68

MAM012

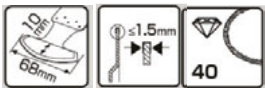

Použitie: Vhodný pre výrezy v mäkkých obkladačkách
Vhodné aj pre: epoxid, sádrokartón, sklolaminát

priemer (mm)	typ	ks/bal.	obj. č.	MOC s DPH
68	Diamond grit #40	1	B-66525	39,19 €

TC segmentový pílový kotúč 68

MAM013

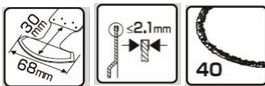

Použitie: Vhodné pre frézovanie škár na obkladačkách
Vhodné aj pre: epoxid, sádrokartón, sklolaminát

priemer (mm)	typ	ks/bal.	obj. č.	MOC s DPH
68	TC/HM grit #40	1	B-66531	23,09 €

TC segmentový pílový kotúč 100

MAM014

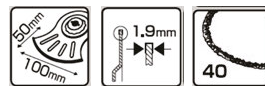

Použitie: Vhodné pre frézovanie škár na obkladačkách
Vhodné aj pre: epoxid, sklolaminát, drevené materiály

priemer (mm)	typ	ks/bal.	obj. č.	MOC s DPH
100	TC/HM grit #40	1	B-66547	27,69 €

TC brúsna doska 116

MAM015



Použitie: Vhodné pre frézovanie škár na obkladačkách
Vhodné aj pre: epoxid, sklolaminát, drevené materiály

priemer (mm)	typ	ks/bal.	obj. č.	MOC s DPH
116	TC/HM grit #20	1	B-66553	20,99 €

TC brúsna doska 116

MAM016

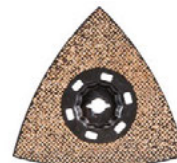
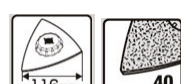

Použitie: Vhodné pre frézovanie škár na obkladačkách
Vhodné aj pre: epoxid, sklolaminát, drevené materiály

priemer (mm)	typ	ks/bal.	obj. č.	MOC s DPH
116	TC/HM grit #40	1	B-66569	20,99 €

TC brúsna doska 116

MAM017



Použitie: Vhodné na brúsenie dreva
Vhodné aj pre: drevené materiály

priemer (mm)	typ	ks/bal.	obj. č.	MOC s DPH
116	TC/HM grit #60	1	B-66575	20,99 €

TC brúsna doska 116

MAM018

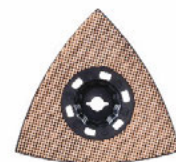

Použitie: Vhodné na brúsenie dreva
Vhodné aj pre: drevené materiály

priemer (mm)	typ	ks/bal.	obj. č.	MOC s DPH
116	TC/HM grit #100	1	B-66581	20,99 €

PRÍSLUŠENSTVO

▣ Brúsne kefy



Brúsne kefy



Typ kefy



Oceľový drôt s priemerom 0,3 mm
Ideálny na odstraňovanie hrdze a náterov.



Nylonová (#80)
Ideálna na odstraňovanie farieb z kovu, dreva a PVC.



Nylonová (#240)
Ideálna na povrchovú úpravu kovov, dreva a PVC.

Typ kefy



Miskovitá
Pre rovné plochy.



Kotúčová
Pre úzke miesta.



Štetcovitá
Pre úzke miesta.









Lopatková
Pre ošetrovanie povrchu dreva.

AA : odporúčané

Typ kefy			
	Oceľový drôt s priemerom 0,3 mm	Nylonová (#80)	Nylonová (#240)
Drevo 		AA	AA
PVC 		AA	AA
Metal 	AA	AA	AA
Opracovanie (kovový povrch)			 dobrúsené po nylonovej kefe (#80)

DELENIE: KEFY Z OCEĽOVÉHO DRÔTU

	Ø kefy (mm)	počet vretien	max. otáčky (min ⁻¹)	upínanie	vhodné pre uhl. brúsky (Ø mm)	Obj. č.	MOC s DPH
Oceľová drôtená kefa miskovitá - spleťaný drôt, Ø drôtu 0,5 mm *****							
	65	18	12500	M14	115 / 125 / 150	P-04488	13,19 €
	100	26	8500	M14	180 / 230	P-04472	24,19 €
Oceľová drôtená kefa kotúčová - spleťaný drôt, Ø drôtu 0,5 mm *****							
	100	18	12500	M14	180 / 230	P-04494	17,29 €
Mosadzná drôtená kefa miskovitá - vlnitý drôt, Ø drôtu 0,3 mm ***							
	60			M14	125 / 150	D-39746	3,69 €
	75			M14	125 / 150	D-39768	4,19 €
	90			M14	180 / 230	D-39780	5,49 €
	100			M14	180 / 230	D-39805	7,39 €
Oceľová drôtená kefa kotúčová - vlnitý drôt, Ø drôtu 0,3 mm ***							
	100			M14	180 / 230	D-39827	4,69 €
	115			M14	180 / 230	D-39849	5,49 €
Oceľová drôtená kefa miskovitá - spleťaný drôt, Ø drôtu 0,5 mm ***							
	100			M14	180 / 230	D-39861	5,09 €
	115			M14	180 / 230	D-39883	6,39 €
Oceľová drôtená kefa miskovitá - vlnitý drôt, Ø drôtu 0,3 mm ***							
	60			M14	125 / 150	D-24072	3,89 €
	75			M14	125 / 150	D-24094	4,89 €
	100			M14	180 / 230	D-29284	6,79 €
Oceľová drôtená kefa miskovitá - spleťaný drôt, Ø drôtu 0,5 mm ***							
	60			M14	125 / 150	D-24119	6,29 €
	75			M14	125 / 150	D-24131	6,89 €
Oceľová drôtená kefa miskovitá - spleťaný drôt, Ø drôtu 0,5 mm ***							
	60			M14	125 / 150	D-24153	6,79 €
	100			M14	180 / 230	D-29290	11,99 €

Oblasť využitia kief z oceľového drôtu: odstraňovanie lakov, okovín, hrdze, trosky, odstraňovanie zvyškov betónu a tmelov/stierky zahľadzovanie a začisťovanie zvarov, príprava kovových povrchov pred lakovaním. Mimoriadne prednosti: vysoká tuhosť drôtených vretien, vďaka tomu majú kefy vysoký úberový výkon, húževnatosť, veľmi vysoká pevnosť v tahu umožňuje vysoké otáčky. Kuželovitý tvar kief uľahčuje kefovanie na ťažko prístupných miestach (vnútorné hrany, ryhy, drážky).

DELENIE: KEFY Z OCEĽOVÉHO DRÔTU

Ø kefy (mm)	Počet vretien	max. otáčiky (min ⁻¹)	upínanie	vhodné pre uhl. brúsky (Ø mm)	Obj. č.	MOC s DPH
Oceľová drôtená kefa kotúčová - spletaný drôt, Ø drôtu 0,5 mm						***
	100		M14	125 – 230	D-29555	6,19 €
	115		M14	125 – 230	D-29561	7,29 €
	125		M14	125 – 230	D-29577	8,89 €
	150		M14	180	D-45761	8,69 €
	175		M14	230	D-45777	12,19 €

Ø kefy (mm)	Počet vretien	max. otáčiky (min ⁻¹)	upínanie	vhodné pre uhl. brúsky (Ø mm)	Obj. č.	MOC s DPH
Oceľová drôtená kefa štetcovitá - vlnitý drôt, Ø drôtu 0,3 mm						***
	12 x 6				D-40004	1,59 €
	19 x 6				D-40010	1,69 €
	25 x 6				D-40026	2,29 €
	30 x 6				D-40032	2,09 €
	12	4.500	1/4"		D-73704	1,59 €
	19	4.500	1/4"		D-73710	1,79 €
	24	4.500	1/4"		D-73726	2,09 €
	28	4.500	1/4"		D-73732	2,39 €

Ø kefy (mm)	Počet vretien	max. otáčiky (min ⁻¹)	upínanie	vhodné pre uhl. brúsky (Ø mm)	Obj. č.	MOC s DPH
Oceľová drôtená kefa miskovitá - vlnitý drôt, Ø drôtu 0,3 mm						***
	38 x 6				D-39908	1,89 €
	50 x 6				D-39914	2,09 €
	63 x 6				D-39920	2,29 €
	75 x 6				D-39936	2,69 €
	80 x 6				D-39942	2,79 €
	38	4.500	1/4"		D-73601	1,69 €
	50	4.500	1/4"		D-73617	1,89 €
	63	4.500	1/4"		D-73623	2,09 €
	70	4.500	1/4"		D-73639	2,29 €
	80	4.500	1/4"		D-73645	2,79 €

Oblasti využitia kief z oceľového drôtu: odstraňovanie lakov, okovín, hrdze, trosky, odstraňovanie zvyškov betónu a tmelov/stierky zahladzovanie a začisťovanie zvarov, príprava kovových povrchov pred lakovaním.

Mimoriadne prednosti: vysoká tuhosť drôtených vretien, vďaka tomu majú kefy vysoký úberový výkon húževnaté, veľmi vysoká pevnosť v ťahu umožňujú vysoké otáčiky kužeľovitý tvar kefy uľahčuje kefovanie na ťažko prístupných miestach (vnútorné hrany, ryhy, drážky)

DELENIE: KEFY Z OCEĽOVÉHO / NEREZOVÉHO DRÔTU S UPÍNANÍM 1/4 "

	Ø kefy (mm)	Počet vretien	max. otáčiky (min ⁻¹)	upínanie	vhodné pre uhl. brúsky (Ø mm)	Obj. č.	MOC s DPH
Oceľová drôtená kefa miskovitá - vlnitý drôt, Ø drôtu 0,3 mm							***
	38		4.500	1/4 "		D-76417	1,79 €
	50		4.500	1/4 "		D-76423	2,09 €
	65		4.500	1/4 "		D-76439	2,29 €
	75		4.500	1/4 "		D-76445	2,59 €
	80		4.500	1/4 "		D-76451	2,99 €
Oceľová drôtená kefa kotúčová - vlnitý drôt, Ø drôtu 0,3 mm							
	38		4.500	1/4 "		D-76467	1,79 €
	50		4.500	1/4 "		D-76473	1,79 €
	65		4.500	1/4 "		D-76489	2,09 €
	75		4.500	1/4 "		D-76495	2,29 €
	100		4.500	1/4 "		D-76504	2,59 €
Oceľová drôtená kefa štetcovitá - vlnitý drôt, Ø drôtu 0,3 mm							
	12		4.500	1/4 "		D-76510	1,69 €
	19		4.500	1/4 "		D-76526	1,99 €
	24		4.500	1/4 "		D-76532	2,29 €
	28		4.500	1/4 "		D-76548	2,49 €
Nerezová drôtená kefa miskovitá - vlnitý drôt, Ø drôtu 0,3 mm							
	38		4.500	1/4 "		D-76554	2,49 €
	50		4.500	1/4 "		D-76560	2,89 €
	65		4.500	1/4 "		D-76576	3,09 €
	75		4.500	1/4 "		D-76582	3,59 €
	80		4.500	1/4 "		D-76598	4,19 €
Nerezová drôtená kefa kotúčová - vlnitý drôt, Ø drôtu 0,3 mm							
	38		4.500	1/4 "		D-76607	2,39 €
	50		4.500	1/4 "		D-76613	2,49 €
	65		4.500	1/4 "		D-76629	2,89 €
	75		4.500	1/4 "		D-76635	3,09 €
	100		4.500	1/4 "		D-76641	3,59 €
Nerezová drôtená kefa štetcovitá - vlnitý drôt, Ø drôtu 0,3 mm							
	12		4.500	1/4 "		D-76657	2,39 €
	19		4.500	1/4 "		D-76663	2,69 €
	24		4.500	1/4 "		D-76679	3,09 €
	28		4.500	1/4 "		D-76685	3,49 €

Akumulátory
 Odkladacie systémy
 Vrtanie
 Skrutkovanie
 Brúsky
 Pílenie
 Frézovanie
 Brúsenie
 Špeciálne stroje
 Klince / spony
 Vysávanie
 Fény/lampy
 Záhrada
 Ručné náradie
 Ostatné

DELENIE: KEFY Z OCEĽOVÉHO DRÔTU

Ø kefy (mm)	Počet vretien	max. otáčiky (min ⁻¹)	upínanie	vhodné pre uhl. brusky (Ø mm)	Obj. č.	MOC s DPH
-------------	---------------	-----------------------------------	----------	-------------------------------	---------	-----------

Oceľová drôtená kefa kotúčová - vlnitý drôt, Ø drôtu 0,3 mm



38 x 6					D-39958	1,79 €
50 x 6					D-39964	1,79 €
63 x 6					D-39970	1,99 €
75 x 6					D-39986	2,39 €
100 x 6					D-39992	2,59 €
38		4.500	1/4"		D-73651	1,59 €
50		4.500	1/4"		D-73667	1,69 €
63		4.500	1/4"		D-73673	1,89 €
75		4.500	1/4"		D-73689	2,19 €
100		4.500	1/4"		D-73695	2,29 €

Oceľová drôtená kefa miskovitá - spletaný drôt, Ø drôtu 0,5 mm



63		4.500	Ø6		D-73798	4,69 €
75		4.500	Ø6		D-73807	5,19 €

Oceľová drôtená kefa kotúčová - spletaný drôt, Ø drôtu 0,5 mm







75		4.500	Ø6		D-73813	4,69 €
100		4.500	Ø6		D-73829	4,69 €

Oceľová drôtená kefa štetcovitá - spletaný drôt, Ø drôtu 0,5 mm



12		4.500	Ø6		D-73835	2,29 €
19		4.500	Ø6		D-73841	2,99 €
24		4.500	Ø6		D-73857	3,49 €
28		4.500	Ø6		D-73863	4,59 €

DELENIE: KEFY NYLÓNOVÉ PRE VŔTAČKY

	Ø kefy (mm)	Zrnitosť	hrúbka drôtu (mm)	Obj. č.	MOC s DPH	
Miskovitá *****						
	75	jemný (#240)	6	D-45559	6,39 €	
	63	jemný (#240)	6	D-45543	5,49 €	
	50	jemný (#240)	6	D-45537	3,49 €	
	75	hrubý (#80)	6	D-45521	6,49 €	
	63	hrubý (#80)	6	D-45515	5,09 €	
	50	hrubý (#80)	6	D-45509	3,89 €	
Kotúčová *****						
	38	jemný (#240)	6	D-45618	2,99 €	
	50	jemný (#240)	6	D-45624	3,79 €	
	63	jemný (#240)	6	D-45630	4,19 €	
	75	jemný (#240)	6	D-45646	4,89 €	
	100	jemný (#240)	6	D-45652	6,09 €	
	38	hrubý (#80)	6	D-45565	cena na vyžiadanie	
	50	hrubý (#80)	6	D-45571	3,49 €	
	75	hrubý (#80)	6	D-45593	5,69 €	
	100	hrubý (#80)	6	D-45602	6,09 €	
	Štetcovitá *****					
	12	jemný (#240)	6	D-45705	2,29 €	
	19	jemný (#240)	6	D-45711	2,89 €	
	25	jemný (#240)	6	D-45727	3,19 €	
	30	jemný (#240)	6	D-45733	cena na vyžiadanie	
	12	hrubý (#80)	6	D-45668	cena na vyžiadanie	
	19	hrubý (#80)	6	D-45674	2,89 €	
	30	hrubý (#80)	6	D-45696	4,89 €	
	Lopatková *****					
		100	jemný	6	D-45755	7,59 €
100		hrubý	6	D-45749	6,59 €	

Akumulátory
 Odkladacie systémy
 Vrtanie
 Skrutkovanie
 Brúsky
 Pílenie
 Frézovanie
 Brúsenie
 Klince / spony
 Špeciálne stroje
 Vysávanie
 Fény/lampy
 Záhraďa
 Ručné náradie
 Ostatné

DELENIE: PRÍSLUŠENSTVO PRE UHLOVÉ BRÚSKY

upínanie	popis	vhodné pre uhl. brúsky (ø mm)	Obj. č.	MOC s DPH
Príruby, matice *****				
				
M14	superpríruba	115 – 230	192227-7	13,29 €
M14	supermatica	115 – 230	196297-8	20,79 €
M14	špeciálna príruha EZYNUIT	180 – 230	195354-9	62,79 €
M14	upínacia príruha	115 – 230	224415-9	1,80 €
M14	príruba	115 – 230	224447-6	3,19 €
M14	prírubová matica	115 – 150	224554-5	2,59 €
M14	prírubová matica	180 – 230	224543-0	1,48 €

Rukoväte *****				
				
M8	štandard		153489-2	1,09 €
M14	štandard		152539-0	3,19 €
M8	antivibračná		194514-0	15,59 €
M8	štandard	DDA450, DGA504, DGA506, DGA511, DGA513, DGA514, DGA517, DGA518, DGA519, DGA520, DGA521	158237-4	2,89 €
M14	antivibračná		162264-5	12,39 €
M14	sada na uchytenie rukoväti	GA7020/S, GA7030/S, GA7040S, GA9020/S, GA9030/S, GA9040S	194684-5	15,09 €

Klíúče *****				
				
	kľúè kolíkový	PC5000C, PC5001C, PC5010C	782426-5	3,09 €
	kľúè kolíkový	115 – 150	782423-1	1,69 €
	kľúè kolíkový	180 – 230	197610-3	2,39 €
	kľúè kolíkový	PC1100	782401-1	1,29 €
	povoľovacia matica	180 – 230	194305-9	48,89 €

Vak na prach *****				
				
	PC5000C, PC5001C		122853-8	5,79 €

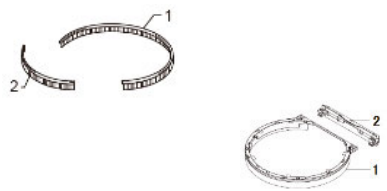

Odsávacie adaptéry pre uhlové brúsky *****				
				
brúsenie	C	115 – 125 mm	127147-6	56,69 €
brúsenie	C	180 mm	195385-8	69,99 €
brúsenie	C	115 – 125 mm X-LOCK	191F81-2	46,39 €
rezanie	A	230 mm	194044-1	232,29 €
rezanie	A	115 – 125 mm	193794-5	150,79 €
rezanie	D	115 – 125 mm	196845-3	98,69 €
rezanie	E	230 mm	198440-5	185,59 €
rezanie	D	115 – 125 mm	191G06-2	162,29 €

Prídavný kryt pre uhlové brúsky *****				
				
	vhodný pre kryt ø 115 mm, 123144-0		199709-0	8,79 €
	vhodný pre kryt ø 125 mm, 123145-8		199710-5	12,19 €

Kefky pre brúsne kryty				
				
	1	195385-8	743334-5	19,29 €
	2	195385-8	743335-3	8,89 €
	1	127147-6	743332-9	18,76 €
	2	127147-6	743333-7	15,54 €
	1	PC5000 / 5001	443144-7	5,64 €
	2	PC5000 / 5001	443145-5	3,13 €
	1	DSL800	140J85-5	49,36 €
	2	DSL800	140J86-3	12,61 €
		DSL801	743127-0	42,89 €

DELENIE: PRÍSLUŠENSTVO PRE UHLOVÉ BRÚSKY

	model	Obj. č.	MOC s DPH	Obj. č.	MOC s DPH	Obj. č.	MOC s DPH	
Kryty kotúčov								

 <p>1 – otvorený kryt s výmenou na kľúč</p>	9557HN/HNR	123098-1	7,70 €	123144-0	10,01 €	122642-1	5,12 €	
	9558HN/HNR							
	9562CR	123099-9	8,24 €	135108-2	6,44 €	122911-0	9,44 €	
	9562CVR							
	9564H	123098-1	7,70 €	123144-0	10,01 €	122910-2	7,81 €	
	9565CR							
	9565CVR	123099-9	8,24 €	135108-2	6,44 €	122911-0	9,44 €	
	9565H							
	9565PCV							
	9566CR	135192-7	6,78 €	123146-6	12,49 €	165744-0	14,09 €	
 <p>2 – otvorený kryt s beznástrojovou výmenou</p>	BGA/DGA450	123098-1	7,70 €	123144-0	10,01 €	122910-2	7,81 €	
	BGA/DGA452							
	DGA504	123099-9	8,24 €	123145-8	11,74 €	122911-0	9,44 €	
	DGA506							
	DGA519				347618-9	7,39 €	162708-5	10,49 €
	GA5080R							
	GA4530							
	GA4530R							
	GA4540							
	GA4540C01	123098-1	7,70 €	123144-0	10,01 €	122910-2	7,81 €	
 <p>3 – zatvorený kryt s beznástrojovou výmenou</p>	GA4540R							
	GA4541C01							
	GA4541R							
	GA4541X01							
	GA5021	123099-9	8,24 €	135108-2	6,44 €	122911-0	9,44 €	
	GA5021C							
	GA5030	123099-9	8,24 €	123145-8	11,74 €	122911-0	9,44 €	
	GA5030R							
	GA5040							
	GA5040C01	123099-9	8,24 €	123145-8	11,74 €	122911-0	9,44 €	
	GA5040R							
	GA5041C01							
	GA5041R							
	GA5041X01							
	GA6021	135192-7	6,78 €	123146-6	12,49 €	165744-0	14,09 €	
	GA6021C							
	GA6040C01							
	GA7010C							
	GA7020							
	GA7020F							
	GA7020RF	122889-7	10,37 €	122846-5	9,88 €	122914-4	15,96 €	
	GA7030RF01							
	GA7040RF01							
	GA7060R							
	GA7061R							
	GA9010C							
	GA9020							
	GA9020F							
	GA9020RF							
	GA9020RFK							
	GA9030							
	GA9030R							
	GA9030RF01	122891-0	16,48 €	122847-3	19,69 €	122913-6	22,56 €	
	GA9030X01							
	GA9040R							
	GA9040RF01							
	GA9050							
	GA9050R							
	GA9060R							
	GA9061R							
	GA9062R							
	GA9063R							
	GA005G							
	GA013G							
	GA023G							
	GA026G			347480-2	7,43 €			
	GA029G							
	GA032G							
	GA5050R							
	GA5051R							

Akumulátory
 Odkladacie systémy
 Vrtanie
 Skrutkovanie
 Brúsky
 Pílenie
 Frézovanie
 Brúsenie
 Špeciálne stroje
 Klnce / spony
 Vysávanie
 Fény/lampy
 Záhrada
 Ručné náradie
 Ostatné

PRÍSLUŠENSTVO

▣ Delenie



Priemer



Počet zubov



Zárez



Hrúbka



Sklon



Ring



Pozdĺžny rez



Priečny rez



Vložený hrot



Silent



M-Force



Rýchly rez



Čistý rez



Extra čistý rez



Coated



Heavy duty



Dlhá životnosť



PCD tip



Sharp

Tvary zubov



ATB
Striedané vrchné skosenie zubov vhodný pre drevo a hliník.

ATBR
Pridané ploché zuby do ATB pre ľahké priame rezanie

Hi-ATB
Striedané vrchné skosenie zubov s väčším horným uhlom skosenia.

ATAF
Rezanie dreva, preglejky, dyhy, sololitu, drevovláknitých dosiek a drevotriekových dosiek.

ATAFR
Pridanie plochých zubov do ATAF vhodné pre rovný rez.

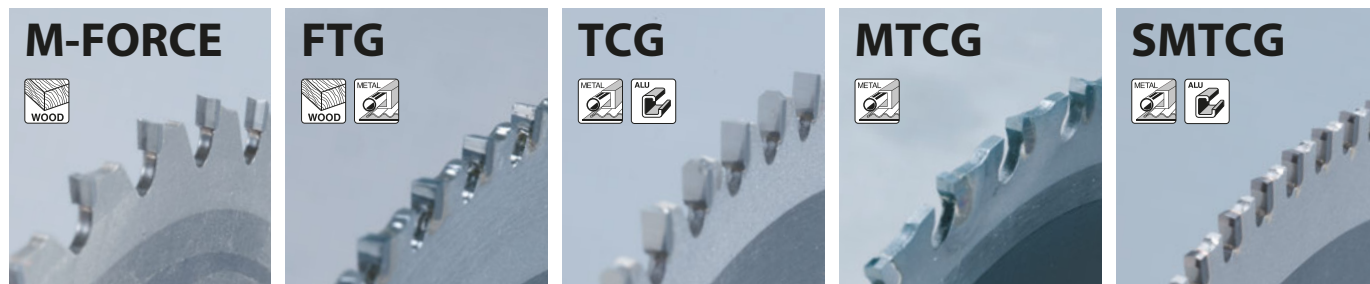
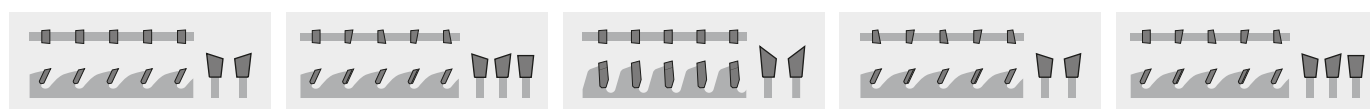

M-FORCE
Predné a vrchné časti zubov tvarujú symetrickú V drážku so znakmi ATB a FTG.

FTG
Ploché zuby, umožňujú ľahké priame rezanie a špičky sú zriedka odštiepené. Na rezanie dreva pozdĺž vlákna a rezanie tenkého kovu.

TCG
Trapézové a ploché zuby sa striedajú, Umožňuje ľahké priame rezanie a špičky sú zriedka odštiepené.

MTCG
Ploché zuby so striedavým skosením. Menej rezného odporu ako ploché zuby.

SMTCG
Kontrast k MTCG, asymetrické dve skosenia na hornej časti zuba, ktoré vytvárajú ostré hrany. Umožňuje ľahké zahryznutie do materiálov.

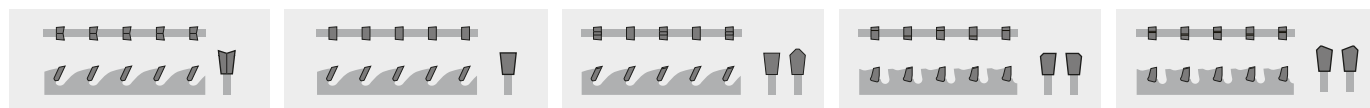

Technical term

<p>Laser Slit</p>	<p>Coated</p>	<p>Tip Embedded</p>	<p>P.C.D Tip</p>
<p>Systém tlmenia vibrácií Laserom vyrezané telo vyplnené živickou sloty pre hladšie a tichšie strihy.</p>	<p>PTFE (polytetrafluóretylén) potiahnutý kotúč pre zníženie odporu.</p>	<p>Vložený zub zvyšuje tvrdosť tela zubu od špičky.</p>	<p>PCD (polykryštalický diamant) hrot má extrémnu tvrdosť a odolnosť proti opotrebovaniu. Kotúč s hrotom PCD je najlepšou voľbou pre dlhodobé rezanie vláknocementovej dosky.</p>

Pílové kotúče



Sortiment príslušenstva Makita je vyladenou zmesou zloženou z preverených výrobkov a nápaditých inovácií, dôkladne vybraných tak, aby vyhovovali náročným potrebám profesionálnych užívateľov.

I keď je príslušenstvo Makita konštruované obzvlášť pre použitie s kvalitným náradím firmy Makita, väčšina z nich rovnako účinne rozširuje možnosti pri práci s náradím iných značiek.

Sortiment TCT pílových kotúčov

Komplexný sortiment TCT pílových kotúčov, ktorých konštrukcia vyhovuje pílam od firmy Makita i mnoho iných výrobcov. Vysoko kvalitnými pílovými kotúčmi firmy Makita, vyrobenými z tej najlepšej oceli podľa najprísnejších noriem, sa spoľahlivo prevádzkajú veľmi presné rezy. Každý zub má perfektne nabrúsené ostrie, ktoré znižuje množstvo malých triesok, čím zaisťuje ostrejšiu a presnejšiu hranu rezu.

Sortiment zahŕňa 5 rôznych typov pílových kotúčov pre ručné a stacionárne náradie.

Makita vyrába vysoko kvalitné príslušenstvo, ktoré v kombinácii s akýmkoľvek profesionálnym náradím vytvorí účinné a spoľahlivé riešenie pre každú prácu.

Mforce sú kotúče s revolučne vyvinutou konštrukciou zubu a dvojitémi zubmi pre rýchlejší a čistejší rez.

Makforce je komplexná rada kvalitne vyrobených ručných pílových kotúčov určených pre široké spektrum aplikácií. Majú vysokokvalitné špičky z karbidu wolframu a predĺženú životnosť.

Makblade Plus sú prvotriedne kotúče pre pokosové a stolné píly so špeciálnou konštrukciou zaručujúcou minimálne vibrácie a tichý chod.

Makblade predstavuje radu kotúčov pre pokosové a akumulátorové píly zahŕňajúce všetky obľúbené značky a modely. Kombinujú v sebe čistý presný rez a dlhú životnosť.

Špeciálne kotúče pre zvláštne aplikácie, stroje alebo materiály. Špeciálne konštruované zuby pre rezanie klinčov a „hřč“, hliníku a oceli alebo pre akumulátorové píly.

Ako čítať kódy výrobkov makita

Typ rezu	Priemer listu Ø mm	Vrtanie Ø mm
C = Hrubý M = Stredný F = Čistý XF = Extra čistý		A = 10 mm B = 15 mm C = 15,88 mm D = 16 mm E = 20 mm F = 25,4 mm G = 30 mm
C	X	230
S	2	24
C	2	24
G	2	24
L	2	24
Typ pílového kotúča MS = Pokosová píla CS = Okružná píla TS = Stolná píla CMS = Akku pokosová píla CC = Akku okružná píla BSS = BSS610 Li-ion CSP = ponorná okružná píla MCS = Píla na kov	Špeciálny kotúč X = Mforce E = zub so zapustenou špičkou A = hliník	Počet zubov Zvláštne vlastnosti L = Laserová štrbina a tichý

PRÍKLADY:

MSXF305100GL: pokosová píla – veľmi jemný rez – Ø 305 mm – 100 zubov – vrtanie 30 mm – laserová štrbina a tichý chod

CCM15024A: akku kotúčová píla – stredný rez – Ø 150mm – 24 zubov – vrtanie 10 mm

TSA20064G: stolná píla – na hliník – Ø 200 mm – 64 zubov – vrtanie 30 mm

DELENIE:



Funkcia

Ostrý horný uhol

 Vám umožní jemný rez povrchu s malým odporom

Zakrivené telo

 Umožňuje vynikajúci odvod triesok

Zoštíhlený krčok zuba

 Znížením odporu pri rezaní predlžuje výdrž batérií

Viac rezov na jedno nabitie



Rýchly rez



Dlhšia životnosť

Počet rezov na 1 nabitie

Hrúbka kotúča: 1,6 mm



165mm x 48T

Hrúbka kotúča: 1,0 mm



165mm x 50T

EFFICUT

100

**× 2,4
viac**

240

Výsledky skúšky závisia vo veľkej miere od tvrdosti drevených materiálov atď.

Ø kotúča (mm)	ID kód	hrúbka rezu (mm)	vrtanie (mm)	počet zubov	hrúbka kotúča (mm)	uhol zuby	tvár zuby	max. otáčky (min ⁻¹)	materiál	Obj. č.	MOC s DPH

165	CCM16525E	1,4	20	25	1	23°	ATAFR	9250	drevo	B-62985	34,89 €
165	CCXF16556EL	1,45	20	56	1	23°	ATAFR	9250	drevo, mdf, laminát	B-57336	65,99 €
165	CMSF16560E	1,85	20	60	1,35	10°	ATAFR	9250	drevo	B-69858	51,39 €
185	CCM18524G	1,45	30	24	1	23°	ATAFR	8250	drevo	E-08676	28,29 €
190	CCM19024G	1,45	30	24	1	23°	ATAFR	8040	drevo	B-64185	29,99 €
190	CCF19045G	1,45	30	45	1	23°	ATAFR	8250	drevo	B-68638	39,89 €
190	CMSC19025E	1,85	20	20	1,35	10°	ATBR	8040	drevo	E-11140	37,89 €
190	CMSM19045E	1,85	20	45	1,35	10°	ATBR	8040	drevo	E-11156	56,49 €
190	CMSF19060E	1,85	20	60	1,35	10°	ATBR	8040	drevo	E-11162	61,69 €
216	CMSM21645G	2	30	45	1,5	10°	ATAFR	7070	drevo	E-06971	53,39 €
216	CMSF21660G	2	30	60	1,5	10°	ATABR	7070	drevo	E-08888	58,99 €
216	CMSXF21680G	2	30	80	1,5	10°	ATABR	7070	drevo	E-08894	72,89 €
235	CCM23524G	2,2	30	24	1,5	20°	ATBR	6500	drevo	E-01915	42,59 €
260	CMSM26045G	2,15	30	45	1,65	10°	ATBR	5870	drevo	B-64624	55,39 €
260	CMSF26060G	2,15	30	60	1,65	10°	ATBR	5870	drevo	B-67234	61,69 €
260	CMSXF26080G	2,15	30	80	1,65	10°	ATBR	5870	drevo	B-67240	74,99 €
305	CMSM30560G	2,15	30	60	1,65	10°	ATBR	5000	drevo	B-67256	78,69 €
305	CMSF30580G	2,15	30	80	1,65	10°	ATBR	5000	drevo	B-67262	89,39 €
305	CMSXF305100G	2,15	30	100	1,65	10°	ATBR	5000	drevo	B-67278	104,09 €

DELENIE: PÍLOVÉ KOTUČE NA KOV

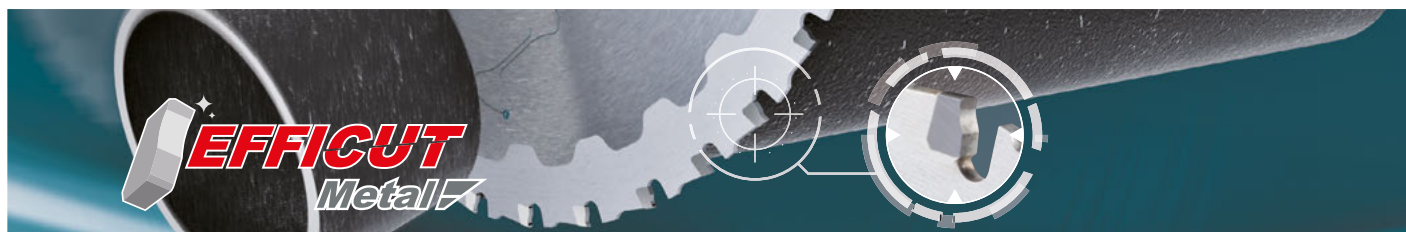

Funkcia

Tvrde, odolné voči ulomeniu

×
 Špeciálny dizajn špičky čepele zvyšuje účinnosť a životnosť.

Lahký odvod pilín

×
 Vynikajúci pri priamom rezaní

Zataženie špičiek kotúčov je možné efektívne rozložiť, aby sa potlačilo kolísanie pílového kotúča, čo zaisťuje rovnomerné priame rezanie a zvyšuje odolnosť proti zlomeniu hrotu.

Počet rezov na 1 nabitie

Hrúbka kotúča: 1,2 mm
150mm x 32T

Hrúbka kotúča: 0,95 mm
150mm x 33T
EFFICUT Metal

100

× 1,6 viac

160

Model: DCS553 (BL1860B)
Materiál: rúrka z uhlíkovej ocele (priemer: 31 mm / hrúbka: 3 mm)

Viac rezov na jedno nabitie

Rýchly rez

Dlhšia životnosť

Ø kotúča (mm)	ID kód	hrúbka rezu (mm)	vrtanie (mm)	počet zubov	hrúbka kotúča (mm)	uhol zubu	tvar zubu	max. otáčky (min ⁻¹)	materiál	Obj. č.	MOC s DPH
---------------	--------	------------------	--------------	-------------	--------------------	-----------	-----------	----------------------------------	----------	---------	-----------

EFFICUT na kov



136	MCCS13630E	1,1	20	30	0,95	0°	SMTCG	4.500	železo	B-69266	51,09 €
136	MCCS13645E	1,1	20	45	0,95	0°	SMTCG	4.500	nerez	B-69272	62,09 €
150	MCCS15033E	1,1	20	33	0,95	0°	SMTCG	4.680	železo	B-69288	52,19 €
150	MCCS15048E	1,1	20	48	0,95	0°	SMTCG	4.680	nerez	B-69331	62,09 €
185	MCCS18560GL	1,4	30	60	1,2	0°	SMTCG	5.800	kov/nerez	E-12843	106,39 €
185	MCCS18545GL	1,4	30	45	1,2	0°	SMTCG	5.800	kov	E-12859	87,19 €
305	MCS3063FL	2	25,4	63	2	0°	SMTCG	2.000	kov	E-12049	192,19 €

EFFICUT na hliník



165	CMSA16554EL	1,5	20	54	1,15	-3°	SMTCG	9.250	Hliník	E-16760	76,29 €
216	CMSA21663GL	1,85	30	63	1,5	0°	SMTCG	7.070	Hliník	E-16916	93,89 €

Špeciálne kotúče na kovy pre aku píly DCS550/551/552/553



150		1,5	20	32	1,2	0°	MTCG	4680	kov	B-46296	32,79 €
150	MCCS15052E	1,4	20	52	1,1	-15°	ATB	4680	tenký plech	B-47167	61,19 €
150	CCM8520B	1,6	20	52	1,0	0°	ATB	4680	hliník	B-47020	cena na vyžiadanie

Špeciálne pílové kotúče na kov a nehrdzavejúcu oceľ



136	MCS13656E	1,5	20	56	1,5	-5°		3 600	nerez	B-23086	64,99 €
185	MCSF18564GL	1,6	30	64	1,3	0°		5 800	nerez	B-31669	94,39 €
305	MCS305100F	2,4	25,4	100	1,5	-5°		2 000	nerez	B-23123	280,99 €

Frézovacie kotúče pre CA5000



118		14	20	6	6,0	5°	TCG		frézovací kotúč na hliník pre 90° ohyb materiálu.	B-48832	193,09 €
118		18	20	6	6,0	5°	TCG		frézovací kotúč na hliník pre 135° ohyb materiálu.	B-48860	213,19 €

Pílové kotúče EFFICUT určené pre pílenie WPC dosiek



165	CCF16540EL	1,5	20	40	1	15°	ATAFR	9.250	WPC dosky	E-12158	41,99 €
190	CMSF19050EL	1,85	20	50	1,35	8°	ATAFR	8.040	WPC dosky	E-12186	59,59 €
216	CMSF21660GL	2	30	60	1,5	8°	ATAFR	7070	WPC dosky	E-12192	77,29 €
260	CMSF26075GL	2,15	30	75	1,65	8°	ATAFR	5.870	WPC dosky	E-12201	77,49 €

Sortiment kotúčov na rezanie nehrdzavejúcej ocele od spoločnosti Makita je navrhnutý na čistejšie a rýchlejšie rezanie.

Špeciálne vyrobený karbid v kombinácii s jedinečným dizajnom hrotu odoláva poškodeniu pri náraze a vydrží dlhšie, kotúče Makita vydržia až 30-krát viac ako štandardné kotúče.

- Špeciálne tvarované špičky z tvrdokovu precízne brúsené pre rýchle čisté rezanie.
- Nízke iskrenie a minimálna tvorba prachu.
- Chladné rezy s okrajmi bez otrepu.

DELENIE: PÍLOVÉ KOTUČE

Ø kotúča (mm)	ID kód	hrúbka zuby (mm)	vrtanie (mm)	počet zubov	hrúbka kotúča (mm)	uhol zuby	Ø krúžku (mm)	rez priechny	rez pozdĺžny	max. otáčky (min ⁻¹)	materiál	Obj. č.	MOC s DPH
Pre kotúčové píly													

165	CSCX16510E	2	20	10	1,2	15°		•	•	9 250	drevo	B-07886	19,49 €
165	CSCX16510G	2	30	10	1,2	15°		•	•	9 250	drevo	B-07892	19,19 €
165	CSCX16516E	2	20	16	1,2	15°		•	•	9 250	drevo	B-31930	24,09 €
165	CSCX16524E	2	20	24	1,2	15°		•	•	9 250	drevo	B-32007	25,59 €
170	CSCX17016G	2	30	16	1,2	15°	15,88	•	•	8 980	drevo	B-07917	19,89 €
170	CSMX17024G	2	30	24	1,2	15°	15,88	•	•	8 980	drevo	B-08012	20,69 €
180	CSCX18016E	2	20	16	1,2	15°		•	•	8 480	drevo	B-07923	19,39 €
180	CSCX18016G	2	30	16	1,2	15°		•	•	8 480	drevo	B-07939	20,19 €
180	CSMX18024E	2	20	24	1,2	15°		•	•	8 480	drevo	B-08028	20,69 €
180	CSMX18024G	2	30	24	1,2	15°		•	•	8 480	drevo	B-08034	21,39 €
185	CSCX18516G	2	30	16	1,2	15°	15,88/20	•	•	8 250	drevo	B-07945	23,09 €
185	CSMX18524G	2	30	24	1,2	15°	15,88/20	•	•	8 250	drevo	B-32035	28,19 €
190	CSCX19012C	2	15,88	12	1,2	15°		•	•	8 040	drevo	B-07951	18,49 €
190	CSCX19012G	2	30	12	1,2	15°	15,88/20	•	•	8 040	drevo	B-31974	26,69 €
190	CSMX19024G	2	30	24	1,2	15°	15,88/20	•	•	8 040	drevo	B-32041	29,49 €
190	CSMX19024C	2	15,88	24	1,2	15°		•	•	8 040	drevo	B-08062	20,99 €
210	CSCX21016G	2,3	30	16	1,4	15°		•	•	7 300	drevo	B-07973	29,59 €
210	CSMX21024G	2,3	30	24	1,4	15°		•	•	7 300	drevo	B-08078	31,79 €
210	CSFX21040G	2,3	30	40	1,4	15°		•	•	7 300	drevo	B-32079	42,39 €
230	CSCX23018G	2,3	30	18	1,6	15°		•	•	6 640	drevo	B-07989	31,09 €
230	CSMX23024G	2,3	30	24	1,6	15°		•	•	6 640	drevo	B-08084	38,39 €
230	CSFX23040G	2,3	30	40	1,6	15°		•	•	6 640	drevo	B-08115	36,69 €
235	CSCX23520G	2,3	30	20	1,6	15°	15,88/25	•	•	6 500	drevo	B-07995	33,79 €
235	CSMX23524G	2,3	30	24	1,6	15°		•	•	6 500	drevo	B-08090	37,09 €
235	CSFX23540G	2,3	30	40	1,6	15°	15,88/25	•	•	6 500	drevo	B-08121	39,99 €

Pre kotúčové píly

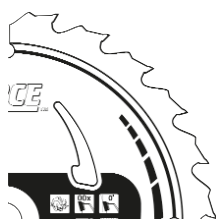

Revolučná zdokonalená konštrukcia zuby, ktorá stanovuje nový medzník v technológii pílových kotúčov. Dvojito zošíkmený bok zuby má ostrejšie rezné hrany a tvar M je rovnocenný dvojnásobnému počtu zubov na kotúči. Väčšia trecia plocha a viac rezných plôch má za následok, že kotúč vydrží až 2x dlhšie ako tradičné kotúče.

Rovnaký výsledok s polovicou zubov
Agresívny rez
Väčšia trecia plocha a dlhšia životnosť

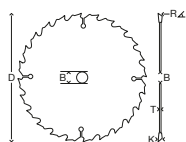

DLHŠIA ŽIVOTNOSŤ

Zošikmená bočná a horná plocha vytvára 6 rezných hrán, čím výrazne predlžuje životnosť v porovnaní s tradičnými kotúčmi.



VÄČŠIA RÝCHLOSŤ REZU

Zošikmený bok zuby má dva uhly 10, ktoré vytvárajú agresívnejší a rýchlejší rez.



ČISTEJŠÍ REZ

Špička tvaru M má viac rezných bodov, čo spôsobuje čistejší rez. Kotúč s 24 zubami má rovnaký výsledok ako 48 zubov u tradičných kotúčoch.



Akumulátory
Odkladacie systémy
Vrtanie
Skrutkovanie
Brúsky
Pílenie
Frézovanie
Brúsenie
Klince / spony
Špeciálne stroje
Vysávanie
Fény/lampy
Záhraďa
Ručné náradie
Ostatné

DELENIE: PÍLOVÉ KOTÚČE

Ø kotúča (mm)	ID kód	hrúbka zubu (mm)	vrtanie (mm)	počet zubov	hrúbka kotúča (mm)	uhol zubu	Ø krúžku (mm)	rez priečny	rez pozdĺžny	max. otáčiky (min ⁻¹)	materiál	Obj. č.	MOC s DPH
Pre kotúčové píly													
140	CSC14018C	1,5	15,88	18	1	20°		• •		10 910	drevo	B-08137	26,29 €
150	CSM15024E	2,4	20	24	1,5	20°		• •		10 180	drevo	B-08280	30,19 €
160	CSC16016E	2,4	20	16	1,5	20°	15,88	• •		9 540	drevo	B-08143	25,49 €
160	CSM16024E	2,4	20	24	1,5	20°	15,88	• •		9 540	drevo	B-32203	38,19 €
160	CSM16040E	2,4	20	40	1,5	20°	15,88	• •		9 540	drevo	B-32297	41,79 €
165	CSC16510E	2	20	10	1,4	20°		• •		9 250	drevo	B-32100	28,99 €
165	CSC16510G	2	30	10	1,4	20°		• •		9 250	drevo	B-08165	23,49 €
165	CSM16524G	2,4	30	24	1,5	20°		• •		9 250	drevo	B-08305	28,59 €
165	CSM16540G	2,4	30	40	1,5	20°		• •		9 250	drevo	B-08436	36,59 €
170	CSC17016G	2,4	30	16	1,5	20°	15,88	• •		8 980	drevo	B-08171	25,69 €
170	CSM17024G	2,4	30	24	1,5	20°	15,88	• •		8 980	drevo	B-08311	28,49 €
170	CSM17040G	2,4	30	40	1,5	20°	15,88	• •		8 980	drevo	B-32312	cena na vyžiadanie
180	CSC18016G	2,4	30	16	1,5	20°		• •		8 480	drevo	B-08193	23,69 €
180	CSM18024E	2,4	20	24	1,5	20°		• •		8 480	drevo	B-08327	29,29 €
180	CSM18024G	2,4	30	24	1,5	20°		• •		8 480	drevo	B-08333	30,59 €
180	CSM18040E	2,4	20	40	1,5	20s		• •		8 480	drevo	B-08458	32,79 €
180	CSM18040G	2,4	30	40	1,5	20°		• •		8 480	drevo	B-08464	32,79 €
185	CSC18516C	1,8	15,88	16	1,2	20°		• •		8 250	drevo	B-08202	24,89 €
185	CSM18524C	1,8	15,88	24	1,2	20°		• •		8 250	drevo	B-08349	29,79 €
185	CSM18540C	1,8	15,88	40	1,2	20°		• •		8 250	drevo	B-08470	36,69 €
190	CSC19012G	2	30	12	1,4	20°	15,88/20	• •		8 040	drevo	B-08224	26,89 €
190	CSM19024G	2,2	30	24	1,4	20°	15,88/20	• •		8 040	drevo	B-32247	cena na vyžiadanie
190	CSM19024C	2,2	15,88	24	1,4	20°		• •		8 040	drevo	B-08361	30,19 €
190	CSM19040G	2,2	30	40	1,4	20°	15,88/20	• •		8 040	drevo	B-32340	45,09 €
190	CSM19040C	2,2	15,88	40	1,4	20°		• •		8 040	drevo	B-08492	33,49 €
190	CSXF19060G	2,2	30	60	1,4	15°	15,88/20	• •		8 040	drevo	B-32390	45,39 €
210	CSC21016G	2,4	30	16	1,6	20°		• •		7 300	drevo	B-32150	cena na vyžiadanie
210	CSM21024G	2,4	30	24	1,6	20°		• •		7 300	drevo	B-08377	37,89 €
210	CSM21040G	2,4	30	40	1,6	20°		• •		7 300	drevo	B-32356	44,89 €
230	CSM23024G	2,3	30	24	1,6	20°		• •		6 640	drevo	B-08383	40,09 €
230	CSM23040G	2,6	30	40	1,6	20°		• •		6 640	drevo	B-08517	53,59 €
230	CSXF23060G	2,8	30	60	1,8	15°		• •		6 640	drevo	B-08567	43,99 €
235	CSC23518G	2,6	30	18	1,6	20°		• •		6 500	drevo	B-08252	41,99 €
235	CSM23520G	2,3	30	20	1,6	20°		• •		6 500	drevo	B-08399	32,79 €
235	CSM23524G	2,3	30	24	1,6	20°		• •		6 500	drevo	B-08408	41,19 €
235	CSM23540G	2,6	30	40	1,6	20°		• •		6 500	drevo	B-08523	43,59 €
235	CSXF23560G	2,8	30	60	1,8	15°		• •		6 500	drevo	B-32415	48,29 €
270	CSC27024G	2,6	30	24	1,8	20°		• •		5 650	drevo	B-32172	51,49 €
270	CSM27040G	2,6	30	40	1,6	20°		• •		5 650	drevo	B-08539	60,09 €
270	CSXF27060G	2,8	30	60	1,8	15°	20	• •		5 650	drevo	B-08573	69,59 €
355	CSC35524G	3	30	24	2,2	20°		• •		4 300	drevo	B-32188	79,39 €
355	CSM35540G	3	30	40	2,2	20°		• •		4 300	drevo	B-32281	97,59 €
355	CSM35560G	3	30	60	2,2	20°		• •		4 300	drevo	B-08545	88,19 €
355	CSXF35560G	2,8	30	60	1,8	15°		• •		4 300	drevo	B-32421	cena na vyžiadanie



Komplexná rada pilových kotúčov pre všetky značky a modely ručných kotúčových pí. Bohatý výber veľkostí od 140 mm – 355 mm a počtu zubov od 10 – 60 pokrýva možnosti použitia pre hrubé pozdĺžne a priečne rezy až po extra jemné priečne rezy.

Tvrdené a vystužené kotúče absorbujú rázy a zostávajú ploché a rovné.

Výrazné predĺženie životnosti kotúčov vďaka použitiu prvotriedneho karbidu wolframu s pomalým opotrebením.

Úzka rezná špára s menším množstvom odpadu a menším vodiacim tlakom.

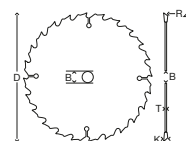

DELENIE: PÍLOVÉ KOTUČE

Ø kotúča (mm)	ID kód	hrúbka zubu (mm)	vrtanie (mm)	počet zubov	hrúbka kotúča (mm)	uhol zubu	Ø krúžku (mm)	rez priechy	rez pozdĺžny	max. otáčiky (min ⁻¹)	materiál	Obj. č.	MOC s DPH

190	MSC19024EL	2,2	20	24	1,6	5°		•		8 040	drevo	B-08604	48,39 €
190	MSF19060EL	2	20	60	1,4	5°		•		8 040	drevo	B-08757	63,09 €
200	TSM20036GL	2,6	30	36	1,6	20°		•	•	7 630	drevo	B-33473	cena na vyžiadanie
216	MSM21648GL	2,4	30	48	1,6	5°		•		7 070	drevo	B-08632	81,19 €
216	MSM21660GL	2,1	30	60	1,6	5°		•		7 070	drevo	B-08676	85,99 €
216	MSXF21680GL	2,8	30	80	1,8	5°		•		7 070	drevo	B-08791	97,29 €
250	TSM25040GL	2,8	30	40	1,8	20°		•	•	6 110	drevo	B-09818	106,99 €
250	TSF25080GL	2,8	30	80	1,8	15°		•	•	6 110	drevo	B-08838	157,49 €
255	MSC25532GL	2,3	30	32	1,8	5°		•		5 990	drevo	B-08626	72,49 €
255	MSM25540GL	2,4	30	40	1,8	5°		•		5 990	drevo	B-08648	89,19 €
255	MSM25560GL	2,3	30	60	1,8	5°		•		5 990	drevo	B-08682	103,99 €
255	MSF25572GL	2,4	30	72	1,8	5°		•		5 990	drevo	B-08763	103,19 €
260	MSM26040GL	2,3	30	40	1,8	5°		•		5 870	drevo	B-08654	87,19 €
260	TSM26040GL	2,8	30	48	1,8	20°		•	•	5 870	drevo	B-09824	131,59 €
260	MSM26060GL	2,3	30	60	1,8	5°		•		5 870	drevo	B-08698	102,59 €
260	MSM26070GL	2,3	30	70	1,8	5°		•		5 870	drevo	B-08707	84,69 €
260	MSF26080GL	2,3	30	80	1,8	5°		•		5 870	drevo	B-08779	112,29 €
260	TSF26080GL	2,8	30	80	1,8	15°		•	•	5 870	drevo	B-08844	133,29 €
260	MSXF260100GL	2,3	30	100	1,8	5°		•		5 870	drevo	B-08800	113,99 €
300	TSM30048GL	2,8	30	48	1,8	20°		•	•	5 090	drevo	B-09830	112,79 €
300	TSF300100GL	2,8	30	100	1,8	15°		•	•	5 090	drevo	B-32661	cena na vyžiadanie
305	MSM30540GL	2,3	30	40	1,8	5°		•		5 000	drevo	B-08660	106,79 €
305	MSM30560GLA	2,6	30	60	2	5°		•		5 000	drevo	B-08729	131,09 €
305	MSM30570GL	2,5	30	70	1,9	0°		•		5 000	drevo	B-08735	109,09 €
305	MSF30580GL	2,3	30	80	1,8	5°		•		5 000	drevo	B-08785	128,09 €
305	MSXF305100GL	2,3	30	100	1,8	5°		•		5 000	drevo	B-08816	145,59 €
350	TSM35056GL	3,5	30	56	2,5	20°		•	•	4 360	drevo	B-09846	124,19 €
355	MSM35580GL	3	30	80	2,2	5°		•		4 300	drevo	B-08741	180,69 €

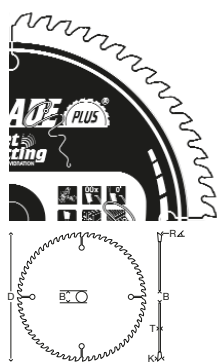

Pílové kotúče MakBlade Plus pre pokosové a stolné píly majú jedinečnú patentovanú technológiu. Tieto kotúče sú vyvinuté k pohlietniu vibrácií a veľmi tichému chodu. Majú vlastnosti zlepšovať pracovné prostredie, životnosť kotúča a spoľahlivosť celého zariadenia. Kotúč s menšími vibráciami zaisťujú presnejšie vedenie rezu a tiež znižujú hádzavosť. Výsledným efektom je ideálna rezná plocha. Taktiež má za dôsledok významne dlhšiu životnosť zubov z karbidu wolframu prekračujúcu životnosť konvenčných pílových kotúčov s karbidovými hrotmi.

Presne vystužené kotúče s plochejším ostrím a rovnejším rezom

Povrchová vrstva s veľmi malým trením znamená rezanie bez námahy a ochranu pred koróziou.



NÍZKE VIBRÁCIE

Vďaka antivibračnej laserom rezanej drážke.



TICHÉ REZANIE

Povrchová vrstva s veľmi malým trením. Hlučnosť pílového kotúča je jednou z hlavných nepríjemností na pracovisku. MakBlade plus zaisťujú menej hlučné pracovné prostredie.



Akumulátory
Odkladacie systémy
Vrtanie
Skrutkovanie
Brúsky
Pílenie
Frézovanie
Brúsenie
Klince / spony
Špeciálne stroje
Vysávanie
Fény/lampy
Záhrada
Ručné náradie
Ostatné

DELENIE: PÍLOVÉ KOTUČE

Ø kotúča (mm)	ID kód	hrúbka zubu (mm)	vrtanie (mm)	počet zubov	hrúbka kotúča (mm)	uhol zubu	Ø krúžku (mm)	rez priechy	rez pozdĺžny	max. otáčiky (min ⁻¹)	materiál	Obj. č.	MOC s DPH

190	MSC19024E	2,2	20	24	1,6	5°		•	8 040		Drevo	B-08894	30,19 €
190	MSM19048E	2,2	20	48	1,6	5°		•	8 040		Drevo	B-08953	52,59 €
190	MSF19060E	2	20	60	1,4	5°		•	8 040		Drevo	B-09042	48,99 €
216	MSC21624G	2,4	30	24	1,6	5°		•	7 070		Drevo	B-08903	42,29 €
216	CMSM21640G	2,1	30	40	1,6	10°		•	7 070		Drevo	B-08872	60,69 €
216	MSM21648G	2,4	30	48	1,6	5°		•	7 070		Drevo	B-32764	61,79 €
216	MSF21660G	2	30	60	1,4	5°		•	7 070		Drevo	B-09058	53,19 €
216	MSXF21680G	2,8	30	100	1,8	5°		•	7 070		Drevo	B-32867	62,59 €
250	MSC25032G	2,4	30	32	1,6	5°		•	6 110		Drevo	B-08919	49,49 €
250	MSM25048G	2,4	30	48	1,8	5°		•	6 110		Drevo	B-08975	57,59 €
250	MSM25060G	2,3	30	60	1,8	5°		•	6 110		Drevo	B-09008	62,79 €
250	MSF25072G	2,4	30	72	1,8	5°		•	6 110		Drevo	B-09064	57,39 €
250	MSXF250100G	2,3	30	100	1,8	5°		•	6 110		Drevo	B-09101	67,79 €
255	MSC25532G	2,3	30	32	1,8	5°		•	5 990		Drevo	B-08925	76,89 €
255	CMSM25548G	2,1	30	48	1,6	10°		•	5 990		Drevo	B-32699	70,59 €
255	MSM25560G	2,3	30	60	1,8	5°		•	5 990		Drevo	B-32729	cena na vyžiadanie
260	MSC26032G	2,3	30	32	1,8	5°		•	5 870		Drevo	B-08931	53,09 €
260	MSM26040G	2,3	30	40	1,8	5°		•	5 870		Drevo	B-32770	46,49 €
260	MSM26060G	2,3	30	60	1,8	5°		•	5 870		Drevo	B-32801	59,89 €
260	MSF26080G	2,3	30	80	1,8	5°		•	5 870		Drevo	B-09070	63,49 €
260	MSXF260100G	2,3	30	100	1,8	5°		•	5 870		Drevo	B-09117	73,89 €
305	MSC30532G	2,3	30	32	1,8	5°		•	5 000		Drevo	B-08947	59,09 €
305	MSM30540G	2,3	30	40	1,8	5°		•	5 000		Drevo	B-08997	58,79 €
305	MSM30560G	2,3	30	60	1,8	5°		•	5 000		Drevo	B-09036	70,09 €
305	MSF30580G	2,3	30	80	1,8	5°		•	5 000		Drevo	B-09086	79,99 €
305	MSXF305100G	2,3	30	100	1,8	5°		•	5 000		Drevo	B-09123	86,59 €
315	TSC31528G	2,8	30	28	2,0	20°		•	4850		Drevo	B-46171	73,09 €
315	TSC31560G	2,8	30	60	2,0	10°		•	4850		Drevo	B-46193	92,09 €
315	TCS31540G	2,8	30	40	2,0	9°		•	4 850		Drevo	JM27170001	33,99 €

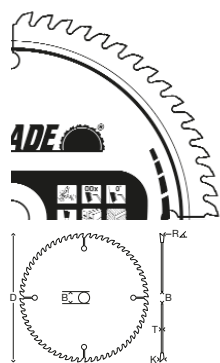

Komplexný výber pílových kotúčov pre všetky značky a modely pokosových píl a ponorných píl vrátane aku píl. Bohatý výber veľkostí od 190 mm–305 mm a počtu zubov od 24 do 100 pokrýva možnosti použitia od hrubých rezov až po prácu so zvlášť jemnou povrchovou úpravou. Tvrdené a vystužené kotúče absorbujú rázy a zostávajú ploché a rovné. Úzka rezná špára s menším množstvom odpadu.



MENŠIA NÁMAHA

Úzka rezná špára znižuje namáhanie počas práce a predlžuje predpokladanú životnosť ako stroja, tak kotúča.



DLHÁ ŽIVOTNOSŤ

Prvotriedne zuby TCT, pomalé opotrebenie.

DELENIE: PÍLOVÉ KOTUČE

Ø kotúča (mm)	ID kód	hrúbka zubu (mm)	vítanie (mm)	počet zubov	hrúbka kotúča (mm)	uhol zubu	Ø krúžku (mm)	rez priechy	rez pozdĺžny	max. otáčiky (min ⁻¹)	materiál	Obj. č.	MOC s DPH
Špeciálne kotúče pre akku píly *****													
85	CCF8520B	1	15	20	0,7	10°		• •	2 240		drevo	B-33576	12,39 €
136	CCM13624A	1,5	10	24	1	20°		• •	4 500		drevo	B-09139	26,09 €
136	CCF13636A	1,5	10	36	1	18°		• •	4 500		drevo	B-09210	25,79 €
136	CCC13616E	1,5	20	16	1	20°		• •			drevo	B-10643	28,19 €
136	MCCS13630E	1,5	20	30	1,2	0°		• •			kov	B-10615	58,89 €
150	CCM15024A	1,5	10	24	1	20°		• •	2 500		drevo	B-09145	17,89 €
150	CCF15040A	1,5	10	40	1	18°		• •	2 500		drevo	B-09226	29,99 €
160	CCC16024E	1,5	20	24	1	20°		• •	4 770		drevo	B-09151	30,89 €
165	CCC16524E	1,5	20	16	1	20°		• •	4 770		drevo	D-51079	9,69 €
165	BBS16524E	1,5	20	24	1	20°		• •	4 770		drevo	B-09173	26,79 €
165	CCC16524E	1,5	10	24	1	20°		• •	4 770		drevo	B-09189	28,09 €
165	CCF16540E	1,6	20	40	1	18°		• •	4 770		drevo	B-32954	35,29 €
165	BBS16540E	1,6	20	40	1	18°		• •	4 770		drevo	B-09248	29,29 €
165		1,6	20	24	1	18°		• •	9.250		drevo	E-15643	cena na vyžiadanie
190		1,6	30	24	1	18°		• •	8,04		drevo	E-15659	cena na vyžiadanie
190	CCC19024G	2	30	24	1,4	20°		• •	3 000		drevo	B-32926	28,29 €
190	CCM19040G	2	30	40	1,4	10°		• •	3 000		drevo	B-09254	33,89 €

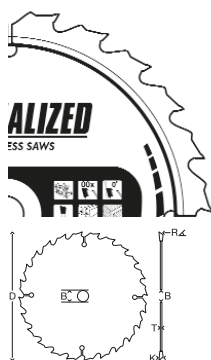

Ušľachtilé pílové kotúče vyrobené špeciálne pre AKKU píly. Ponúkame kotúče na rezanie dreva pomocou všetkých modelov AKKU kotúčových píly v kvalite firmy Makita. Ultratenké, perfektne vystužené oceľové kotúče pre rovné vedenie. Predlžuje výdrž batérií. Presne brúsené z prvotriedneho karbidu pre ľahšie, hladšie rezy a dlhú životnosť. Usporiadanie zubov odpovedá zvláštnym požiadavkám na rezanie.

Pílové kotúče na laminátové dosky

Špeciálne kotúče pre akku píly *****													
85 mm	CCXF8524B	1	15	24	0,7	7°			2240		laminát	B-29430	18,79 €
136 mm	CCXF13648E	1.4	20	48	1	10°			4500		laminát	B-33825	38,29 €
165 mm	CCXF16552EL	1.45	20	52	1	5°			4770		laminát	B-29452	57,09 €
190 mm	MSXF19060GL	2	20	60	1,4	5°			8040		laminát	B-29468	73,19 €
216 mm	MSXF21672GL	2.5	30	72	1,8	5°			7070		laminát	B-29474	95,49 €
250 mm	MSXF25084GL	2.5	30	84	1,8	5°			6110		laminát	B-29480	134,99 €
260 mm	MSXF26084GL	2.5	30	84	1,8	5°			5870		laminát	B-33875	cena na vyžiadanie
305 mm	MSXF30596GL	2.5	30	96	1,8	5°			5000		laminát	B-33881	cena na vyžiadanie



ŠPECIÁLNA KONŠTRUKCIA
Vynikajúce pre Akku píly – predlžuje výdrž batérie a chráni motor.



NAJLEPŠÍ POVRCH
Presne brúsené zuby s povrchom ako zrkadlo a ostrejším britom.



ŠIROKÁ MOŽNOSŤ POUŽITIA
Kotúče vhodné pre širokú škálu možného použitia.

DELENIE: PÍLOVÉ KOTUČE

Ø kotúča (mm)	ID kód	hrúbka zuby (mm)	vrtanie (mm)	počet zubov	hrúbka kotúča (mm)	uhol zuby	Ø krúžku (mm)	rez priechy rez pozdĺžny	max. otáčky (min ⁻¹)	materiál	Obj. č.	MOC s DPH
Špeciálne kotúče pre akku píly – špeciálne zapustené hrot												
165	CSCE16516E	2	20	16	1,25	23°		• •	9 250	drevo	B-33037	40,99 €
165	CSME16524E	2	20	24	1,25	23°		• •	9 250	drevo	B-09391	46,89 €
165	CSME16540E	2	20	40	1,25	18°		• •	9 250	drevo	B-09472	54,59 €
185	CSCE18516G	2	30	16	1,25	25°		• •	8 250	drevo	B-09341	27,49 €
185	CSME18524C	2	15,88	24	1,25	23°		• •	8 250	drevo	B-09400	29,99 €
185	CSME18520G	2	30	20	1,25	25°		• •	8 250	drevo	B-09416	32,69 €
185	CSME18540G	2	30	40	1,25	25°		• •	8 250	drevo	B-09494	46,89 €
190	CSCE19016G	2	30	16	1,25	23°		• •	8 040	drevo	B-09357	30,19 €
190	CSME19024G	2	30	24	1,25	23°		• •	8 040	drevo	B-09422	33,09 €
190	CSME19040G	2	30	40	1,25	23°		• •	8 040	drevo	B-09503	44,79 €
210	CSCE21018G	1,9	30	18	1,4	23°		• •	7 300	drevo	B-33065	cena na vyžiadanie
210	CSME21024G	1,9	30	24	1,4	23°		• •	7 300	drevo	B-33124	cena na vyžiadanie
235	CSCE23520G	2,3	30	20	1,6	25°		• •	6 500	drevo	B-09379	43,19 €
235	CSME23524G	2,3	30	24	1,6	23°		• •	6 500	drevo	B-09444	44,39 €
235	CSME23548G	2,3	30	48	1,6	18°		• •	6 500	drevo	B-09519	62,39 €
270	CSME27024G	2,6	30	24	1,8	23°		• •	5 650	drevo	B-33146	103,39 €
355	CSCE35524G	3	30	24	2,2	23°		• •	4 300	drevo	B-33087	cena na vyžiadanie
355	CSME35540G	3	30	40	2,2	23°		• •	4 300	drevo	B-33152	cena na vyžiadanie

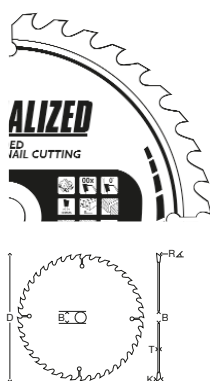

Kotúče so zapustenými hrotmi, alebo „hlbokými zubmi“ sú navrhnuté tak, aby vyhovovali pílam Makita i iných výrobcov. Sú to veľmi pevné kotúče odolné proti opotrebovaniu.

Ľahko si poradí s „hrčovitým“ drevom a ani rezanie dreva s klineciami alebo skrutkami jeho zuby nepoškodí. Sú obzvlášť vhodné pre použitie na stavebné drevo a demolačné práce. Rezanie klineciv a „hrč“.

Extrémne pevný a odolný proti opotrebovaniu. Dlhšia životnosť a zvýšená produktivita.



CHRÁNENÉ ZUBY

Kotúče so zapustenými hrotmi alebo hlbokými zubmi majú veľmi silnú väzbu medzi telom listu a hrotom TCT.



VYSOKÉ NÁROKY

Zvlášť vhodné na bednenie a iné náročné práce. Vynikajúce na rezanie dreva s „hrčami“ a klineciami.

DELENIE: PÍLOVÉ KOTUČE

Ø kotúča (mm)	ID kód	hrúbka zubu (mm)	vítanie (mm)	počet zubov	hrúbka kotúča (mm)	uhol zubu	Ø krúžku (mm)	rez priechy	rez pozdĺžny	max. otáčky (min ⁻¹)	materiál	Obj. č.	MOC s DPH
Špeciálne kotúče na rezanie hliníka pre kotúčové, pokosové a stolné píly *****													
160	CSA16060E	2,4	20	58	1,8	0°				9 540	hliník	B-33233	48,99 €
160	CSA16060G	2,4	30	60	1,8	0°	20			9 540	hliník	B-09569	43,69 €
180	CSA18060G	2,4	30	60	1,8	0°	15,88/20			8 480	hliník	B-09575	52,49 €
190	CSA19060G	2,4	30	60	1,8	0°	15,88/20			8 040	hliník	B-09597	67,89 €
190	MSA19060E	2	20	60	1,4	-5°				8 040	hliník	B-09612	60,29 €
200	TSA20064G	2,8	30	64	2,2	0°				7 630	hliník	B-09690	82,79 €
216	MSA21664G	2,2	30	64	1,6	-5°				7 070	hliník	B-09628	68,79 €
235	CSA23580G	2,4	30	80	1,8	0°				6 500	hliník	B-09606	77,19 €
250	MSA25080G	2,4	30	80	1,8	-5°				6 110	hliník	B-33308	75,39 €
250	TSA25080G	2,8	30	80	2,2	0°				6 110	hliník	B-09709	92,49 €
250	MSA250100G	2,4	30	100	1,8	-5°				6 110	hliník	B-09640	75,69 €
260	MSA26080G	2,3	30	80	1,8	-5°				5 870	hliník	B-33320	80,69 €
260	TSA26080G	2,8	30	80	2,2	0°				5 870	hliník	B-09715	108,49 €
260	MSA260100G	2,3	30	100	1,8	-5°				5 870	hliník	B-33336	91,79 €
300	TSA30080G	2,8	30	80	2,2	0°				5 090	hliník	B-09721	115,09 €
305	MSA30580G	2,3	30	80	1,8	-5°				5 000	hliník	B-33342	114,19 €
305	MSA305100G	2,3	30	100	1,8	-5°				5 000	hliník	B-33358	125,49 €
350	TSA350100G	3,2	30	100	2,6	0°				4 360	hliník	B-33401	cena na vyžiadanie
355	TSA355120G	3	30	120	2,4	-5°				4 360	hliník	B-12522	185,09 €

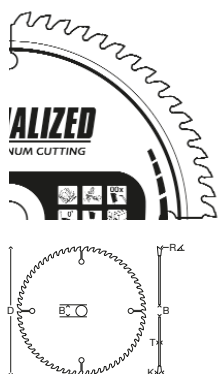

Rada kotúčov pre ručné, pokosové a stolné píly s vynikajúcim rezným výkonom pre hliník, meď, mosadz, bronz a iné farebné kovy. Kotúče sú vhodné aj k práci s plastmi a laminovaným drevom.

Pri rezaní farebných kovov je treba na hroty používať mazivo, aby sa v drážkach kotúča nehromadili triesky.

Presne vystužené kotúče pre plochšie brity a rovnejšie rezy.

Vynikajúca kvalita rezu farebných kovových materiálov.

Špičkový výkon pri laminátových podlahových materiáloch.

Ø kotúča (mm)	ID kód	hrúbka zubu (mm)	vítanie (mm)	počet zubov	hrúbka kotúča (mm)	uhol zubu	tvár zubu	max. otáčky (min ⁻¹)	materiál	Obj. č.	MOC s DPH
Pílové kotúče na hliník ***											
185		2,2	30	40	1,4	5°	TCG	8300	hliník	D-62103	10,69 €
190		2,2	30	60	1,4	5°	TCG	8040	hliník	D-72970	21,09 €
235		2,4	30	80	1,6	5°	TCG	6550	hliník	D-72992	29,59 €
260		2,8	30	70	1,8	5°	TCG	5870	hliník	D-73003	32,79 €
260		2,6	30	100	1,8	5°	TCG	5870	hliník	D-61874	36,19 €
260		2,6	30	120	1,8	5°	TCG	5870	hliník	D-61880	32,79 €



PERFEKTNÝ PROFIL

Zuby so špeciálnym profilom pre farebné kovy.



MÁLO TRIESOK

Pri použití na laminátové podlahové materiály vytvára málo triesok a odštiepkov.

DELENIE: PÍLOVÉ KOTUČE

Ø kotúča (mm)	ID kód	hrúbka zubu (mm)	vrtanie (mm)	počet zubov	hrúbka kotúča (mm)	uhol zubu	Ø krúžku (mm)	rez priechy	rez pozdĺžny	max. otáčiky (min ⁻¹)	materiál	Obj. č.	MOC s DPH
špeciálne kotúče na rezanie kovov pre kotúčové a skracovacie píly *****													
185	MCS18536G	1,9	30	36	1,5	0°				5 800	mäkká oceľ	B-33417	96,19 €
185	MCS18538G	2	30	38	1,6	0°				5 800	mäkká oceľ	B-09759	73,29 €
185	MCS18548G	2	30	48	1,6	0°				5 800	mäkká oceľ	B-33451	81,49 €
185	MCS18570G	1,7	30	70	1,3	-10°				5 800	plech	B-09771	77,29 €
305	MCS30560F	2,1	25,4	60	1,7	0°				2 000	mäkká oceľ	B-33439	cena na vyžiadanie
305	MCS30578F	2,3	25,4	78	2	-5°				2 000	tenká mäkká oceľ	B-09793	217,59 €

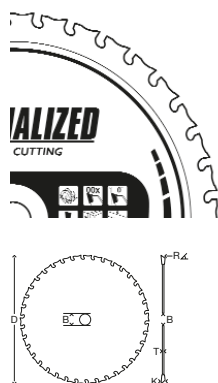

Rada pílových kotúčov Makita na rezanie ocele konštruovaných tak, aby bol rez čistejší a rýchlejší. Predovšetkým vďaka zloženiu karbidu a špeciálnej konštrukcii hrotov sú tieto kotúče odolné proti nárazom a majú dlhú životnosť pri rezaní mäkkej oceli, plechu, potrubia, profilov alebo závitových tyčí.

Kotúče Makita zaisťujú rýchlejší a čistejší rez, pričom vydržia až 30 krát dlhšie ako klasické rezné kotúče. Presne nabrúsené hroty so špeciálnym zložením karbidu pre rýchle a čisté rezy. Malá iskrivosť a minimálna tvorba prachu. Menšie náklady na rez.

Špeciálne kotúče pre ponorné píly

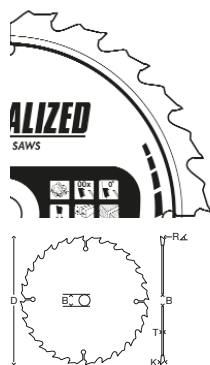

Kotúče konštruované špeciálne pre ponorné píly sú určené na rezanie dreva a hliníku. Majú zvláštnu konštrukciu zaisťujúcu hladký a čistý rez. Kotúče pre ponorné píly majú podobnú špecifikáciu ako Premium MakBlade Plus s patentovanou technológiou eliminujúcou vibrácie. Práca s kotúčmi s nízkymi vibráciami je presnejšia pri menšom hádzaní a ľahko sa ponorí do materiálu pri vynaložení malého úsilia. Špeciálna antivibračná konštrukcia. Presne vystužené kotúče s plochejšími britmi pre perfektne rovné rezy. K dispozícii kotúče na rezanie dreva a hliníku.



Pílové kotúče pre ponorné píly

Pílové kotúče pre ponorné píly *****													
160	CSP16028E	2,2	20	28	1,6	23°		• •		9 540	drevo	B-09260	41,69 €
160	CSP16048E	2,2	20	48	1,6	8°		• •		9 540	drevo	B-09276	51,49 €
165	CSP16528E	2,2	20	28	1,6	23°		• •		9 250	drevo	B-33009	56,89 €
165	CSP16548E	2,2	20	48	1,6	8°		• •		9 250	drevo	B-33015	70,29 €
165	CSPX16556E	2,4	20	56	1,7	-3°		• •		9 250	hliník	B-33021	87,49 €
165	CSPX16548E	2,4	20	48	1,7					9 250	corrian	B-56742	75,99 €

DELENIE: PÍLOVÉ KOTUČE

Ø kotúča (mm)	ID kód	hrúbka rezu (mm)	vŕtanie (mm)	počet zubov	hrúbka kotúča (mm)	uhol zubu	tvar zubu	max. otáčky (min ⁻¹)	materiál	Obj. č.	MOC s DPH
Špeciálne pílové kotúče na vlákno cementové a cementové dosky *****											
165	CSC1654EPCD	2,1	20	4	1,4	10°			cementové dosky	B-33685	71,19 €
190	CSC1904GPCD	2,1	30	4	1,4	10°			cementové dosky	B-23008	62,79 €

Ako jeden z rastúcich ekologických materiálov v stavebníctve si vyžaduje vlákno-cementová doska dokonalý pílový kotúč a práve ten vytvorila spoločnosť Makita.

Sortiment pílových kotúčov PCD od spoločnosti Makita bol navrhnutý tak, aby poskytoval vynikajúci výkon pri rezaní vlákno-cementových dosiek vrátane dosiek „Hardy Board“, „Marley Weatherboard“ a lisovaného betónu.

Kotúč pílový na cementové dosky ***											
190		1,8	30	4	1,4	12°	PCD	8040	cementové dosky	D-72073	36,39 €

Špeciálne kotúče na rezanie sendvičových panelov pre kotúčové píly *****											
165	CSF16542EL	1,75	20	45	1,4	0°		9250	sendvič. panel	B-63149	78,29 €
235	CSF23550GL	2,4	30	50	1,8	0°		6 500	sendvič. panel	B-33582	98,29 €
235	CSF23550GL	2,4	30	50	1,8	0°	SMTCG	6500	sendvič. panel	B-33582	98,29 €
270	CSF27060GL	2,6	30	60	2,0	0°		5 650	sendvič. panel	B-33598	171,19 €
355	CSF35580GL	3,2	30	80	2,6	0°		4 300	sendvič. panel	B-33607	198,09 €

Pílové kotúče vyrobené špeciálne pre rezanie sendvičových panelov. Extrémne pevné a odolné proti opotrebeniu, dlhá životnosť a produktivita.

Špeciálne pílové kotúče konštrukt pre kotúčové píly *****											
190	CSCE19012G	2,6	30	12	1,6	20°			drevo	B-13683	30,09 €
235	CSCE23516G	3,0	30	16	2,6	20°			drevo	B-13699	37,39 €

Špeciálna konštrukcia zubov týchto pílových kotúčov umožňuje rezať stavebné drevo s klinkami. Extrémne pevné a odolné proti opotrebeniu, dlhá životnosť a produktivita.





Pílové kotúče pre pokosové a kotúčové píly ***											
190		2,2	30	24	1,4	15°		8040	drevo	D-64951	11,79 €
190		2	30	40	1,3	18°		8040	drevo	D-64973	14,29 €
260		2,6	30	40	1,8	15°		5870	drevo	D-65377	20,69 €
260		2,6	30	60	1,8	15°		5870	drevo	D-65383	25,99 €
260		2,6	30	80	1,8	12°		5870	drevo	D-65399	29,09 €
260		2,6	30	100	1,8	12°		5870	drevo	D-65408	30,79 €

Redukčné krúžky pre pílové kotúče *****										
---	--	--	--	--	--	--	--	--	--	--

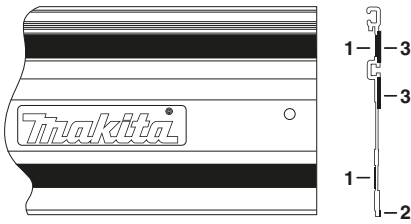

parametre	obj. č.	MOC s DPH
20 mm × 15,88 mm × 1,2 mm	B-20987	2,69 €
20 mm × 15,88 mm × 1,8 mm	B-20993	2,79 €
30 mm × 15,88 mm × 1,2 mm	B-21004	2,79 €
30 mm × 15,88 mm × 1,8 mm	B-21010	2,69 €
30 mm × 20 mm × 1,2 mm	B-21026	2,99 €
30 mm × 20 mm × 1,4 mm	B-21032	2,79 €
30 mm × 20 mm × 1,8 mm	B-21048	3,09 €
30 mm × 25 mm × 1,6 mm	B-21054	2,69 €
30 mm × 25,4 mm × 1,4 mm	B-21060	2,79 €
30 mm × 25,4 mm × 2,2 mm	B-21076	2,69 €

DELENIE: PRÍSLUŠENSTVO PRE KOTÚČOVÉ PONORNÉ A POKOSOVÉ PÍLY

	model	Obj. č.	MOC s DPH
Paralelný doraz *****			
	DCS550, DCS551, DCS553, DHS630, DHS660, DHS661, DHS680, DHS710, DHS711, DHS782, DHS783, DSS500, DSS501, DSS610, DSS611, 4191D, 5093D, 5094D, HS300D, 5005BA, 5007F, 5007FA, 5007MG, 5007MGA, 5007N, 5007NB, 5007NF, 5008MG, 5008MGA, 5606B, 5704R, 5740NB, 5800NB, 5806B, HS6100, HS6101, HS6600, HS6601, HS7000, HS7010, HS7010, HS7100, HS7101, HS7600, HS7601, HS7610, HS7611, HS004G	164095-8	1,99 €
	DSP600, DSP601, SP6000	165447-6	9,99 €
	5017RKB, 5705R	165108-8	7,49 €
	HS0600, N5900B, 5902B,	164367-1	2,79 €
	5103R, 5104, 5104S, 5903R	165084-6	5,39 €
	5143R	152498-8	cena na vyžiadanie
Adaptér odsávací			
	5603R, 5704R, 5705R/RK	192420-3	2,99 €
	DHS660, DHS661	199230-9	cena na vyžiadanie
	DHS680	196961-1	1,29 €
	DHS710, DHS780, DHS781, DHS782, DHS783, HS003G, HS004G HS6600, HS6601, HS7000, HS7010, HS7601, HS7610, HS7611	196520-1	2,79 €
	DHS711, HS6600	196843-7	2,99 €
	5103R	415426-7	2,09 €
Vak na prach			
	SP6000	122562-9	16,49 €
	DSP600, DSP601	126599-8	13,39 €
Vodiace lišty *****			
	1000 mm	199140-0	57,49 €
	1500 mm	199141-8	75,89 €
	3000 mm	194367-7	182,59 €
	spojka vodiacej lišty (sada 2 ks)	198885-7	26,99 €
Náhradné gumeny pre vodiace lišty			
	gumenný samolepiaci pás (1) na lištu 1400 mm	413101-9	1,99 €
	gumenný samolepiaci pás (2) na lištu 1400 mm	423359-2	4,39 €
	penový samolepiaci pás (3) na lištu 1400 mm	423361-5	5,98 €
	gumenný samolepiaci pás (1) na lištu 1900 mm	451330-6	18,68 €
	gumenný samolepiaci pás (2) na lištu 1900 mm	423386-9	5,34 €
	penový samolepiaci pás (3) na lištu 1900 mm	423390-8	5,53 €
	gumenný samolepiaci pás (1) na lištu 3000 mm	413102-7	4,25 €
	gumenný samolepiaci pás (2) na lištu 3000 mm	423360-7	8,71 €
penový samolepiaci pás (3) na lištu 3000 mm	423362-3	7,62 €	
Upínacie svorky			
	skrutková svorka (sada 2 ks)	194385-5	36,09 €
	quick systém svorka (sada 2 ks)	199826-6	101,79 €
Uhlový adaptér k vodiacej lište			
		196664-7	39,39 €
Hák na zavesenie			
	DHS660, DHS661	199231-7	9,34 €
	DHS782, DHS783, HS003G, HS004G	199386-8	17,09 €

DELENIE: PÍLOVÉ KOTUČE

Adaptéry pre vodiace lišty Makita

Adapér	A	B	C	D	E	F (N)	G	H	I	J	K	L	M	N (F)	O	P	Q	R
	Kotúčové píly													Primočiarié píly		Frézy	Píly	
Model	HS7100 HS7101	DHS630 HS6100 HS6101	HS7601 HS7610 HS7611	DHS680 HS012G	HS6600 HS6601	DHS630 DHS710 DHS711 HS6100 HS6101 HS7100 HS7101	HS0600	5603 5703 5705R	DHS660 DHS661	HS002G	HS006G	5903R	5103R	DJV141, DJV142, DJV180, DJV181, DJV182	DJV141 DJV142 DJV180 DJV181 DJV182	JV102D JV103D	*DRT50 3612BR RP0900 RP0910 RP1110C RP1800 RP1800F RP1801 RP1801F RP2300FC RP2301F *RT001G *RT0702C RP1803F RP2303FC	DCC500 DCC501 4100KB, 4100NH2
Obj. č.	195837-9	195838-7	197005-0	196953-0	197462-2	197252-3	198570-2	192505-5	199232-5	199401-8	1911L92-3	192506-3	192507-1	197252-3	193517-1	198704-7	194579-2	198673-2
MOC s DPH	cena na vyžiadanie	cena na vyžiadanie	19,09 €	51,19 €	36,59 €	82,89 €	229,49 €	34,89 €	53,79 €	cena na vyžiadanie	cena na vyžiadanie	162,59 €	110,69 €	82,89 €	25,39 €	cena na vyžiadanie	40,59 €	25,59 €

* s použitím základne 195563-0

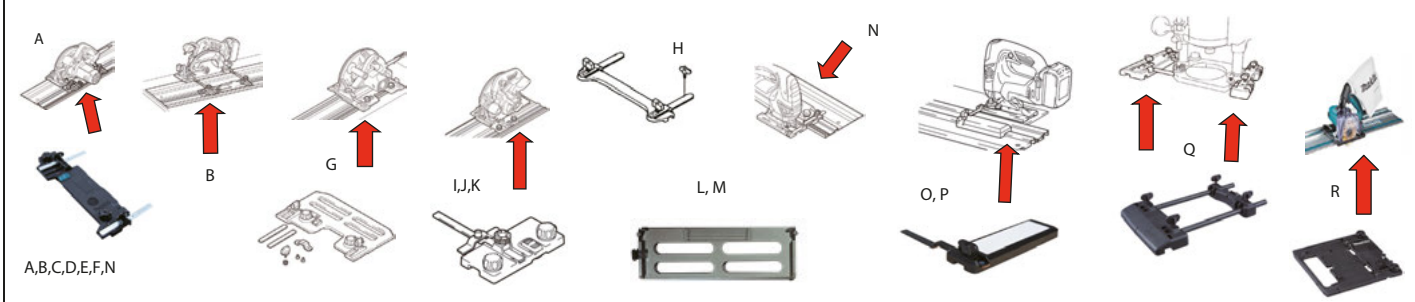

Modely píľ priame pripojenie bez použitia adaptéra na vodiacu lištu







SP6000, DHS900, DHS783, DHS782, DSP601,
DSP600, HS004G, HS009G, HS011G, SP001G

Modely píľ ktoré sa nedajú použiť s adaptérom na vodiacu lištu

5604, 5704, 5143R, N5900B, 5104S, DRS780,
DSS610, RS001G, RS002G, CS002G

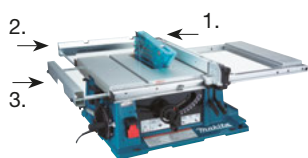

DELENIE: PRÍSLUŠENSTVO PRE STOLNÉ A POKOSOVÉ PÍLY

	model	Obj. č.	MOC s DPH
Vak na prach *****			
	LF1000, LH1040/F, LS0714/F/FL/L, LS1019/L, LS1030N, LS1040/F, LS1045, LS1216/F/FL/L, LS1219/L, LS1221, DLS111, DLS211, LS003g, LS004G, MLS100	122852-0	3,39 €
	LH1201FL, LS1017L, LS1018L	JM23100501	3,29 €
	LS0815F/FL	JM23510010	5,49 €
	LS1440	122330-0	17,89 €
	LS0810, LS1020, LS1030	122351-2	5,99 €
	LS002G	127512-9	cena na vyžiadanie
	uzáver vaku na prach	410602-8	0,54 €
Svorka zvislá			
	DLS713, DLS714, LS0714, LS0714F, LS0714FL, LS0714L	122571-8	9,19 €
	DLS110, DLS111, DLS112, LS1019/L, LS1219/L, LS003G, LS004G	126617-2	25,69 €
	LS1017L, LS1018L, LH1201FL	JM23100502	7,79 €
	LS1040, LS1040F, LH1040, LH1040F	122536-0	14,29 €
	LS1013	122538-6	9,29 €
	LS1016L, LS1216L	122854-6	25,09 €
Svorka vodorovná			
	LS1017L, LS1018L	122930-6	97,29 €
Predĺženie stola			
	DLS110, DLS111, DLS112, LS1019/L	326978-2	5,87 €
	LS1018L, LH1201FL	JM23100500	9,29 €
	LS1040, LS1040F, LH1040/F	123101-8	12,61 €
	LS1219, LS1219L, LS004G, DSL111	327095-1	6,55 €
Uhlový doraz			
	LF1000	122730-4	17,49 €
	2704	127069-0	68,19 €
	2712	JM27110005	36,79 €
Vodiaci doraz			
	LF1000	122729-9	34,49 €
	LH1040/F	122707-9	12,59 €
	LH1200, LH1201	JM23300008	56,49 €
Hadica odsávania			
	LS1019L	123980-4	63,20 €
	LS1219L	126792-4	72,67 €
Ostatné príslušenstvo			
	tyč pre posun materiálu	JM21080290	1,29 €
	žiarovka pre všetky pokosové píly s označením f	193730-1	6,14 €
	nastavovací trojuholník	762001-3	0,79 €
Príslušenstvo pre 2704			
	popis	obj. č.	Moc s DPH
	1. vodiaci doraz	122739-6	176,19 €
	2. predĺženie stola vzadu	194087-3	cena na vyžiadanie
	3. predĺženie stola vľavo	194086-5	51,79 €

DELENIE: PRÍSLUŠENSTVO PRE STOLNÉ A POKOSOVÉ PÍLY

Stôl	model	Obj. č.	MOC s DPH
	LS0714, LS1040, LH1040, LS1013, LS1016, LS108, LS1214, LS1440, 2012NB	198688-9	254,39 €
	2703, 2704, 2704N, 2705	194093-8	541,89 €
	MLT100, MLT100N,	JM27000300	344,09 €
	pre všetky modely stolných a pokosových píľ okrem 2704, LF100	DEAWST05	370,99 €
	pre všetky modely stolných a pokosových píľ okrem 2704, LF100 1170/2700 x 500 x 550/800 mm	DEBWST06	326,39 €
	pre všetky modely stolných a pokosových píľ okrem 2704, LF100 1765/3830 x 750 x 860 mm	DEAWST07	460,99 €
lišta upínacia pre stoly WST06, WST07		JM23610050	91,29 €



Akumulátory
 Odkladacie systémy
 Vrtanie
 Skrutkovanie
 Brúsky
 Pílenie
 Frézovanie
 Brúsenie
 Klince / spony
 Špeciálne stroje
 Vysávanie
 Fény/lampy
 Záhradná
 Ručné náradie
 Ostatné

PRÍSLUŠENSTVO

▣ Priamočiare a chvostové píly

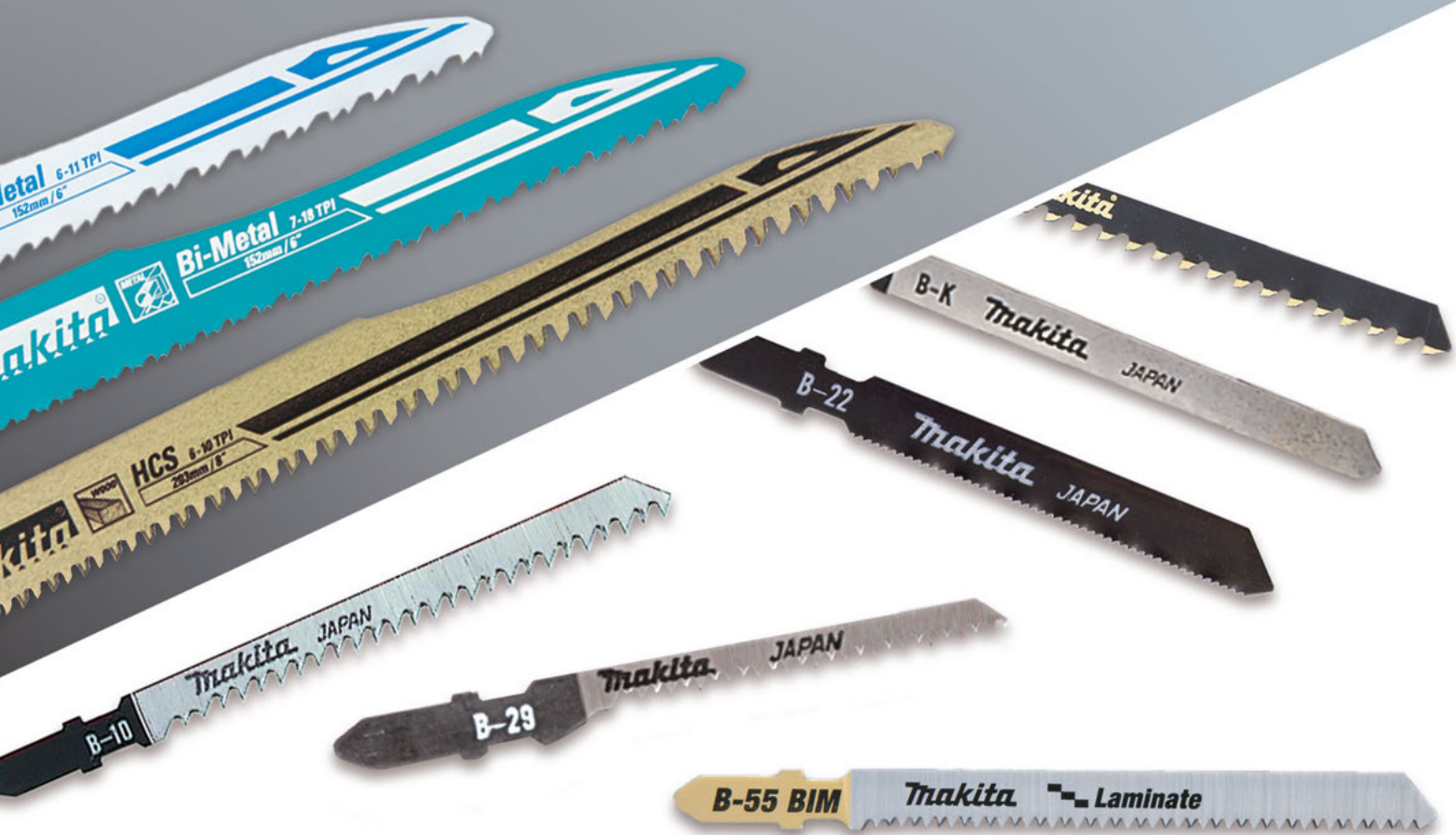

Kov, mäkká oceľ



Neželezné kovy



Laminátové podlahy



Sklolaminát



Nerez



Drevo



Vláknocementová doska



Sadrokartón



Liatina



Drevo s klincami



Pórobetón



HCS



Hliník



Drevotrieska



PVC



Bi-Metal

Typ zubu

frézované bočné zuby

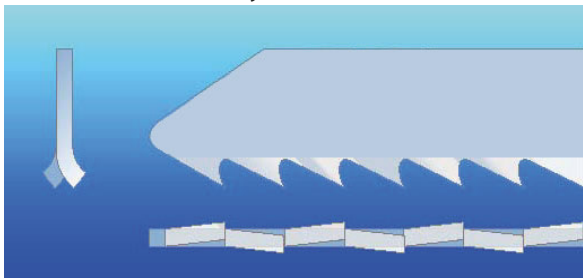

pozdĺžne a bočné zuby

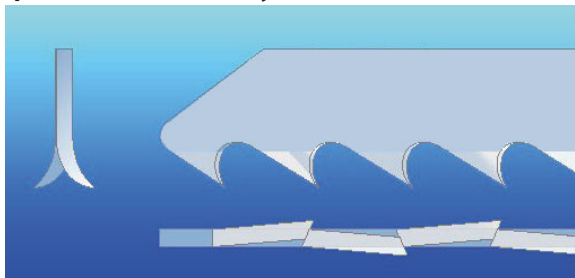

frézované vlnité zuby

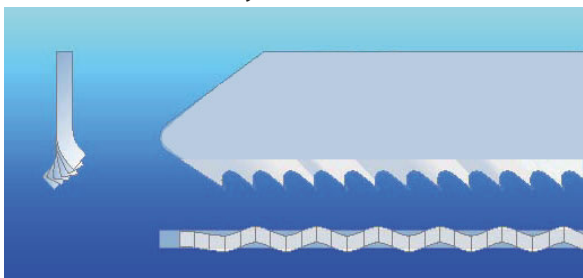

tvrdé kuželovité zuby

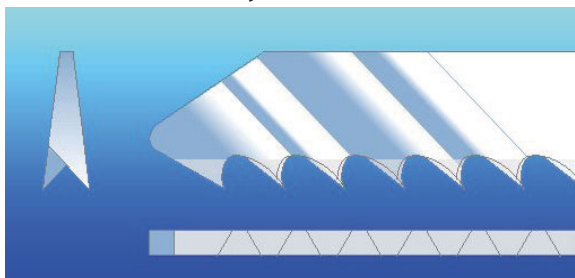

frézované zuby

- pre bežné rezanie
- mäkké až tvrdé materiály
- dlhá životnosť



tvrdé zuby

- veľmi ostré zuby
- presný a čistý rez
- mäkké až stredne tvrdé materiály



Spôsob výroby

- **bočné zuby:** každý jednotlivý zub je striedavo ohnutý doľava a doprava. Príklad: pravá, ľavá, rovná atď.
- **vlnité zuby:** zuby sú tvarované do vlnovky
- **tvrdé zuby:** teleso čepele sa zužuje smerom dozadu (kuželovité)



bočné zuby

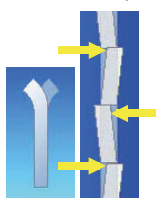

vlnité zuby



tvrdé zuby



Použitie materiálov na výrobu pílových listov

- **HCS (ocel s vysokým obsahom uhlíka)** na rezanie mäkkších materiálov, ako je drevo alebo plasty.
- **HSS (rýchlorezná ocel)** na rezanie tvrdších materiálov, ako sú kovy.
- **BiM (dvojkov /HCS a HSS/)** na rezanie mäkkých materiálov a tvrdých materiálov ako drevo, kovy, plasty.
- **TC (karbid volfrámu)** na rezanie plastov vystužených sklenenými vláknami, cementovo viazaných drevovláknitých dosiek alebo sadrokartónu.

DELENIE: PÍLOVÉ LISTY

List priamočiarej píly B stopka, Drevo Super express



Rozsah	Makita č.	Materiál	Typ rezu	Typ zubu	TPI	Celková dĺžka mm	Pracovná dĺžka mm	Hrúbka listu mm	Materiál listu	Ks / bal.	Obj. č.	MOC s DPH
★★★★☆	B-50	Drevo, PVC	Rýchly a čistý	Kuželovité brúsené zuby	8-11	100	73	1.25	HCS	5	B-06460	6,49 €

List priamočiarej píly B stopka, Kov Super express



Rozsah	Makita č.	Materiál	Typ rezu	Typ zubu	TPI	Celková dĺžka mm	Pracovná dĺžka mm	Hrúbka listu mm	Materiál listu	Ks / bal.	Obj. č.	MOC s DPH
★★★★☆	B-51	Kov, Nerez	Rýchly	Frézované vlnité zuby	10-18	100	73	0.8	HSS	5	B-06476	7,69 €

List priamočiarej píly B stopka, Univerzálny Super express



Rozsah	Makita č.	Materiál	Typ rezu	Typ zubu	TPI	Celková dĺžka mm	Pracovná dĺžka mm	Hrúbka listu mm	Materiál listu	Ks / bal.	Obj. č.	MOC s DPH
★★★★☆	B-52	Univerzálny	Rýchly	Frézované vlnité zuby	6-10	100	73	1.0	HSS	5	B-06482	7,69 €

List priamočiarej píly B stopka, Drevo štandardný rez



Rozsah	Makita č.	Materiál	Typ rezu	Typ zubu	TPI	Celková dĺžka mm	Pracovná dĺžka mm	Hrúbka listu mm	Materiál listu	Ks / bal.	Obj. č.	MOC s DPH
★★★★☆	B-13	Drevo, PVC	Štandardný	Frézované bočne vsadené zuby	8	105	75	1.25	HCS	2	B-01286	cena na vyžiadanie
										5	A-85656	3,99 €
										100	B-07705	73,99 €
	5									A-85662	3,89 €	
	5									A-85678	3,69 €	
B-14	Štandardný	12	76	50	1.05	HCS	5	A-85709	3,99 €			
B-15	Štandardný						100	B-07727	64,99 €			
B-18	Štandardný, Oblúkový	14	77	44	1.05	HCS	100	B-07727	64,99 €			

List priamočiarej píly B stopka, Drevo rýchly rez



Rozsah	Makita č.	Materiál	Typ rezu	Typ zubu	TPI	Celková dĺžka mm	Pracovná dĺžka mm	Hrúbka listu mm	Materiál listu	Ks / bal.	Obj. č.	MOC s DPH						
★★★★☆	B-16	Drevo, PVC	Rýchly	Brúsené bočne vsadené zuby	6	105	75	1.25	HCS	2	B-01292	cena na vyžiadanie						
										5	A-85684	4,79 €						
										100	B-07711	86,89 €						
	B-16L									Rýchly	6	180	151	1.25	HCS	5	792726-5	cena na vyžiadanie
	B-17									Rýchly, Oblúkový	2	B-01301	cena na vyžiadanie					
											5	A-85690	5,29 €					
	B-8									Rýchly	8	105	75	1.25	HCS	5	A-85232	5,99 €
	L-2									Rýchly	6	132	101	1.25	HCS	5	A-86309	7,89 €
No.58	Rýchly	5	A-86577	cena na vyžiadanie														
		100	B-07842	cena na vyžiadanie														

List priamočiarej píly B stopka, Drevo čistý rez



Rozsah	Makita č.	Materiál	Typ rezu	Typ zubu	TPI	Celková dĺžka mm	Pracovná dĺžka mm	Hrúbka listu mm	Materiál listu	Ks / bal.	Obj. č.	
★★★★☆	B-10	Drevo, PVC	Rýchly a čistý	Kuželovité brúsené zuby	9	105	76	1.25	HCS	5	A-85628	5,89 €
										100	B-07674	109,89 €
	B-11				9	100	73	1.25	HCS	2	B-01270	cena na vyžiadanie
										5	A-85634	5,89 €
	B-12				6	105	74	1.25	HCS	5	A-85640	107,59 €
										100	B-07696	113,29 €
	No.59				8	105	75	1.25	HCS	5	A-86583	cena na vyžiadanie
										100	B-07858	cena na vyžiadanie
	B-29				16	77	44	1.05	HCS	5	A-80400	9,70 €
										100	B-07761	116,92 €
L-1	6	132	100	1.25	HCS	5	A-86290	9,59 €				
B-10S	12	90	65	1.25	HCS	5	792691-8	cena na vyžiadanie				
BR-13	9	105	70	1.25	HCS	5	A-85793	4,29 €				
						100	B-07777	77,29 €				

List priamočiarej píly B stopka, Tvrdé drevo a tvrdé plasty, štandardný rez

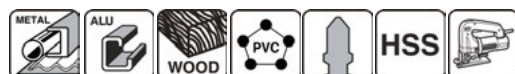

Rozsah	Makita č.	Materiál	Typ rezu	Typ zubu	TPI	Celková dĺžka mm	Pracovná dĺžka mm	Hrúbka listu mm	Materiál listu	Ks / bal.	Obj. č.	MOC s DPH
★★★★☆	B-25	Drevo, PVC, Hliník, Kov	Štandardný	Frézované bočne vsadené zuby	9	100	74	1.05	HSS	2	B-01345	cena na vyžiadanie
										5	A-85765	6,09 €
										100	B-07755	97,29 €
	B-26				9	100	71	1.05	HSS	2	B-01351	cena na vyžiadanie
5		A-85771	7,39 €									

List priamočiarej píly B stopka, Dekoratívne dyhy čistý rez



Rozsah	Makita č.	Materiál	Typ rezu	Typ zubu	TPI	Celková dĺžka mm	Pracovná dĺžka mm	Hrúbka listu mm	Materiál listu	Ks / bal.	Obj. č.	MOC s DPH
★★★★☆	B-19	Drevo, PVC	Čistý	Kuželovité brúsené zuby	12	90	63	1.25	HCS	5	A-85715	5,89 €
	B-28	Drevo, PVC	Čistý		16	90	63	1.25	HSS	5	A-80391	cena na vyžiadanie

List priamočiarej píly B stopka, Laminátové podlahy čistý rez



Rozsah	Makita č.	Materiál	Typ rezu	Typ zubu	TPI	Celková dĺžka mm	Pracovná dĺžka mm	Hrúbka listu mm	Materiál listu	Ks / bal.	Obj. č.	MOC s DPH							
★★★★☆	B-53	Laminátové podlahy, PVC	Čistý	Kuželovité brúsené zuby	15	82	59	1.25	Bi-Metal	5	B-10970	13,19 €							
	Čistý, Oblúkový		18										82	59	1.25	Bi-Metal	5	B-10986	15,29 €
	Čistý		14										100	77	1.25	Bi-Metal	5	B-31887	13,29 €

List priamočiarej píly B stopka, Kov štandardný rez



Rozsah	Makita č.	Materiál	Typ rezu	Typ zubu	TPI	Celková dĺžka mm	Pracovná dĺžka mm	Hrúbka listu mm	Materiál listu	Ks / bal.	Obj. č.	MOC s DPH	
★★★★☆	B-22	Kov, Nerez, PVC, Hliník	Štandardný		24	76	52	0.9	HSS	2	B-01323	cena na vyžiadanie	
										5	A-85737	4,99 €	
										100	B-07733	92,29 €	
	B-23	Drevo, PVC, Hliník, Kov	Štandardný		14	76	51	0.9	HSS	2	B-01339	cena na vyžiadanie	
										5	A-85743	4,89 €	
										100	B-07749	88,89 €	
		B-24	Kov, Nerez, PVC, Hliník	Štandardný	Frézované vlnité zuby	32	76	52	0.9	HSS	5	A-85759	4,79 €
		B-27		Štandardný		24	76	52	0.9	HSS	2	B-01367	cena na vyžiadanie
		B-27		Obľúkový		24	76	52	0.9	HSS	5	A-85787	5,59 €
		B-32		Kov, PVC, Hliník		Štandardný	18	132	107	1.25	HSS	5	B-10431
	B-33	Kov, PVC, Hliník		Štandardný		14	132	107	1.25	HSS	5	B-10447	cena na vyžiadanie
	B-34	Kov, Nerez, PVC, Hliník		Štandardný		18	76	52	0.9	HSS	5	B-10453	cena na vyžiadanie
	B-35	Drevo s klincami, Plastic, Hliník		Štandardný		14	180	154	0.9	Bi-Metal	3	B-10469	cena na vyžiadanie
	No.51	Kov, Nerez, PVC, Hliník	Štandardný		24	90	66	0.9	HSS	5	A-86561	cena na vyžiadanie	
										100	B-07836	cena na vyžiadanie	

List priamočiarej píly B stopka, PVC



Rozsah	Makita č.	Materiál	TPI	Celková dĺžka mm	Pracovná dĺžka mm	Hrúbka listu mm	Materiál listu	Ks / bal.	Obj. č.	MOC s DPH
★★★★☆	B-21	PVC, Hliník	12	100	73	1.25	HSS	5	A-85721	9,29 €

List priamočiarej píly B stopka, Vlákno-cementové dosky



Rozsah	Makita č.	Materiál	TPI	Celková dĺžka mm	Pracovná dĺžka mm	Hrúbka listu mm	Materiál listu	Ks / bal.	Obj. č.	MOC s DPH
★★★★☆	B-60	Vlákno-cementové dosky, Sádrotkartón, Sklolaminát, PVC	6	100	75	1.25	TC/HM	3	B-06890	24,49 €
	B-61	Vlákno-cementové dosky, Sádrotkartón, Sklolaminát, PVC	6	132	105	1.25	TC/HM	3	B-06909	35,29 €

List priamočiarej píly B stopka, Guma



Rozsah	Makita č.	Materiál	Celková dĺžka mm	Pracovná dĺžka mm	Hrúbka listu mm	Materiál listu	Ks / bal.	Obj. č.	MOC s DPH
★★★☆☆	B-K	Guma, Papier, Korok, Koža	100	75	1.25	HCS	5	A-80416	19,49 €

List priamočiarej píly B stopka, Sady



Rozsah	Obsah sady	Ks / bal.	Obj. č.	MOC s DPH
★★★★☆	2xB-13, 2xB-16, 2xB-10S, 2xB-22, 2xB-23	10	B-44410	cena na vyžiadanie
★★★★☆	4xB-50, 2xB-51, 2xB-52, 2xB-53	10	B-44426	cena na vyžiadanie
★★★★☆	2xB-50, B-51, B-52, B-53	5	B-48527	8,19 €
★★★★☆	B-10S, B-13, B-16, B-22, B-23	5	A-86898	4,89 €
★★★★☆	B-50, B-51, B-52	3	B-06292	5,09 €

List priamočiarej píly Makita stopka, Drevo štandardný rez

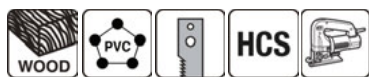

Rozsah	Makita č.	Materiál	Typ rezu	Typ zubu	TPI	Celková dĺžka mm	Pracovná dĺžka mm	Hrúbka listu mm	Materiál listu	Ks / bal.	Obj. č.	MOC s DPH
★★★★☆	No.3	Drevo, PVC	Štandardný	Frézované bočne vsadené zuby	9	80	59	1	HCS	5	A-85868	3,89 €

List priamočiarej píly Makita stopka, Drevo čistý rez



Rozsah	Makita č.	Materiál	Typ rezu	Typ zubu	TPI	Celková dĺžka mm	Pracovná dĺžka mm	Hrúbka listu mm	Materiál listu	Ks / bal.	Obj. č.	MOC s DPH
★★★★☆	BR-3	Drevo	Čistý	Frézované bočne vsadené zuby	9	85	58	1	HCS	5	A-85933	4,49 €
	Č.10	Drevo, PVC	Rýchly a čistý	Kuželovité brúsené zuby	9	82	60	1.25	HCS	5	A-85818	5,69 €

List priamočiarej píly Makita stopka, Dekoratívne dýhy

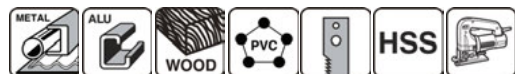

Rozsah	Makita č.	Materiál	Typ rezu	Typ zubu	TPI	Celková dĺžka mm	Pracovná dĺžka mm	Hrúbka listu mm	Materiál listu	Ks / bal.	Obj. č.	MOC s DPH
★★★★☆	No.17	Drevo, PVC, Hliník, Kov	Štandardný, Oblúkový	Frézované bočne vsadené zuby	14	82	63	0.9	HSS	5	A-85846	5,99 €

List priamočiarej píly Makita stopka, Kov štandardný rez

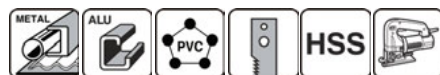

Rozsah	Makita č.	Materiál	Typ rezu	Typ zubu	TPI	Celková dĺžka mm	Pracovná dĺžka mm	Hrúbka listu mm	Materiál listu	Ks / bal.	Obj. č.	MOC s DPH
★★★★☆	No.1	Kov, Nerez, PVC, Hliník	Štandardný	Frézované vlnité zuby	24	80	61	0.9	HSS	5	A-85802	6,19 €

List pre chvostovú pílu, Kov Super express



SUPEREXPRESS



Rozsah	Materiál	Typ rezu	Typ zubu	TPI	Celková dĺžka mm	Pracovná dĺžka mm	Hrúbka listu mm	Materiál listu	Ks / bal.	Obj. č.	MOC s DPH
★★★★☆	Kov, PVC	Rýchly	Frézované bočne vsadené zuby	7-18	152	130	0.9	Bi-Metal	2	B-05038-2	7,39 €
									5	B-05038	16,49 €
									25	B-05038-25	74,19 €

List pre chvostovú pílu, Drevo Super express



SUPEREXPRESS



Rozsah	Materiál	Typ rezu	Typ zubu	TPI	Celková dĺžka mm	Pracovná dĺžka mm	Hrúbka listu mm	Materiál listu	Ks / bal.	Obj. č.	MOC s DPH
★★★★☆	Drevo	Rýchly	Frézované bočne vsadené zuby	6-10	203	180	1.0	HCS	2	B-05153-2	7,69 €
									5	B-05153	17,29 €
									25	B-05153-25	77,69 €

DELENIE: PÍLOVÉ LISTY

List pre chvostovú pílu, Univerzál Super express

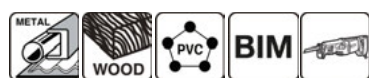

SUPEREXPRESS



Rozsah	Materiál	Typ rezu	Typ zubu	TPI	Celková dĺžka mm	Pracovná dĺžka mm	Hrúbka listu mm	Materiál listu	Ks / bal.	Obj. č.	MOC s DPH
★★★★☆	Univerzálny	Rýchly	Frézované bočne vsadené zuby	6-11	152	130	0.9	Bi-Metal	2	B-05044-2	7,39 €
									5	B-05044	16,89 €
									25	B-05044-25	73,09 €

List pre chvostovú pílu, Kov



Rozsah	Materiál	Typ rezu	Typ zubu	TPI	Celková dĺžka mm	Pracovná dĺžka mm	Hrúbka listu mm	Materiál listu	Ks / bal.	Obj. č.	MOC s DPH	
★★★★☆	Kov	Štandardný	Frézované bočne vsadené zuby	14	152	130	0.9	Bi-Metal	2	B-16841-2	5,49 €	
									5	B-16841	11,69 €	
									25	B-16841-25	cena na vyžiadanie	
									2	B-16776-2	7,89 €	
									5	B-16776	17,69 €	
									25	B-16776-25	cena na vyžiadanie	
				18	152	130	0.9	Bi-Metal	2	B-05169-2	5,49 €	
									5	B-05169	11,69 €	
									25	B-05169-25	cena na vyžiadanie	
									2	B-00810	cena na vyžiadanie	
									5	792147-1	27,80 €	
									2	B-16782-2	7,89 €	
				18	165	144	0.9	HSS	5	B-16782	17,69 €	
									25	B-16782-25	cena na vyžiadanie	
									2	B-16835-2	5,49 €	
									5	B-16835	11,69 €	
									2	B-43169-2	7,89 €	
									5	B-43169	cena na vyžiadanie	
				24	225	205	0.9	Bi-Metal	5	B-20410	11,39 €	
									5	B-20404	11,39 €	
5	B-20395	11,39 €										
2	B-00804	cena na vyžiadanie										
5	792146-3	cena na vyžiadanie										
2	B-00832	cena na vyžiadanie										
24	100	80	0.9	Bi-Metal	5	792149-7	cena na vyžiadanie					
					2	B-16857-2	9,49 €					
					5	B-16857	21,69 €					
					10-14	305	280	0.9	Bi-Metal	2	B-16857-2	9,49 €
					5	B-16857	21,69 €					
					Kov, Hliník, PVC							

List pre chvostovú pílu, Kov tvrdé zuby



Rozsah	Materiál	Typ rezu	Typ zubu	TPI	Celková dĺžka mm	Pracovná dĺžka mm	Hrúbka listu mm	Materiál listu	Ks / bal.	Obj. č.	MOC s DPH
★★★★☆	Kov	Tvrdý a rýchly	Frézované bočne vsadené zuby	14+18	225	205	1.1	Bi-Metal	5	B-43175	20,69 €
				8+10	225	205	1.1	Bi-Metal	5	B-43181	20,69 €
				10-14	305	280	1.1	Bi-Metal	2	B-43212-2	10,49 €
				10-14	225	205	1.25	Bi-Metal	2	B-43197-2	9,09 €

List pre chvostovú pílu, Drevo štandardný rez



Rozsah	Materiál	Typ rezu	Typ zubu	TPI	Celková dĺžka mm	Pracovná dĺžka mm	Hrúbka listu mm	Materiál listu	Ks / bal.	Obj. č.	MOC s DPH
★★★★☆	Drevo	Štandardný	Frézované bočne vsadené zuby	10	152	130	0.8	HCS	5	B-16807	8,79 €
				3	152	130	1.25	HCS	5	B-16813	8,79 €
				6	152	130	1.25	HCS	5	B-16798	8,79 €
				6	305	280	1.25	HCS	2	B-16829-2	6,59 €
				5	305	280	1.25	HCS	5	B-16829	14,49 €
				Green tree, Drevo				5	305	280	1.5

List pre chvostovú pílu, Drevo Rýchly



Rozsah	Materiál	Typ rezu	Typ zubu	TPI	Celková dĺžka mm	Pracovná dĺžka mm	Hrúbka listu mm	Materiál listu	Ks / bal.	Obj. č.	MOC s DPH
★★★☆☆	Drevo	Rýchly	Brúsené bočne vsadené zuby	6	300	279	1.25	HCS	5	B-03030	27,99 €

List pre chvostovú pílu, Drevo a kov štandardný rez



Rozsah	Materiál	Typ rezu	Typ zubu	TPI	Celková dĺžka mm	Pracovná dĺžka mm	Hrúbka listu mm	Materiál listu	Ks / bal.	Obj. č.	MOC s DPH
★★★☆☆	Drevo s klincami	Štandardný	Frézované bočne vsadené zuby	6	100	80	0.9	Bi-Metal	5	B-20432	12,89 €
				6	152	130	1.25	Bi-Metal	2	B-05175-2	6,39 €
	Drevo, Drevotrieska, Drevo s klincami, Kov, Pórobetón, PVC, Sklolaminát		5-8	305	280	1.25	Bi-Metal	3	B-10637	15,69 €	
	Drevo, Kov		Štandardný	Frézované bočne vsadené zuby	10	100	80	0.9	Bi-Metal	5	B-20426
14+18		100			80	0.9	Bi-Metal	5	B-20454	12,89 €	
10		152			130	0.9	Bi-Metal	5	B-31843	11,69 €	
Drevo, Drevo s klincami, Kov			10	225	205	0.9	Bi-Metal	5	B-31859	17,89 €	

List pre chvostovú pílu, Drevo a kov tvrdé zuby



Rozsah	Materiál	Typ rezu	Typ zubu	TPI	Celková dĺžka mm	Pracovná dĺžka mm	Hrúbka listu mm	Materiál listu	Ks / bal.	Obj. č.	MOC s DPH
★★★☆☆	Drevo, Drevotrieska, Kov	Heavy	Frézované bočne vsadené zuby	5-8	225	205	1.6	Bi-Metal	2	B-43256-2	11,89 €
				5-8	305	280	1.6	Bi-Metal	2	B-43278-2	13,69 €

List pre chvostovú pílu, Liatinové rúry



Rozsah	Materiál	TPI	Celková dĺžka mm	Pracovná dĺžka mm	Hrúbka listu mm	Materiál listu	Ks / bal.	Obj. č.	MOC s DPH
★★★☆☆	Kov, Liatina, Nerez	8	100	80	1.25	TC/HM	1	B-55566	11,99 €
			150	130	1.25	TC/HM	1	B-55572	17,39 €
			228	205	1.25	TC/HM	1	B-55588	21,39 €
			305	280	1.25	TC/HM	1	B-55594	26,59 €
★★★☆☆	Liatina, Sklolaminát, Epoxidy	-	225	205	1	Diamond Grit	2	B-31871	45,09 €

Zuby z karbidu volfrámu



30 krát vyššia životnosť BIM plátok

Použite



Pre liatinu



Pre nerez

DELENIE: PÍLOVÉ LISTY

List pre chvostovú pílu, Nerez



Rozsah	Materiál	TPI	Celková dĺžka mm	Pracovná dĺžka mm	Hrúbka listu mm	Materiál listu	Ks / bal.	Obj. č.	MOC s DPH
★★★☆☆	Nerez	18	152	128	1	TC/HM	2	B-07250	33,09 €

List pre chvostovú pílu, Izolačné materiály



Rozsah	Materiál	Celková dĺžka mm	Pracovná dĺžka mm	Hrúbka listu mm	Materiál listu	Ks / bal.	Obj. č.	MOC s DPH
Špeciálny	Izolačné materiály	400	320	1.5	HCS	1	B-52130	31,59 €

List pre chvostovú pílu, Sádrokartón štandardný rez



Rozsah	Materiál	Typ rezu	Typ zubu	TPI	Celková dĺžka mm	Pracovná dĺžka mm	Hrúbka listu mm	Materiál listu	Ks / bal.	Obj. č.	MOC s DPH
★★★☆☆	Sádrokartón	Štandardný	Frézované bočne vsadené zuby	6	100	80	0.9	Bi-Metal	5	B-20448	12,89 €

List pre chvostovú pílu, Mrazené potraviny



Rozsah	Materiál	Typ rezu	Typ zubu	TPI	Celková dĺžka mm	Pracovná dĺžka mm	Hrúbka listu mm	Materiál listu	Ks / bal.	Obj. č.	MOC s DPH
Špeciálny	Ice	Štandardný	Frézované bočne vsadené zuby	10	228	207	1.2	Nerez steel	1	B-30570	21,49 €
				10	305	279	1.2	Nerez steel	1	B-23254	25,09 €
		Hrubý		3	305	280	1.25	Nerez steel	1	B-10609	9,09 €
				6	152	131	1.2	Nerez steel	1	B-52043	23,59 €
				6	228	207	1.2	Nerez steel	1	B-30564	21,39 €
				6	305	279	1.2	Nerez steel	1	B-23248	25,29 €

List pre chvostovú pílu, Tehly a porobetón

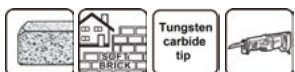

Rozsah	Materiál	TPI	Celková dĺžka mm	Pracovná dĺžka mm	Hrúbka listu mm	Materiál listu	Ks / bal.	Obj. č.	MOC s DPH
★★★☆☆	Pórobetón, Mäkká tehla	2	305	267	1.5	TC/HM	1	B-10394	38,59 €
		2	455	420	1.5	TC/HM	1	B-10403	53,79 €
	Pórobetón, Mäkká tehla, Epoxidy	2	400	375	1.5	TC/HM	2	B-63591	54,99 €
		3	305	280	1.5	TC/HM	2	B-63585	41,59 €

Pílové listy pre pásové píly s dĺžkou pásu 835 mm, vlnité zuby

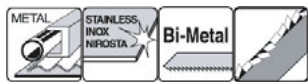

Dĺžka mm	Typ zuba	Materiál	Materiál listu	Tpi	Popis	Rozsah	Ks / bal.	Obj.č.	MOC s DPH
835	Vlnitý	PVC, nežeľezné kovy, mäkká oceľ liatina, tvrdá oceľ, nerez	BiM	14	Hrúbka materiálu: viac ako 5 mm	★★★	5	B-40543	52,49 €
				18	Hrúbka materiálu: 4 – 5 mm	★★★	5	B-40559	52,49 €
				24	Hrúbka materiálu: menej ako 4 mm	★★★	5	B-40565	52,19 €

Pílové listy pre pásové píly s dĺžkou pásu 1140 mm, bočné zuby



Dĺžka mm	Typ zuba	Materiál	Materiál listu	Tpi	Popis	Rozsah	Ks / bal.	Obj.č.	MOC s DPH
1140	Bočné	PVC, nežeľezné kovy, mäkká oceľ	HCS	14	Hrúbka materiálu: viac ako 5 mm	★★★	3	792560-3	37,19 €
				18	Hrúbka materiálu: 4 – 5 mm	★★★	3	792559-8	36,19 €
				24	Hrúbka materiálu: menej ako 4 mm	★★★	3	792558-0	37,79 €
		PVC, nežeľezné kovy, mäkká oceľ liatina, tvrdá oceľ, nerez	BiM	10	Hrúbka materiálu: viac ako 5,5 mm	★★★	1	B-30128	21,59 €
				14	Hrúbka materiálu: viac ako 5 mm	★★★	1	792557-2	23,29 €
				18	Hrúbka materiálu: 4 – 5 mm	★★★	1	792556-4	22,09 €

Pílové listy pre pásové píly s dĺžkou pásu 1140 mm, vlnité zuby

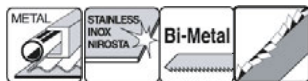

Dĺžka mm	Typ zuba	Materiál	Materiál listu	Tpi	Popis	Rozsah	Ks / bal.	Obj.č.	MOC s DPH
1140	Vlnitý	PVC, nežeľezné kovy, mäkká oceľ liatina, tvrdá oceľ, nerez	BiM	24	Hrúbka materiálu: menej ako 4 mm	★★★	1	194692-6	22,99 €

Pílové listy pre pásové píly s dĺžkou pásu 1140 mm, bočné zuby



Dĺžka mm	Typ zuba	Materiál	Materiál listu	Tpi	Rozsah	Ks / bal.	Obj.č.	MOC s DPH
1140	Bočné	Drevo	HCS	6	★★★	3	792567-9	37,39 €

Pílové listy pre pásové píly s dĺžkou pásu 2240 mm, bočné zuby







Dĺžka mm	Typ zuba	Materiál	Materiál listu	Tpi	Popis	Rozsah	Ks / bal.	Obj.č.	MOC s DPH
2240	Bočné	Nežeľezné kovy	HCS	14	Hrúbka materiálu: viac ako 5 mm	★★★	3	B-16695	67,99 €

Pílové listy pre pásové píly s dĺžkou pásu 2240 mm, bočné zuby



Dĺžka mm	Typ zuba	Materiál	Materiál listu	Tpi	Rozsah	Ks / bal.	Obj.č.	MOC s DPH
2240	Bočné	Drevo, priečny rez	HCS	4	★★★	3	B-16667	63,59 €
		Drevo, oblúkový rez	HCS	6	★★★	3	B-16689	52,09 €
		Drevo, univerzálny rez	HCS	4	★★★	3	B-16673	51,09 €

DELENIE: PRÍSLUŠENSTVO PRE PRIAMOČIARE PÍLY

	model	Obj. č.	MOC s DPH
Odsávací adaptér *****			
	DJV180, 4350T/CT/FCT, 4351T/CT/FCT	417853-4	0,79 €
	DJV181, DJV182	126331-0	4,49 €
Plastová klzná doska			
	DJV180, DJV181, DJV182, JV100D, JV183D 4350CT/FCT, 4351CT/FCT	417852-6	1,15 €
Chránič proti vytrhávaniu materiálu			
	DJV180, DJV181, DJV182, JV100D, JV101D, JV102D, JV103D, 4326, 4327, 4329, 4350T/CT/FT/FCT, 4351T/CT/FCT, JV0600	415524-7	0,29 €
Adaptér k vodiacim lištám Makita			
	JV100D, JV101D, JV102D, JV103D, JV143D, JV183D 4326, 4327/M, 4328, 4329, JV0600 DJV180, DJV181, DJV182, 4350T/CT/FCT, 4351T/CT/FCT	193517-1	25,39 €
Doraz na vyrezávanie kruhov			
	JV100D, JV101D, JV102D, JV103D, JV143D, JV183D 4326, 4327/M, 4328, 4329, JV0600 DJV180, DJV181, DJV182, 4350T/CT/FCT, 4351T/CT/FCT	192732-4	6,79 €

	model	Popis	Obj. č.	MOC s DPH
Príslušenstvo pre pásové píly *****				
	DPB181, DPB182,	kryt pílového pásu	197975-3	31,96 €
	všetky modely	rezací vosk	191897-9	15,09 €
	DPB183	rukoväť	158237-4	2,89 €
Prepravné kufre				
	DJV180, DJV181, DJV182, JV100D,	PVC	141486-0	38,89 €
	4350FC/FCT, 4351FC/FCT	PVC	824809-4	23,79 €



DELENIE: PRÍSLUŠENSTVO PRE HOBLÍKY

model	Obj. č.	MOC s DPH
Mierka na nastavenie nôžov *****		
DKP180, DKP181, KP0800, KP0810/C, N1900B, N1923B, 1002BA, 1100, 1902, 1911B, 1912B, KP001G	123062-2	15,29 €
2012NB	762016-0	5,19 €
Nástrčný kľúč 9		
DKP180, DKP181, KP312, KP0800, KP001G, KP0810/C, N1900B, N1923B, 1002BA, 1100, 1804N, 1805N, 1806B, 1902, 1911B, 1912B	782209-3	2,19 €
Prítlačná doštička		
DKP180, DKP181, KP0800, KP0810/C, N1900B, N1923B, 1100, 1902	A-86175	5,24 €
KP312/S	345328-2	40,50 €
Držiak noža na brúsenie		
DKP180, DKP181, KP0800, KP0810/C, N1900B, N1923B, 1100, 1902, KP001G	123004-6	4,49 €
1804N, 1805N, 1806B	123006-2	6,39 €
1002BA, 1911B, 1912B	123055-9	3,39 €
Paralelný doraz		
KP0800, DKP180, N1923B, MT191, M1901, M1902	165581-2	6,59 €
DKP181, KP810/C, KP001G	122785-2	cena na vyžiadanie
1806B	123053-3	14,09 €
Paralelný doraz pre bočné vedenie		
KP0810, KP0810C, DKP181, KP001G	122791-4	30,59 €
Skrutka zaistovania paralelného dorazu		
DKP180, DKP181, KP0800, KP810/C	265785-7	0,38 €
Odsávacie adaptéry		
DKP180, DKP181, KP0800, KP810/C, KP001G	416368-8	2,09 €
Adaptér na odsávaciu hadicu ø 45 mm		
1806, KP312S	181575-9	6,49 €
DKP180, KP0800, KP0810/C	451329-1	2,39 €
Vak na prach		
1902	STEX122269	43,69 €
DKP180, KP0800, KP0810/C, DKP181, KP001G	122793-0	25,89 €
DKP181	191C21-2	cena na vyžiadanie
Plastový kufrík		
KP0800	824892-1	19,29 €
KP0810/C	824786-0	50,59 €
Príslušenstvo ku 2012NB		
držiak s magnetom	762014-4	4,29 €
nastaviteľná doska pre nôž	343692-5	12,41 €
skrutka noža M4 x 6	922103-9	0,31 €
odsávací nástavec	193036-7	21,69 €
(bez možnosti pripojenia k vysávačom Makita)		

model	dĺžka (mm)	materiál	ks/bal	Obj. č.	MOC s DPH
Nože *****					
N1923B/H	82	HSS	set 2 ks	D-16346	7,89 €
KP0810/C, KP001G					
KP0800	82	TC	set 2 ks	D-07967	17,19 €
DKP180/181					
1911B	110	TC	set 2 ks	D-08822	28,09 €
1806	170	HSS	set 2 ks	D-63666	29,29 €
2012NB	306	HSS	set 2 ks	199911-5	110,19 €

Nože obojstranné *****					
N1923B/H	82	TC	set 2 ks	D-07945	12,39 €
KP0810/C					
KP0800	82	TC	set 5ks	D-35302	51,79 €
DKP180/181					
	82	TC	set 2 ks D-07945, 1 ks D-07967 + platnička	D-07951	12,49 €
KP312/S	312	HSS	set 2 ks	B-02870	46,19 €
2012NB	306	HSS	set 2 ks	793346-8	47,29 €

Brúsný kameň

veľkosť (mm)	zrornosť	obj. č.	MOC s DPH
150	WA1200	794061-7	12,69 €
180	WA1200	794060-9	14,39 €



popis	šírka (mm)	Obj. č.	MOC s DPH
Dlabačka 7104L *****			
dlabacia reťaz	21	A-16592	513,49 €
vodiaca lišta	15 - 24	133571-3	175,20 €



D (mm)	L (mm)	OL (mm)	stopka (mm)	Obj. č.	MOC s DPH
--------	--------	---------	-------------	---------	-----------

TCT drážkovacia fréza



Prírodne a ručne opracované dreva a plasty.
Táto séria lícovacích fréz sa môže používať na profilovanie, lícovanie, drážkovanie, vyrezávanie otvorov, rýh a zahlbovanie do širokej palety rôznych materiálov.
Táto paleta lícovacích fréz kombinuje kvalitu, spoľahlivosť a výkonnosť. Sú vyrobené z karbidu volfrámu, ktorý zabezpečuje dlhšiu životnosť fréz.

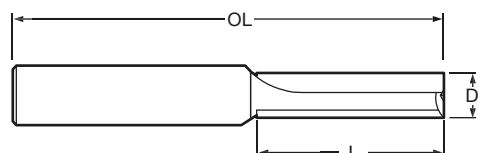

3	10	42	8	P-78689	37,99 €
4	10	42	8	P-78695	37,69 €
5	16	51	8	P-78704	38,29 €
6	16	51	8	P-78710	33,39 €
6	23	58	8	P-78726	40,69 €
8	20	52	8	P-78732	40,69 €
10	20	52	8	P-78760	47,39 €
12	20	52	8	P-78776	48,29 €
12	25	67	12	P-78748	54,79 €
12	50	92	12	P-78754	80,59 €

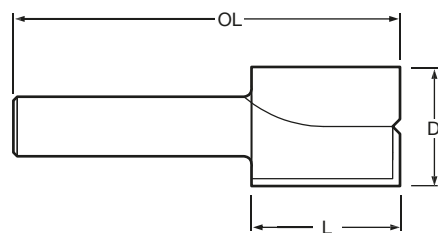

14	20	52	8	P-78782	45,49 €
15	20	52	8	P-78798	51,89 €
16	20	52	8	P-78807	52,59 €
18	20	52	8	P-78813	54,09 €
20	20	52	8	P-78829	56,19 €
24	20	52	8	P-78835	49,69 €
25	20	52	8	P-78841	55,19 €



TCT žliabkovacia fréza s ložiskom



Prírodné a ručne opracované drevo a plasty.
Dva tvary produkované jednou frézou pomocou výmeny ložiska. Ložisko B16 odstraňuje drážky. Väčšie ložiská sú menej náchylné na vznik tepla a majú dlhšiu životnosť ako malé ložiská.

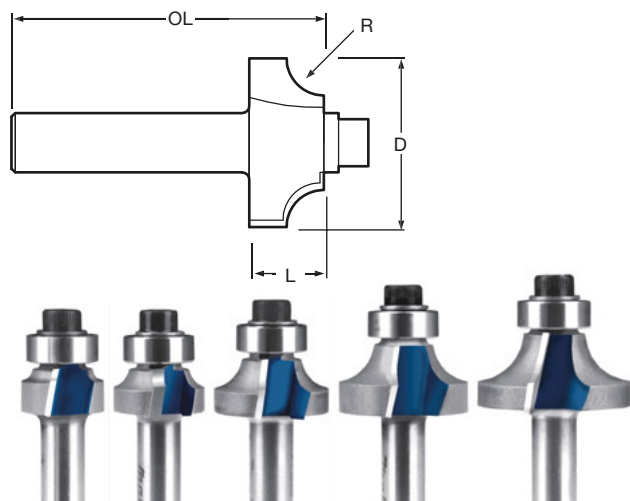

D (mm)	R (mm)	L (mm)	OL (mm)	stopka (mm)	Obj. č.	MOC s DPH
16,7	2	8	40	8	P-78857	46,19 €
18,7	3	8	40	8	P-78863	50,99 €
22	5	10	42	8	P-78879	51,59 €
25	6,3	12,7	45	8	P-78885	49,89 €
28,35	8	13	45	8	P-78891	44,39 €
31,7	9,5	15,8	48	8	P-78900	61,69 €

Tvary dosiahnuté pomocou zaoblňovacích fréz.

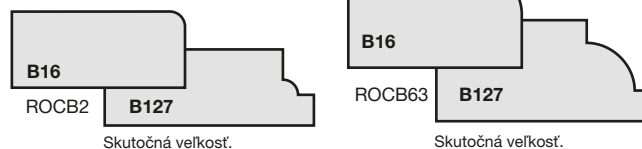

D (mm)	d (mm)	R (mm)	L (mm)	OL (mm)	stopka (mm)	Obj. č.	MOC s DPH
18,7	12,7	2	8	40	6	P-78916	56,49 €
20	12,7	3	9	41	6	P-78922	52,79 €

TCT zaoblňovacia fréza s ložiskom



Prírodné a ručne opracované drevo a plasty.
Táto séria obrysových fréz sa môže používať na profilovanie a vyhladzovanie profilov. Vďaka karbidovým hrotom je možné tieto frézy používať na širokú paletu rôznych materiálov. Táto séria je vyrábaná s menšími priermi.

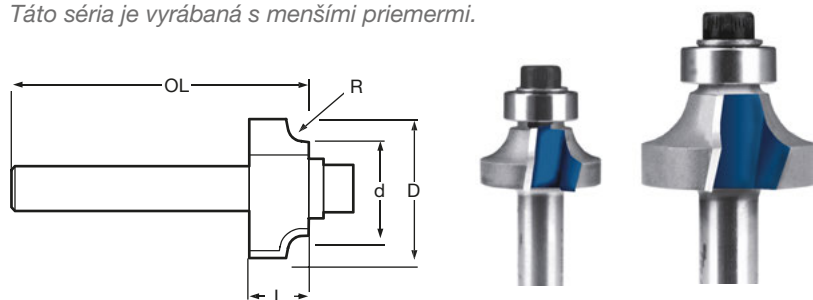

D (mm)	K (mm)	stopka (mm)	Obj. č.	MOC s DPH
40	4	8	P-79120	61,29 €

TCT škárovacia fréza (Biskvit)



Prírodné a ručne opracované drevo a plasty.
Umožňuje frézovanie biskvitových spojovacích štrbín do drevotriesky, MDF a tvrdých drev pomocou ručnej frézy.

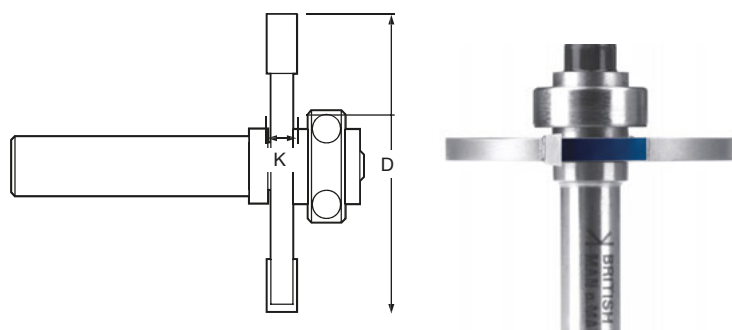

40	4	8	P-79120	61,29 €
----	---	---	---------	---------

FRÉZOVANIE

TCT žliabkovacia fréza

Prírodné a ručne opracované drevo a plasty.
Kompletná séria fréz s možnosťou zahĺbenia s horným rezom. Väčšina fréz je kompatibilná so sériou používanou pri linkových spojoch.

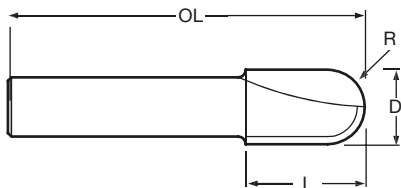

D (mm)	R (mm)	L (mm)	OL (mm)	stopka (mm)	Obj. č.	MOC s DPH
10	5	16	48	8	P-78950	37,59 €
12,7	6,3	17	49	8	P-78966	39,59 €
16	8	18	50	8	P-78972	42,79 €
20	10	18	50	8	P-78944	50,79 €

TCT profilová fréza (vnútorný úkos)

Prírodné a ručne opracované drevo a plasty.
Umožňuje vytváranie pravouhlých rámov. Po zostavení a pri čapovaní sa nevyžaduje líčovanie.

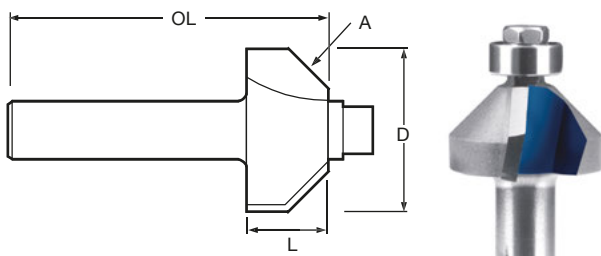

D (mm)	A°	L (mm)	OL (mm)	stopka (mm)	Obj. č.	MOC s DPH
22	45	11	43	8	P-79083	44,99 €

TCT falcovacia fréza (Fréza na poldrážku)

Prírodné a ručne opracované drevo a plasty.

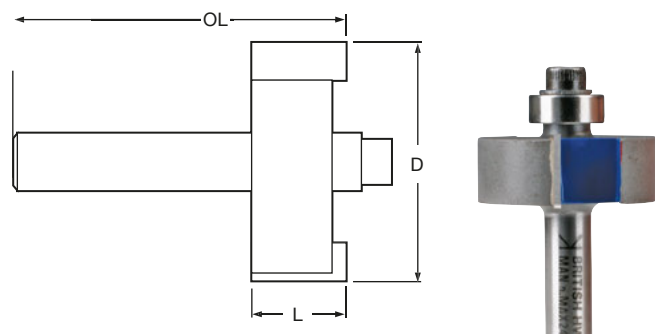

D (mm)	L (mm)	OL (mm)	stopka (mm)	Obj. č.	MOC s DPH
32	12,7	44	8	P-79136	32,89 €

TCT fazetová fréza s ložiskom (fréza na vyduté panely)

Prírodné a ručne opracované drevo a plasty.
Panelové frézy na profilovanie alebo drážkovanie
dekoratívnych šablón a panelov.
Vynikajúce pre čelá zásuviek.

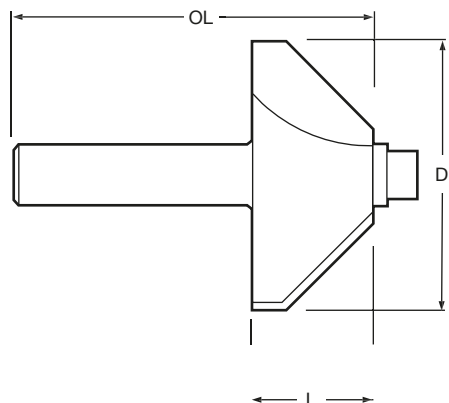

D (mm)	L (mm)	OL (mm)	stopka (mm)	Obj. č.	MOC s DPH
36	16	49	8	P-79099	43,49 €



TCT zarovnávací fréza (fréza na vodiace hrany)

Prírodné a ručne opracované drevo a plasty.
Fréza s dlhšou životnosťou. Mimoriadne populárne
frézy na frézovanie umakartu a laminátu.

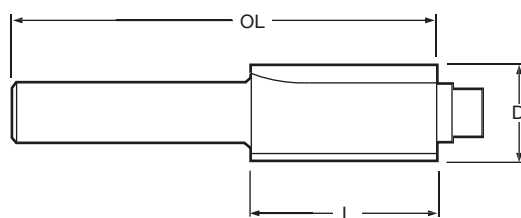

D (mm)	L (mm)	OL (mm)	stopka (mm)	Obj. č.	MOC s DPH
12,71	38,1	86	12	P-78994	49,39 €
12,7	25,4	57	8	P-79005	43,79 €
9,5	25	57	8	P-79011	44,09 €



TCT zarovnávací fréza (Fréza na vodiace hrany, malé priemery)

Prírodné a ručne opracované drevo a plasty.
Vhodné na vyrezávanie otvorov a dier v karavonoch
a v priemysle mobilných domov.

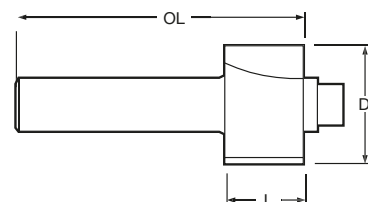

D (mm)	L (mm)	OL (mm)	stopka (mm)	Obj. č.	MOC s DPH
18	50	98	12	P-79027	68,29 €
18	12	50	8	P-78988	35,69 €



FRÉZOVANIE

TCT žliabkovacia fréza s ložiskom

TCT žliabkovacia fréza

Prírodne a ručne opracované drevo a plasty. Táto séria obrysových fréz sa môže používať na profilovanie a úpravu hladkých povrchov na profile. Tieto frézy sa môžu vďaka karbidovým špičkám používať na rôzne druhy materiálov. Táto séria sa vyrába s menším priemerom.

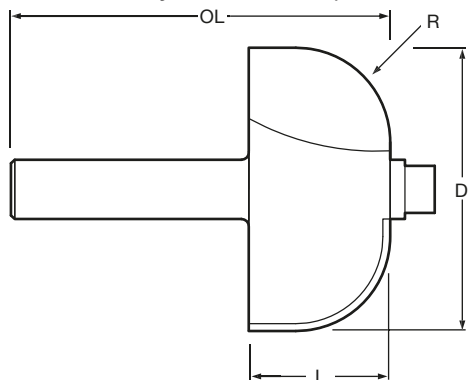

D (mm)	R (mm)	L (mm)	OL (mm)	stopka (mm)	Obj. č.	MOC s DPH
--------	--------	--------	---------	-------------	---------	-----------



38,2	12,7	19	51	8	P-78938	33,19 €
------	------	----	----	---	---------	---------

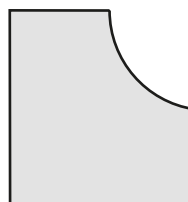

Dodávané s ložiskami B 127 a B 16.

Tvar dosiahnutý pomocou frézy.

CMC127 – Aktuálna veľkosť

Frézovacie vrtáky

Priemer (mm)	Celková dĺžka (mm)	Pracovná dĺžka (mm)	Obj. č.	MOC s DPH
3,18	64	33	191G69-8	2,49 €
6,35	85	40	193447-6	18,29 €

Ložiská pre frézy

objednávacie číslo frézy	typ ložiska	objednávacie číslo frézy	typ ložiska	objednávacie číslo frézy	typ ložiska	objednávacie číslo frézy	typ ložiska
P-78857	B127/B95	P-78916	B127	P-79011	B95/3.175	P-79083	B95/3.175
P-78863	B127/B95	P-78922	B127	P-79027	B18	P-79099	B127
P-78879	B127/B95	P-78938	B127	P-79033	B16/8	P-79120	B15
P-78885	B127/B95	P-78988	B18	P-79049	B16/8	P-79136	B127
P-78891	B127/B95	P-78994	B127	P-79055	B19/127		
P-78900	B127/B95	P-79005	B127	P-79077	B16		

Ložiská pre frézy

typ ložiska	popis	objednávacie číslo	cena s DPH
B127	D=12,7 d=6,35 H=4,8	P-79245	7,59 €
B16	D=16 d=6,35 H=5	P-79267	10,49 €

D – vonkajší priemer
d – vnútorný priemer
H – výška

TCT profilová vodiaca fréza s ložiskom



Prírodne a ručne opracované drevo a plasty. Sériá PGC fréz je vyrábaná s centrálnymi hrotmi a je ideálna na slepé profilovanie a zahlbovanie napríklad pri dvojvrstvovej lepenke. Tieto frézy majú vodiace ložiská určené na elimináciu hornej montážnej šablóny.

D (mm)	L (mm)	OL (mm)	stopka (mm)	Obj. č.	MOC s DPH
19	50	96	12	P-79055	87,29 €
16	25	72	8	P-79049	63,79 €
16	20	67	8	P-79033	65,89 €

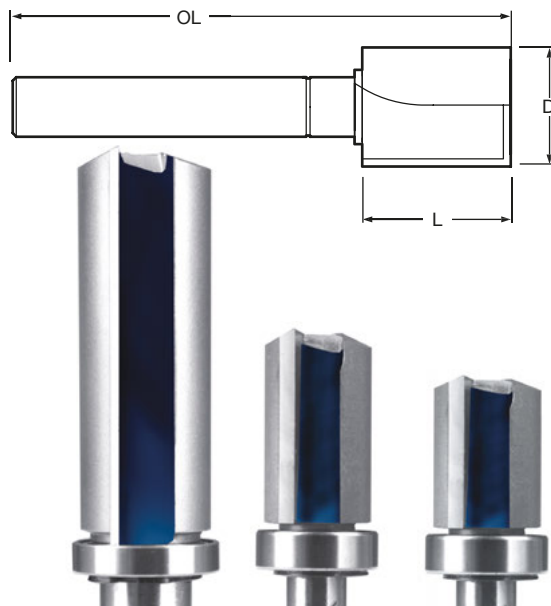

V porovnaní so sekačkou má séria s vodiacim profilom tú výhodu, že je schopná prechádzať cez vrstvu, ktorá má byť osekaná.

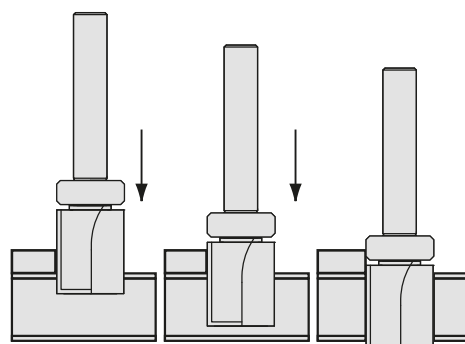

TCT rybinová fréza



Prírodne a ručne opracované drevo a plasty. Štandardná veľkosť pre všetky aplikácie, napríklad frézovanie na rybinu, skrytú rybinu atď. K dispozícii s rysovacími ihlami (na vyžiadanie), čo umožňuje ich používanie spoločne s prenosnými vodiacimi prípravkami.

D (mm)	A°	L (mm)	OL (mm)	stopka (mm)	Obj. č.	MOC s DPH
12	10	10	42	8	P-79108	35,19 €
20	10	16	48	8	P-79114	47,99 €

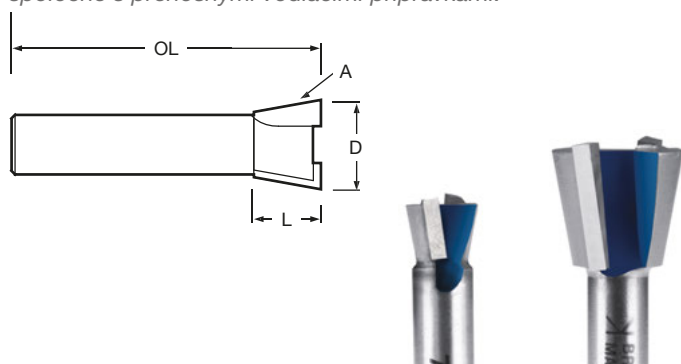

FRÉZOVANIE

D (mm)	L (mm)	OL (mm)	stopka (mm)	Obj. č.	MOC s DPH
--------	--------	---------	-------------	---------	-----------

TCT profilová fréza (drážkovanie – veľký prierez)



Prírodné a ručne opracované drevo a plasty.
Panelové frézy na profilovanie alebo drážkovanie dekoratívnych tvarov a panelov. Dokonalé na čelá zásuviek.

12,7	10	47	8	P-79061	51,89 €
------	----	----	---	---------	---------

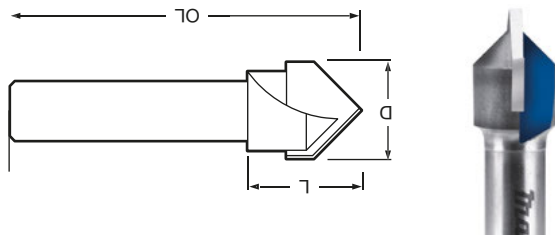

TCT fazetová fréza s ložiskom (na hrany)



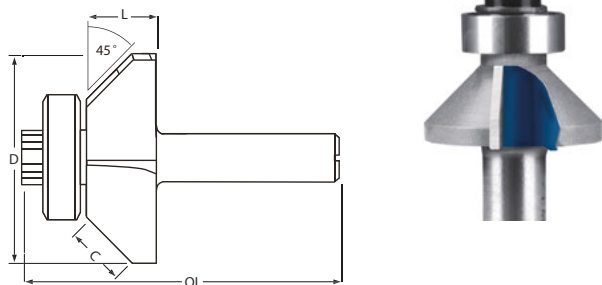

Prírodné a ručne opracované drevo a plasty.
Táto fréza je najefektívnejšia na tvorbu sklonu a orezávanie plastov a laminátu.

24	9	41	8	P-79077	45,19 €
----	---	----	---	---------	---------







FRÉZOVANIE

	priemer (mm)	dĺžka (mm)	celková dĺžka (mm)	rádius (mm)	hĺbka rezu (mm)	uhol (dg)	stopka (mm)	veľkosť ložiska (mm)	max. otáčky (rpm)	Obj. č.	MOC s DPH
TCT profilová vodiaca fréza											
	3	13	51	-	-	-	8	-	28000	D-47379	7,69 €
	4	13	51	-	-	-	8	-	28000	D-47385	8,09 €
	5	13	48	-	-	-	8	-	28000	D-47391	7,19 €
	6	19	50,8	-	-	-	8	-	28000	D-47400	7,49 €
	6	19	50,8	-	-	-	6	-	28000	D-47416	7,89 €
	6	16	48	-	-	-	6	-	28000	D-47422	7,89 €
	6	25	57	-	-	-	6	-	24000	D-47438	8,19 €
	8	19	51	-	-	-	6	-	28000	D-47444	8,69 €
	8	25,4	57,4	-	-	-	6	-	24000	D-47450	8,29 €
	10	25,4	57,4	-	-	-	6	-	24000	D-47466	8,39 €
	12	32	64	-	-	-	6	-	24000	D-47472	10,69 €
	14	19	51	-	-	-	6	-	24000	D-47488	9,69 €
	20	19	51	-	-	-	6	-	24000	D-47494	12,99 €
	6	16	48	-	-	-	8	-	28000	D-47503	7,59 €
	6	19	51	-	-	-	8	-	28000	D-47519	8,09 €
	8	19	51	-	-	-	8	-	28000	D-47525	8,79 €
	10	19	51	-	-	-	8	-	28000	D-47531	9,19 €
	12	19	51	-	-	-	8	-	28000	D-47547	8,69 €
	14	19	51	-	-	-	8	-	24000	D-47553	10,19 €

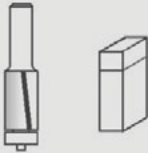

Akumulátory
 Odkladacie systémy
 Vrtanie
 Skrutkovanie
 Brúsky
 Pílenie
 Frézovanie
 Brúsenie
 Klince / spony
 Špeciálne stroje
 Vysávanie
 Fény/lampy
 Záhrada
 Ručné náradie
 Ostatné

FRÉZOVANIE





	priemer (mm)	dĺžka (mm)	celková dĺžka (mm)	rádius (mm)	hĺbka rezu (mm)	uhol (dg)	stopka (mm)	veľkosť ložiska (mm)	max. otáčky (rpm)	Obj. č.	MOC s DPH
TCT profilová vodiaca fréza											
	16	19	51	-	-	-	8	-	24000	D-47569	11,69 €
	18	19	51	-	-	-	8	-	24000	D-47575	12,69 €
	20	19	51	-	-	-	8	-	24000	D-47581	13,19 €
	22	25,4	57,2	-	-	-	8	-	24000	D-47597	14,09 €
	24	25,4	57	-	-	-	8	-	24000	D-47606	17,39 €
	8	25	70	-	-	-	12	-	24000	D-47612	9,39 €
	10	25,4	70	-	-	-	12	-	24000	D-47628	9,59 €
	12	32	73	-	-	-	12	-	24000	D-47634	11,79 €
	14	32	73	-	-	-	12	-	24000	D-47640	12,29 €
	16	32	73	-	-	-	12	-	24000	D-47656	13,09 €
	19	32	73	-	-	-	12	-	24000	D-47662	16,69 €
	22	32	73	-	-	-	12	-	24000	D-47678	17,39 €
	25	32	73	-	-	-	12	-	18000	D-47684	18,39 €
		9,5	26	66,9	-	-	-	6	9,5	24000	D-47690
12,7		13	56	-	-	-	6	12,7	28000	D-47709	8,99 €
12,7		26	68,5	-	-	-	6	12,7	24000	D-47715	9,89 €
9,5		26	67	-	-	-	8	9,5	24000	D-47721	9,59 €
12,7		13	55,7	-	-	-	8	12,7	28000	D-47737	9,89 €
12,7		26	68,5	-	-	-	8	12,7	24000	D-47743	10,59 €
	12,7	26	68,5	-	-	-	8	12,7	24000	D-47759	14,29 €
	12,7	38	91,4	-	-	-	12	12,7	24000	D-47765	17,09 €
	6,35	19	65	-	-	-	6	-	28000	D-47771	7,79 €
	6,35	19	65	-	-	-	8	-	28000	D-47787	7,79 €
	9,5	26	75	-	-	-	12	-	24000	D-47793	10,29 €
	6,35	12,7	44,5	3,2	-	-	6	-	28000	D-47802	7,39 €
	9,5	12,7	44,5	4,8	-	-	6	-	28000	D-47818	8,39 €
	12,7	19	51	6,35	-	-	6	-	28000	D-47824	12,29 €
	6,35	12,7	44,5	3,2	-	-	8	-	28000	D-47830	6,69 €
	9,5	12,7	44,5	4,8	-	-	8	-	28000	D-47846	8,39 €
	12,7	19	51	6,35	-	-	8	-	28000	D-47852	12,39 €

FRÉZOVANIE

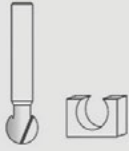

	priemer (mm)	dĺžka (mm)	celková dĺžka (mm)	rádius (mm)	hlĺbka rezu (mm)	uhol (dg)	stopka (mm)	veľkosť ložiska (mm)	max. otáčky (rpm)	Obj. č.	MOC s DPH
TCT profilová vodiaca fréza											
	12,7	12,7	44,7	-	-	90dg	6	-	28000	D-47868	8,99 €
	12,7	16	48	-	-	60dg	6	-	28000	D-47874	9,29 €
	19	16	47,6	-	-	90dg	6	-	24000	D-47880	10,99 €
	12,7	12,7	44,7	-	-	90dg	8	-	28000	D-47896	8,89 €
	15,9	12,7	44	-	-	90dg	8	-	24000	D-47905	9,49 €
	12,7	12,7	54	-	-	90dg	12	-	28000	D-47911	10,99 €
	19	16	47,6	-	-	90dg	8	-	24000	D-47933	10,89 €
	19	16	57,3	-	-	90dg	12	-	24000	D-47949	15,89 €
	12,7	16	48	-	-	60dg	8	-	28000	D-47961	9,39 €
	6,35	6,35	38,3	3,2	-	-	8	-	28000	D-47977	8,09 €
	7,9	8	40	4	-	-	8	-	28000	D-47983	7,89 €
	9,5	9,5	41,3	4,8	-	-	8	-	28000	D-47999	8,09 €
	12,7	10	41,5	6,35	-	-	8	-	28000	D-48000	8,49 €
	15,8	12,7	44,5	7,9	-	-	8	-	24000	D-48016	10,89 €
	15,8	12,7	54	7,9	-	-	12	-	24000	D-48022	11,29 €
	19	12,7	50,8	9,5	-	-	12	-	24000	D-48038	12,69 €
	25,4	16	57	12,7	-	-	12	-	18000	D-48044	19,49 €
	6,35	8	63,5	-	-	7.5 dg	8	-	28000	D-48050	7,99 €
	12,7	13	45	-	-	14 dg	8	-	28000	D-48072	8,49 €
	15	14,3	52	-	-	15 dg	8	-	24000	D-48088	9,79 €
	19	22,2	63,4	-	-	7 dg	12	-	24000	D-48094	12,49 €
	25,4	22,2	64	-	-	14 dg	12	-	18000	D-48103	15,09 €

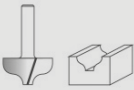
Akumulátory
 Odkladacie systémy
 Vrtanie
 Skrutkovanie
 Brúsky
 Pílenie
 Frézovanie
 Brúsenie
 Klnice / spony
 Špeciálne stroje
 Vysávanie
 Fény/lampy
 Záhrada
 Ručné náradie
 Ostatné

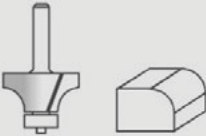
FRÉZOVANIE

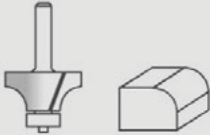
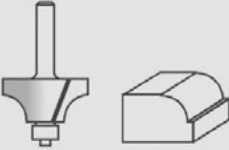

	priemer (mm)	dĺžka (mm)	celková dĺžka (mm)	rádius (mm)	hĺbka rezu (mm)	uhol (dg)	stopka (mm)	veľkosť ložiska (mm)	max. otáčky (rpm)	Obj. č.	MOC s DPH
	19	18,2	50,8	9,5	-	-	8	-	24000	D-48147	12,89 €
	19	12,7	44,7	6,35	-	-	8	-	24000	D-48153	11,69 €
	25,4	16	47,6	9,5	-	-	8	-	18000	D-48169	14,29 €
	38,1	28,6	60,3	12,7	-	-	8	-	16000	D-48175	22,89 €
	19	11	42,4	3,2	-	-	8	-	24000	D-48181	13,19 €
	31,3	16	47,9	6,35	-	-	8	-	18000	D-48197	19,09 €
	12,7	10	42	2,4	-	-	8	-	28000	D-48206	9,29 €
	19	12,7	44,7	4	-	-	8	-	24000	D-48212	13,19 €
	25,4	16	54	5,6	-	-	12	-	18000	D-48228	17,09 €
	19	9,5	42,5	3,2	-	-	6	-	24000	D-48278	9,39 €
	25,4	13,5	45,5	6,35	-	-	6	-	18000	D-48284	13,69 €
	19	9,5	53,4	3,2	-	-	6	12,7	24000	D-48290	11,79 €
	20,6	10	58,6	4	-	-	6	12,7	24000	D-48309	14,19 €
	25,4	13,5	56,5	6,35	-	-	6	12,7	18000	D-48315	16,19 €
	28,6	14,5	57,3	7,9	-	-	6	12,7	18000	D-48321	16,99 €
	31,8	16,7	59,7	9,5	-	-	6	12,7	18000	D-48337	20,59 €

FRÉZOVANIE



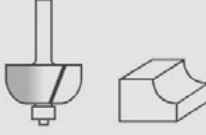
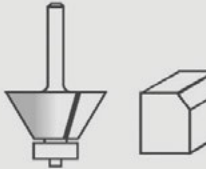
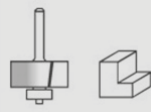
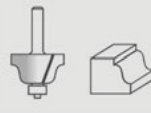

	priemer (mm)	dĺžka (mm)	celková dĺžka (mm)	rádius (mm)	hlĺbka rezu (mm)	uhol (dg)	stopka (mm)	veľkosť ložiska (mm)	max. otáčky (rpm)	Obj. č.	MOC s DPH
TCT profilová vodiaca fréza s ložiskom											
	17,3	8	51	2,3	-	-	8	12,7	24000	D-48343	11,89 €
	19	9,5	53,4	3,2	-	-	8	12,7	24000	D-48359	11,79 €
	20,7	10	52,3	4	-	-	8	12,7	24000	D-48365	14,09 €
	22,2	12,7	55	4,8	-	-	8	12,7	24000	D-48371	13,49 €
	25,4	13,5	56,5	6,35	-	-	8	12,7	18000	D-48387	16,59 €
	28,6	14,5	57,3	7,9	-	-	8	12,7	18000	D-48393	17,39 €
	31,8	16,7	59,7	9,5	-	-	8	12,7	18000	D-48402	20,59 €
	38,1	19	62	12,7	-	-	8	12,7	16000	D-48418	19,29 €
	50,8	25,4	76,2	19	-	-	12	12,7	14000	D-48424	34,39 €
	17	8	49,1	2,3	-	-	6	9,5	24000	D-48430	11,69 €
	19	9,5	51,6	3,2	-	-	6	9,5	24000	D-48446	12,29 €
	20,3	10	50,5	4	-	-	6	9,5	24000	D-48452	13,79 €
	22,2	12,7	53,2	4,8	-	-	6	9,5	24000	D-48468	14,29 €
	28,6	14,5	55,5	7,9	-	-	6	9,5	18000	D-48474	16,89 €
	17,3	8	49,1	2,3	-	-	8	9,5	24000	D-48480	10,99 €
	19	9,5	51,6	3,2	-	-	8	9,5	24000	D-48496	9,89 €
	20,7	10	50,5	4	-	-	8	9,5	24000	D-48505	11,69 €
	22,2	13	53,2	4,8	-	-	8	9,5	24000	D-48511	12,89 €
	25,4	13,5	54,7	6,35	-	-	8	9,5	18000	D-48527	13,69 €
	31,8	17	57,9	9,5	-	-	8	9,5	18000	D-48549	18,79 €
	38,1	19	60,2	12,7	-	-	8	9,5	16000	D-48555	22,59 €
	50,8	25,4	74,5	19	-	-	12	9,5	14000	D-48561	40,89 €
	28,6	12,7	50,8	4	-	-	8	12,7	18000	D-48577	16,09 €

Akumulátory
 Odkladacie systémy
 Vrtanie
 Skrutkovanie
 Brúsky
 Pílenie
 Frézovanie
 Brúsenie
 Klince / spony
 Špeciálne stroje
 Vysávanie
 Fény/lampy
 Záhrada
 Ručné náradie
 Ostatné

FRÉZOVANIE

	priemer (mm)	dĺžka (mm)	celková dĺžka (mm)	rádius (mm)	hĺbka rezu (mm)	uhol (dg)	stopka (mm)	veľkosť ložiska (mm)	max. otáčky (rpm)	Obj. č.	MOC s DPH
TCT profilová vodiaca fréza s ložiskom											
	15,9	6,35	49,2	1,6	-	-	8	12,7	24000	D-48583	14,29 €
	17,5	6,35	49	2,4	-	-	8	12,7	24000	D-48599	14,29 €
	19	9,7	45,6	3,2	-	-	8	12,7	24000	D-48608	10,99 €
	22,2	12,7	55,6	4,8	-	-	8	12,7	24000	D-48614	12,89 €
	28,6	12,7	55,5	7,9	-	-	8	12,7	18000	D-48620	15,29 €
	31,8	14	56	9,5	-	-	8	12,7	18000	D-48636	16,89 €
	38,1	15,4	58,3	12,7	-	-	8	12,7	16000	D-48642	25,19 €
	25,4	11	51	-	-	45dg	6	12,7	18000	D-48658	15,89 €
	22,2	12,7	56,1	-	-	25dg	6	12,7	24000	D-48664	12,99 €
	31,8	13,5	55,1	-	-	45dg	8	12,7	18000	D-48686	21,09 €
	34,9	16	58,8	-	-	45dg	8	12,7	16000	D-48692	22,59 €
	41,3	20	58,9	-	-	45dg	8	12,7	16000	D-48701	31,79 €
	44,5	22,6	68,6	-	-	45dg	12	12,7	16000	D-48717	25,79 €
	50,8	27	70,9	-	-	45dg	12	12,7	14000	D-48723	36,79 €
	31,8	12,2	54,6	-	9,5	-	8	12,7	18000	D-48739	19,59 €
	31,8	12,2	60,8	-	9,5	-	12	12,7	18000	D-48745	15,99 €
	25,4	9,5	52,5	3,2	-	-	6	12,7	18000	D-48804	17,69 €
	28,6	13	55,3	4	-	-	6	12,7	18000	D-48810	14,69 €
	28,6	13	55,3	4	-	-	8	12,7	18000	D-48751	15,19 €
	38,1	17,5	60	6,35	-	-	8	12,7	16000	D-48767	22,59 €
	31,8	12,7	55,6	4,8	-	-	8	12,7	18000	D-48773	18,89 €
	38,1	16	58,9	6,35	-	-	8	12,7	16000	D-48789	26,49 €
	25,4	12,7	53,7	4,8	-	-	6	12,7	18000	D-48795	16,29 €

FRÉZOVANIE

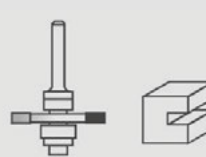
	priemer (mm)	dĺžka (mm)	celková dĺžka (mm)	rádius (mm)	hĺbka rezu (mm)	uhol (dg)	stopka (mm)	veľkosť ložiska (mm)	max. otáčky (rpm)	Obj. č.	MOC s DPH
TCT profilová vodiaca fréza s ložiskom											
	19	26	67,1	-	4,7	-	8	9,5	24000	D-48832	27,59 €
	28,6	41	90,2	-	7,9	-	12	12,7	18000	D-48848	38,09 €
	41	23,4	78,5	-	-	-	12	22	16000	D-48898	52,59 €
	41	23,4	78,5	-	-	-	12	22	16000	D-48898	52,59 €
	30,1	25,4	57,2	-	6,35	-	8	-	18000	D-48913	30,49 €
	41,3	25,4	76,2	-	7,9	-	12	-	16000	D-48929	36,79 €
	41	19	71	-	8,5	-	12	24	16000	D-48935	36,89 €
	47,6	2	59	-	12,7	-	8	22,2	16000	D-48941	18,69 €
	47,6	2,5	59	-	12,7	-	8	22,2	16000	D-48957	18,89 €
	47,6	3	59	-	12,7	-	8	22,2	16000	D-48963	22,09 €
	47,6	4	59	-	12,7	-	8	22,2	16000	D-48979	19,69 €
	47,6	5	59	-	12,7	-	8	22,2	16000	D-48985	18,69 €
	47,6	5,5	59	-	12,7	-	8	22,2	16000	D-48991	19,59 €



Akumulátory
 Odkladacie systémy
 Vrtanie
 Skrutkovanie
 Brúsky
 Pilenie
 Frézovanie
 Brúsenie
 Klince / spony
 Špeciálne stroje
 Vysávanie
 Fény/lampy
 Záhrada
 Ručné náradie
 Ostatné

FRÉZOVANIE

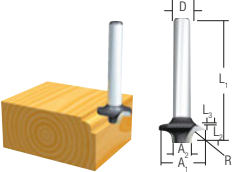
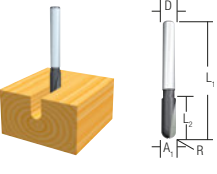
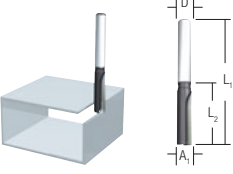
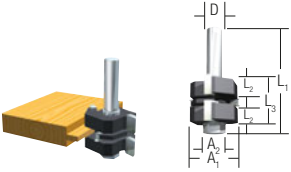
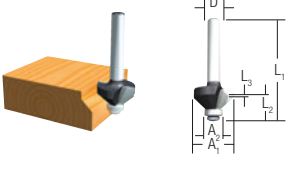
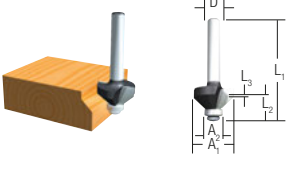
popis	D	A1	A2	A3	A4	L1	L2	L3	L4	R	R1	R2	H	3612, 3612C RP1800FX RP2300FCX	3620, RP0900 RP0910, RP1110C	3707, 3708, 3709, 3710	Obj. č.	MOC s DPH
 <p>fréza na zaoblené hrany</p>	6	20	8		45	10	4		4					•	•	•	D-09357	19,89 €
 <p>drážkovacia fréza</p>	6	6			50	18								•	•	•	191Y83-2	14,39 €
 <p>frézy na hliník</p>	6	10			50	20								•	•	•	D-16988	11,39 €
 <p>pérová fréza</p>	12	38			61	4	20							•			D-12027	51,19 €
 <p>fréza na oblú hrany</p>	6	15	8		37	7	3,5		3					•	•	•	D-09422	22,39 €
 <p>fréza na oblú hrany</p>	6	26	12	8	42	12	4,5		8					•	•	•	D-09547	27,89 €

model	klúč	upínanie	Obj. č.	MOC s DPH
-------	------	----------	---------	-----------

Klieštiny



3706, 3708	17 mm	1/8"	324149-5	11,79 €
		6 mm	763607-0	2,79 €
		1/4"	763608-8	2,59 €
DCO180, DCO181	17 mm	6 mm	763678-7	cena na vyžiadanie
		1/8"	763677-9	cena na vyžiadanie
		1/4"	763676-1	17,29 €
3709, 3710, 3711, 3712, M3700, M3702, MT372	10 mm 17 mm	6 mm	763662-2	4,19 €
		1/4"	763663-0	3,59 €
		matica	763661-4	0,99 €
DRT50, RT0700C, RT0702C, M3601, MT361, RT001G	13 mm 22 mm	6 mm	763636-3	7,99 €
		8 mm	763618-5	1,59 €
		1/4"	763637-1	8,19 €
3612, 3612C, 3612BR	13 mm 24 mm	matica	763615-1	1,29 €
		12 mm	763628-2	17,29 €
		1/2"	763622-4	12,79 €
RP0900	13 mm 22 mm	matica	763629-0	4,19 €
		6 mm	763636-3	7,99 €
		8 mm	763618-5	1,59 €
RP0910, RP1110C	17 mm	1/4"	763637-1	8,19 €
		matica	763615-1	1,29 €
		6 mm	*193180-0	24,49 €
RP1800, RP2300, RP1803, RP2303, 3612, 3612C, M3600, M3602, MT362	24 mm	8 mm	*193178-7	24,29 €
		matica	763652-5	cena na vyžiadanie
		12 mm	763628-2	17,29 €
RP1800, RP1803, RP2300, RP2303, 3612, 3612C	12 mm	1/2"	763622-4	12,79 €
		matica	763674-5	6,09 €
		6 mm	763801-4	4,19 €
		8 mm	763804-8	4,29 €
		10 mm	763807-2	4,49 €
		1/4"	763808-0	5,19 €

* sada

model	A (mm)	B (mm)	C (mm)	Obj. č.	MOC s DPH
-------	--------	--------	--------	---------	-----------

Vodiace objímky



DRT50, 3707/F/FC, 3708/F/FC, 3709, 3710, 3711, 3712, N3701, RT0700C, RT0702C	8	10	9,5	343577-5	0,59 €
DRT50**, 3612BR, RP0900, RP1800/F, RP1801/F, RP1803C, RP2300FC, RP2301FC, RP2303C, RT0700C**, RT0702C**	7,7	09.V	11.V	164379-4	14,79 €
	9	11	13	164775-6	13,89 €
	10	12	9	164388-3	19,79 €
	11	12.VII	13	164776-4	17,39 €
	14.V	16	13	344364-5	2,19 €
	18	20	13	164393-0	26,49 €
	24	27	13	164470-8	21,69 €
	25	29	15	163080-8	10,89 €
RP0910, RP1110C	27	30	13	164471-6	12,39 €
	37	40	13	165046-4	24,59 €
	14,5	16	11,5	193334-9	13,59 €
	27	30	13	193338-1	15,79 €
	37	40	13	193339-9	15,29 €

**Použite s montážou ponorej základne

PRÍSLUŠENSTVO FRÉZY

	popis	Obj. č.	MOC s DPH
Príslušenstvo pre frézy RT0700, DRT50, RT0702C, RT001G			
	vodiaca základňa	196613-4	27,89 €
	platňa základne	454842-8	2,68 €
	vodiaca základňa priehľadná	199089-4	29,19 €
	základňa na ponor	195563-0	93,89 €
	základňa uhlová -30° až 45°	198987-9	37,29 €
	predsadená základňa	195562-2	110,69 €
	taška pre RT0700, RT0702C, DRT50, 3706, RT001G rozmery (Š×V×D) 304 × 406 × 304 mm	831327-5	56,69 €



model	popis	typ	Obj. č.	MOC s DPH
-------	-------	-----	---------	-----------

Príslušenstvo pre frézy



3709, 3710, 3711, 3712	vodiaca základňa		194267-1	cena na vyžiadanie
3709, 3710, 3711, 3712	sklopná základňa		194269-7	65,95 €
3709, 3710, 3708, 3711, 3712, RT001G, RT0700, RT0702C	vedenie frézy		122703-7	4,39 €
3612BR, RP1800, RP2300, RP1803C, RP2303C	vedenie frézy		123022-4	15,69 €

Paralelne dorazy



DRT50, RT0700		A	122965-7	5,19 €
3709, 3710		A	122704-5	4,39 €
3612BR, RP1800, RP2300		A	342428-9	5,69 €
3620, RP0900/0910, RP1110C, M3601, MT361		A	164834-6	5,79 €
DRT50*, RP0900, RP0910, RP1110C, RP1800, RP1803C, RP2300, RP2303C, RT0700C*, RT0702C, RT001G, 3711, 3712		B	195136-9	64,99 €
RT001G**, DRT50**, RT0702C**, 3612BR, RP0900, RP0910, RP1110C, RP1111C, RP1800C, RP1803C, RP2300C, RP2303C	adaptér k vodiacej lište		194579-2	40,59 €

* s použitím ponornej základne 195563-0; ** s použitím základne 195563-0

Držiak paralelného dorazu



3612			122256-6	24,79 €
DRT50, RT001G, RT0700, RT0702C	použitie s ponornou základňou 195563-0		195564-8	7,29 €

Odsávacie adaptéry



RT0700, RT0702C, DRT50, RT001G		A	195559-1	2,99 €
RP0900, RT0700***, RT001G, RT0702C, DRT50***		B	194733-8	3,89 €
3612, M3600, MT362		C	415412-8	4,79 €
RP1800, RP2300, RP1803C, RP2303C		C	194934-8	10,59 €
3706, DCO180, DCO181		D	193449-2	6,19 €

*** použitie s ponornou základňou 195563-0

Akumulátory
Odkladacie systémy
Vrtanie
Skrutkovanie
Brúsky
Pílenie
Frézovanie
Brúsenie
Klince / spony
Špeciálne stroje
Vysávanie
Fény/lampy
Záhraďa
Ručné náradie
Ostatné

FRÉZOVANIE

Príslušenstvo pre štrbinové frézy DPJ180, PJ7000, 3901



ø mm	vrtanie	popis	počet zubov	hrúbka kotúča (mm)	Obj. č.	MOC s DPH
100	22	štrbinová fréza	6	4	B-20644	23,59 €
40		príruba vnútorná			224280-6	3,34 €
40		matica príruby			224505-8	2,64 €
		doraz PJ700, DPJ180			123149-0	20,79 €
		kľúč kolíkový			782401-1	1,29 €
		vak na prach 3901			122474-6	4,59 €
		vak na prach PJ700, DPJ180			123150-5	6,49 €
		adaptér 25 – 27 mm			192349-3	6,99 €
		adaptér odsávania (koleno)			415252-4	1,45 €
		lodička spojovacia N°20 56 × 23,5 mm			P-08850	36,79 €





PRÍSLUŠENSTVO NA BRÚSENIE

Brúsne papiere

V našej ponuke nájdete dva typy brúsnych papierov:

Červené – brúsne papiere s dlhou životnosťou vhodné na brúsenie dreva, farebných kovov, plastov, kovu alebo kameňa. Tieto papiere sú štandardne dodávané perforované alebo neperforované v širokej škále zrnitosti, veľkosti a balení.

Biele – brúsne papiere s dlhou životnosťou vhodné na brúsenie dreva, farebných kovov, plastov, kovu alebo kameňa. Tieto brúsne papiere sú ideálne na konečnú úpravu materiálov – brúsenie farieb a lakov. Brúsne papiere sú štandardne dodávané perforované alebo neperforované v širokej škále zrnitosti, veľkosti a balení.

Použitie brúsnych papierov

farba	drevo	drevené materiály	kov	kameň	plasty	konečná povrchová úprava (farba/lak)
červená	••	••	••	••	••	•
biela	•	•	•	•	•	••

•• Ideálne použitie / • Možné použitie

Každý obal brúsnych papierov Makita obsahuje nasledujúce informácie

Rozloženie dier na odsávanie prachu

Uchytenie (v tomto prípade na suchý zips)

Typ stroja (v tomto prípade excentrická brúska)

Odporúčany materiál (v tomto prípade drevo, kov a dokončovacie práce)

Zrnitosť

Počet kusov v balení

Objednávacie číslo

Rozmer brúsneho papiera

Značky, pri ktorých je možné tiež použiť papier

Vibračné brúsky

Excentrické brúsky

Pásové brúsky

Vibračné brúsky

Multi Tool

Elektrické pilníky

Kov

Farby, lak

Odstraňovanie hrdzí

Suchý zips

Dokončovacie práce

VIBRAČNÉ BRÚSKY – MALÉ VIBRAČNÉ BRÚSKY

popis	zrornosť	ks/bal	BO4555	BO4556	BO4557	BO4565	BO4563	Obj. č.	MOC s DPH
-------	----------	--------	--------	--------	--------	--------	--------	---------	-----------

Brúsny papier 114 × 140mm, neperforovaný



Vhodné pre farebné kovy, plasty, drevo, drevo s klincami, kov, kameň



brúsny papier	40	10	•	•	•			P-36398	3,19 €
	60	10	•	•	•			P-32904	2,79 €
	80	10	•	•	•			P-36407	2,69 €
	100	10	•	•	•			P-32910	2,49 €
	120	10	•	•	•			P-32926	2,49 €
	150	10	•	•	•			P-32932	2,49 €
	180	10	•	•	•			P-36413	2,49 €
	240	10	•	•	•			P-36429	2,49 €

Brúsny papier 114 × 140mm, neperforovaný



Vhodné pre laky a farby, farebné kovy, plasty, drevo, drevo s klincami, kov, kameň.

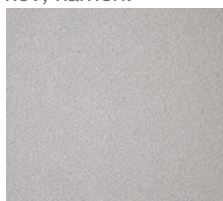

brúsny papier	60	10	•	•	•			P-36522	3,59 €
	100	10	•	•	•			P-36544	3,39 €
	120	10	•	•	•			P-36550	3,39 €

Brúsny papier na suchý zips 114 × 102mm, perforovaný, 6 otvorov



Vhodné pre farebné kovy, plasty, drevo, drevo s klincami, kov, kameň.



brúsny papier	40	10	•		•	•		P-33087	3,99 €
	60	10	•		•	•		P-33093	3,89 €
	80	10	•		•	•		P-33102	3,79 €
	100	10	•		•	•		P-33118	3,69 €
	120	10	•		•	•		P-33124	3,69 €
	150	10	•		•	•		P-33130	3,69 €
	180	10	•		•	•		P-33146	3,69 €
	240	10	•		•	•		P-33152	3,69 €
	320	10	•		•	•		P-33168	3,69 €
	40	50	•		•	•		P-42416	16,89 €
	60	50	•		•	•		P-42422	16,39 €
	80	50	•		•	•		P-42438	15,69 €
	120	50	•		•	•		P-42450	15,49 €

VIBRAČNÉ BRÚSKY – MALÉ VIBRAČNÉ BRÚSKY

popis	zrornosť	ks/bal	BO4555	BO4556	BO4557	BO4565	BO4563	Obj. č.	MOC s DPH
-------	----------	--------	--------	--------	--------	--------	--------	---------	-----------

Brúsny papier na suchý zips 114 x 102mm, perforovaný 6 otvorov



Vhodné pre laky a farby, farebné kovy, plasty, drevo, drevo s klincami, kov, kameň.



brúsny papier	zrornosť	ks/bal	BO4555	BO4556	BO4557	BO4565	BO4563	Obj. č.	MOC s DPH
	40	10	•		•	•		P-35807	4,69 €
	60	10	•		•	•		P-35813	4,39 €
	80	10	•		•	•		P-35829	4,29 €
	100	10	•		•	•		P-35835	4,19 €
	120	10	•		•	•		P-35841	4,19 €
	150	10	•		•	•		P-35857	4,19 €
	320	10	•		•	•		P-35885	4,19 €
	40	50	•		•	•		P-42503	20,09 €
	60	50	•		•	•		P-42519	18,79 €
	150	50	•		•	•		P-42553	17,79 €

Brúsny papier na suchý zips 95 x 95 x 95mm, perforovaný 6 otvorov



Vhodné pre farebné kovy, plasty, drevo, drevo s klincami, kov, kameň.



brúsny papier	zrornosť	ks/bal	BO4555	BO4556	BO4557	BO4565	BO4563	Obj. č.	MOC s DPH
	40	10				•	•	P-33255	3,19 €
	60	10				•	•	P-33261	3,19 €
	80	10				•	•	P-33277	3,09 €
	100	10				•	•	P-33283	2,99 €
	120	10				•	•	P-33299	2,99 €
	150	10				•	•	P-33308	2,99 €
	180	10				•	•	P-33314	2,99 €
	240	10				•	•	P-33320	2,99 €
	320	10				•	•	P-33336	2,99 €
	40	50				•	•	P-42597	12,89 €
	60	50				•	•	P-42606	12,49 €
	80	50				•	•	P-42612	12,19 €
	100	50				•	•	P-42628	11,89 €
	120	50				•	•	P-42634	11,89 €
	150	50				•	•	P-42640	11,89 €
	180	50				•	•	P-42656	11,89 €
	240	50				•	•	P-42662	11,89 €

Brúsny papier na suchý zips 95 x 95 x 95mm, perforovaný 6 otvorov



Vhodné pre laky a farby, farebné kovy, plasty, drevo, drevo s klincami, kov, kameň.



brúsny papier	zrornosť	ks/bal	BO4555	BO4556	BO4557	BO4565	BO4563	Obj. č.	MOC s DPH
	40	10				•	•	P-42684	3,19 €
	60	10				•	•	P-42690	3,09 €
	80	10				•	•	P-42709	3,09 €
	100	10				•	•	P-42715	2,99 €
	120	10				•	•	P-42721	2,99 €
	150	10				•	•	P-42737	2,99 €
	240	10				•	•	P-42759	2,99 €
	320	10				•	•	P-42765	2,89 €
	60	50				•	•	P-42787	12,19 €
	80	50				•	•	P-42793	11,99 €
	100	50				•	•	P-42802	11,69 €
	120	50				•	•	P-42818	11,69 €

Akumulátory
Odkladacie systémy
Vrtanie
Skrutkovanie
Brúsky
Pílenie
Frézovanie
Brúsenie
Špeciálne stroje
Klince / spony
Vysávanie
Fény/lampy
Záhraďa
Ručné náradie
Ostatné

VIBRAČNÉ BRÚSKY – MALÉ VIBRAČNÉ BRÚSKY

popis	zrornosť	ks/bal	BO4555	BO4556	BO4557	BO4565	BO4563	Obj. č.	MOC s DPH
-------	----------	--------	--------	--------	--------	--------	--------	---------	-----------

Brúsny papier na suchý zips 100 × 240mm, perforovaný, 10 otvorov



Vhodné pre farebné kovy, plasty, drevo, drevo s klincami, kov, kameň.

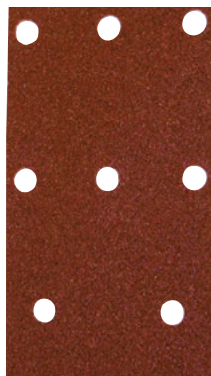

brúsny papier	40	10	•		•	•	P-42868	5,69 €
	60	10	•		•	•	P-42874	5,49 €
	100	10	•		•	•	P-42896	5,29 €
	120	10	•		•	•	P-42905	5,29 €

Brúsny papier 93 × 228mm, perforovaný



Vhodné pre farebné kovy, plasty, drevo, drevo s klincami, kov, kameň.



brúsny papier	40	10		•		P-31837	3,09 €
	60	10		•		P-31843	2,89 €
	80	10		•		P-31859	2,79 €
	100	10		•		P-31865	2,79 €
	120	10		•		P-36011	2,79 €
	150	10		•		P-36027	2,79 €
	180	10		•		P-36033	2,79 €
	240	10		•		P-36049	2,79 €
	40	50		•		P-36055	12,09 €
	60	50		•		P-36061	10,99 €
	80	50		•		P-36077	10,69 €
	100	50		•		P-36083	10,39 €
	120	50		•		P-36099	10,39 €
	150	50		•		P-36108	10,39 €
	180	50		•		P-36114	10,39 €
	240	50		•		P-36120	10,39 €

Brúsny papier na suchý zips 93 × 185mm, perforovaný, suchý zips



Vhodné pre farebné kovy, plasty, drevo, drevo s klincami, kov, kameň.

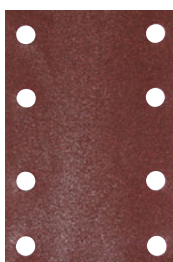

brúsny papier	40	10		•		P-31871	4,79 €
	60	10		•		P-31887	4,29 €
	80	10		•		P-31893	4,19 €
	100	10		•		P-31902	4,09 €
	120	10		•		P-35891	4,09 €
	150	10		•		P-35900	4,09 €
	180	10		•		P-35916	4,09 €
	240	10		•		P-35922	4,09 €
	40	50		•		P-35938	20,59 €
	60	50		•		P-35944	18,09 €
	80	50		•		P-35950	17,59 €
	100	50		•		P-35966	16,99 €
	120	50		•		P-35972	16,99 €
	150	50		•		P-35988	16,99 €
	180	50		•		P-35994	16,99 €

VIBRAČNÉ BRÚSKY – MALÉ VIBRAČNÉ BRÚSKY

popis	zrornosť	ks/bal	9036	BO3700, BO3710, BO3711	BO4900V	9046	Obj. č.	MOC s DPH
-------	----------	--------	------	------------------------------	---------	------	---------	-----------

Brúsny papier 93 × 228 mm, neperforovaný



Vhodné pre farebné kovy, plasty, drevo, drevo s klincami, kov, kameň.



brúsny papier	40	10	•	•			P-36136	2,69 €
	60	10	•	•			P-32948	2,49 €
	80	10	•	•			P-36142	2,39 €
	100	10	•	•			P-32954	2,29 €
	120	10	•	•			P-36158	2,29 €
	240	10	•	•			P-36170	2,29 €

Brúsny papier 115 × 280 mm, perforovaný, 14 otvorov



Vhodné pre farebné kovy, plasty, drevo, drevo s klincami, kov, kameň.

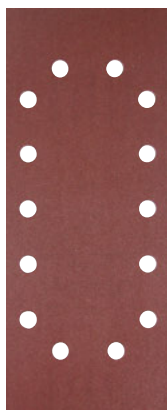

brúsny papier	40	10			•	•	P-33009	3,89 €
	60	10			•	•	P-33015	3,59 €
	80	10			•	•	P-33021	3,49 €
	100	10			•	•	P-33037	3,39 €
	120	10			•	•	P-33043	3,39 €
	150	10			•	•	P-33059	3,39 €
	180	10			•	•	P-33065	3,39 €
	150	50			•	•	P-35695	13,89 €



Akumulátory
 Odkladacie systémy
 Vrtanie
 Skrutkovanie
 Brúsky
 Pílenie
 Frézovanie
 Brúsenie
 Klince / spony
 Špeciálne stroje
 Vysávanie
 Fény/lampy
 Záhrada
 Ručné náradie
 Ostatné

VIBRAČNÉ BRÚSKY – MALÉ VIBRAČNÉ BRÚSKY

popis	zrnitosť	ks/bal	9036	BO3700, BO3710, BO3711	BO4900V	9046	Obj. č.	MOC s DPH
-------	----------	--------	------	------------------------------	---------	------	---------	-----------

Brúsny papier so suchým zipsom 115 x 229mm, perforovaný 10 otvorov



Vhodné pre farebné kovy, plasty, drevo, drevo s klincami, kov, kameň.

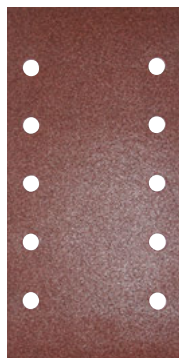

brúsny papier	40	10			•	•	P-33174	6,19 €
	60	10			•	•	P-33180	5,89 €
	80	10			•	•	P-33196	5,59 €
	100	10			•	•	P-33205	5,49 €
	120	10			•	•	P-33211	5,49 €
	180	10			•	•	P-33233	5,49 €
	240	10			•	•	P-33249	5,49 €
	80	50			•	•	P-35748	24,69 €

Brúsny papier so suchým zipsom 115 x 229mm, perforovaný 14 otvorov



Vhodné pre farebné kovy, plasty, drevo, drevo s klincami, kov, kameň.

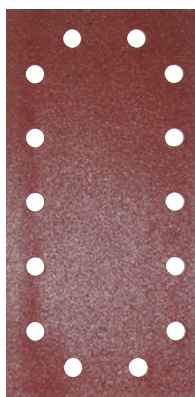

brúsny papier	40	10			•	•	P-43022	6,19 €
	60	10			•	•	P-43038	5,89 €
	80	10			•	•	P-43044	5,59 €
	100	10			•	•	P-43050	5,49 €
	120	10			•	•	P-43066	5,49 €
	80	50			•	•	P-43125	24,69 €
	240	50			•	•	P-43175	24,09 €

EXCENTRICKÉ BRÚSKY

Brúsny papier na suchý zips 125 mm, 8 otvorov



Vhodné pre farebné kovy, plasty, drevo, drevo s klincami, kov, kameň.

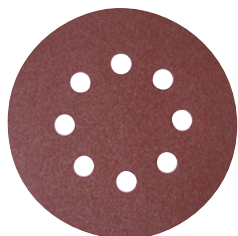

popis	zrnitosť	ks/bal	BO5010, BO5012, BO5030, BO5031	BO5020, BO5021, BO5041	BO6030	BO6040	Obj. č.	MOC s DPH
brúsny papier	40	10	•	•			P-43533	4,59 €
	60	10	•	•			P-43549	4,39 €
	80	10	•	•			P-43555	4,09 €
	100	10	•	•			P-43561	4,09 €
	120	10	•	•			P-43577	4,09 €
	180	10	•	•			P-43583	4,09 €
	240	10	•	•			P-43599	4,09 €
	320	10	•	•			P-43608	4,09 €
	400	10	•	•			P-43614	4,09 €
	40	50	•	•			P-43620	20,09 €
	60	50	•	•			P-43636	19,19 €
	80	50	•	•			P-43642	17,89 €
	100	50	•	•			P-43658	17,49 €
	120	50	•	•			P-43664	17,49 €
	180	50	•	•			P-43670	17,49 €
	240	50	•	•			P-43686	17,49 €
	320	50	•	•			P-43692	17,49 €
	400	50	•	•			P-43701	17,49 €

Brúsny papier na suchý zips 125 mm, 8 otvorov



Vhodné pre farebné kovy, plasty, drevo, drevo s klincami, kov, kameň.

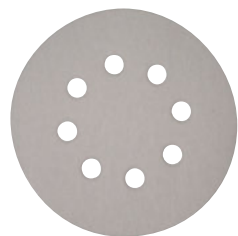

popis	zrnitosť	ks/bal	BO5010, BO5012, BO5030, BO5031	BO5020, BO5021, BO5041	BO6030	BO6040	Obj. č.	MOC s DPH
brúsny papier	40	10	•	•			P-33342	4,09 €
	60	10	•	•			P-33358	3,99 €
	80	10	•	•			P-33364	3,69 €
	100	10	•	•			P-33370	3,59 €
	120	10	•	•			P-33386	3,59 €
	180	10	•	•			P-33392	3,59 €
	240	10	•	•			P-33401	3,59 €
	320	10	•	•			P-33417	3,59 €
	400	10	•	•			P-33423	3,59 €
	40	50	•	•			P-37384	17,69 €
	60	50	•	•			P-37390	16,89 €
	80	50	•	•			P-37409	15,69 €
	100	50	•	•			P-37415	15,69 €
	120	50	•	•			P-37421	15,19 €
	180	50	•	•			P-37437	15,19 €
	240	50	•	•			P-37443	15,19 €
	320	50	•	•			P-37459	15,19 €
	400	50	•	•			P-37465	15,19 €

Akumulátory
 Odkladacie systémy
 Vrtanie
 Skrutkovanie
 Brúsky
 Pílenie
 Frézovanie
 Brúsenie
 Klince / spony
 Špeciálne stroje
 Vysávanie
 Fény/lampy
 Záhrada
 Ručné náradie
 Ostatné

EXCENTRICKÉ BRÚSKY

popis	zrornosť	ks/bal	BO5010, BO5012, BO5030, BO5031	BO5020, BO5021, BO5041	BO6030	BO6040	Obj. č.	MOC s DPH
-------	----------	--------	---	------------------------------	--------	--------	---------	-----------

Brúsny papier na suchý zips 150mm, 6 otvorov



Vhodné pre laky a farby, farebné kovy, plasty, drevo, drevo s klincami, kov, kameň.



brúsny papier	40	10			•	•	P-37471	6,39 €
	60	10			•	•	P-37487	6,29 €
	80	10			•	•	P-37493	6,09 €
	100	10			•	•	P-37502	5,59 €
	120	10			•	•	P-37518	5,59 €
	180	10			•	•	P-37524	5,59 €
	240	10			•	•	P-37530	5,59 €
	320	10			•	•	P-37546	5,59 €
	400	10			•	•	P-37552	5,59 €
	40	50			•	•	P-37568	29,89 €
	60	50			•	•	P-37574	28,89 €

Brúsny papier na suchý zips 150mm, 6 otvorov



Vhodné pre laky a farby, farebné kovy, plasty, drevo, drevo s klincami, kov, kameň.



brúsny papier	80	50			•	•	P-37580	27,89 €
	100	50			•	•	P-37596	25,79 €
	120	50			•	•	P-37605	25,79 €
	180	50			•	•	P-37611	25,79 €
	240	50			•	•	P-37627	25,79 €
	320	50			•	•	P-37633	25,79 €
	400	50			•	•	P-37649	25,79 €

Brúsny papier na suchý zips 150mm, 6 otvorov



Vhodné pre laky a farby, farebné kovy, plasty, drevo, drevo s klincami, kov, kameň.



brúsny papier	40	10			•	•	P-37655	6,09 €
	60	10			•	•	P-37661	5,59 €
	80	10			•	•	P-37677	5,49 €
	100	10			•	•	P-37683	5,29 €
	150	10			•	•	P-37699	5,29 €
	180	10			•	•	P-37708	5,29 €
	240	10			•	•	P-37714	5,29 €
	400	10			•	•	P-37736	5,29 €
	40	50			•	•	P-37742	26,19 €
	60	50			•	•	P-37758	24,19 €
	80	50			•	•	P-37764	23,19 €
	120	50			•	•	P-37786	22,39 €
	180	50			•	•	P-37792	22,39 €
	240	50			•	•	P-37801	22,39 €
	320	50			•	•	P-37817	22,39 €

EXCENTRICKÉ BRÚSKY

popis	zrornosť	ks/bal	BO5010, BO5012, BO5030, BO5031	BO5020, BO5021, BO5041	BO6030	BO6040	Obj. č.	MOC s DPH
-------	----------	--------	---	------------------------------	--------	--------	---------	-----------

Brúsny papier na suchý zips 150 mm, 8 + 1 otvor



Vhodné pre farebné kovy, plasty, drevo, drevo s klincami, kov, kameň.



brúsny papier	40	10			•	•	P-31918	6,39 €
	60	10			•	•	P-31924	6,29 €
	80	10			•	•	P-31930	6,09 €
	100	10			•	•	P-31946	5,59 €
	120	10			•	•	P-31952	5,59 €
	150	10			•	•	P-31968	5,59 €
	180	10			•	•	P-31974	5,59 €
	220	10			•	•	P-31980	5,59 €
	240	10			•	•	P-31996	5,59 €
	320	10			•	•	P-32007	5,59 €
	60	50			•	•	P-32580	28,89 €
	80	50			•	•	P-32596	27,89 €
	400	50			•	•	P-32677	25,79 €

Brúsny papier na suchý zips 150 mm, 8 + 1 otvor



Vhodné pre laky a farby, farebné kovy, plasty, drevo, drevo s klincami, kov, kameň.



brúsny papier	40	10			•	•	P-37839	6,09 €
	60	10			•	•	P-37845	5,59 €
	80	10			•	•	P-37851	5,49 €
	100	10			•	•	P-37867	5,29 €
	120	10			•	•	P-37873	5,29 €
	150	10			•	•	P-37889	5,29 €
	180	10			•	•	P-37895	5,29 €
	220	10			•	•	P-37904	5,29 €
	240	10			•	•	P-37910	5,29 €
	400	10			•	•	P-37932	5,29 €
	100	50			•	•	P-37976	22,39 €
	240	50			•	•	P-38009	22,39 €
	320	50			•	•	P-38015	22,39 €
	400	50			•	•	P-38021	22,39 €

Akumulátory
Odkladacie systémy
Vrtanie
Skrutkovanie
Brúsky
Pílenie
Frézovanie
Brúsenie
Klince / spony
Špeciálne stroje
Vysávanie
Fény/lampy
Záhradná
Ručné náradie
Ostatné

EXCENTRICKÉ BRÚSKY

popis	rozměr / m	zrnitost	Obj. č.	MOC s DPH
-------	------------	----------	---------	-----------

Brúsny papier / rolka



brúsny papier	120 / 5	40	P-38102	6,89 €
	120 / 5	60	P-38118	5,49 €
	120 / 5	80	P-38124	4,79 €
	120 / 50	80	P-38211	43,19 €
	120 / 5	100	P-38130	4,39 €
	120 / 5	120	P-38146	4,39 €
	120 / 5	180	P-38152	4,39 €
	120 / 5	240	P-38168	4,39 €
	120 / 5	320	P-38174	4,39 €
	120 / 5	400	P-38180	4,39 €



ELEKTRICKÉ PILNÍKY

popis	zrnitosť	ks/bal	9032	9031	9910	9911	Obj. č.	MOC s DPH
-------	----------	--------	------	------	------	------	---------	-----------

Textilný brúsny pás 6 × 533 mm



Vhodné pre farebné kovy, plasty, drevo, drevo s klincami, kov, kameň.



Brúsny papier	40	5	•				P-43181	4,89 €
	60	5	•				P-43197	4,79 €
	80	5	•				P-43206	4,69 €
	100	5	•				P-43212	4,69 €
	120	5	•				P-43228	4,69 €

Textilný brúsny pás 9 × 533 mm



Vhodné pre farebné kovy, plasty, drevo, drevo s klincami, kov, kameň.



Brúsny papier	40	5	•				P-43256	5,59 €
	60	5	•				P-43262	5,39 €
	80	5	•				P-43278	5,29 €
	100	5	•				P-43284	5,19 €
	120	5	•				P-43290	5,19 €
	150	5	•				P-43309	5,19 €
	240	5	•				P-43315	5,19 €
	40	5	•				P-43256	5,59 €
	60	5	•				P-43262	5,39 €
	80	5	•				P-43278	5,29 €
	100	5	•				P-43284	5,19 €
	120	5	•				P-43290	5,19 €

Textilný brúsny pás 13 × 533 mm



Vhodné pre farebné kovy, plasty, drevo, drevo s klincami, kov, kameň.



Brúsny papier	40	5	•				P-43321	6,99 €
	60	5	•				P-43337	6,79 €
	80	5	•				P-43343	6,59 €
	100	5	•				P-43359	6,49 €
	120	5	•				P-43365	6,49 €
	150	5	•				P-43371	6,49 €

Textilný brúsny pás 30 × 533 mm



Vhodné pre farebné kovy, plasty, drevo, drevo s klincami, kov, kameň.



Brúsny papier	40	5	•				P-36675	4,39 €
	60	5	•				P-36681	4,29 €
	80	5	•				P-36697	4,19 €
	100	5	•				P-36706	3,99 €
	120	5	•				P-36712	3,99 €
	150	5	•				P-36728	3,99 €
	240	5	•				P-36734	3,99 €

ELEKTRICKÉ PILNÍKY

popis	zrnitosť	ks/bal	9032	9031	9910	9911	Obj. č.	MOC s DPH
-------	----------	--------	------	------	------	------	---------	-----------

Textilný brúsny pás 30 × 533 mm



Vhodné na sklo –
suché brúsenie.



Brúsny papier	60	5		•			P-01404	9,69 €
	80	5		•			P-01199	9,49 €
	100	5		•			P-01208	9,09 €
	120	5		•			P-01214	8,09 €
	150	5		•			P-01220	8,09 €
	240	5		•			P-01236	8,09 €

PÁSOVÉ BRÚSKY

Textilný brúsny pás 76 × 457 mm



Vhodné na sklo –
suché brúsenie



Brúsny papier	40	5			•	•	P-37091	9,09 €
	60	5			•	•	P-37100	8,89 €
	80	5			•	•	P-37116	8,79 €
	100	5			•	•	P-37122	8,69 €
	120	5			•	•	P-37138	8,69 €
	150	5			•	•	P-37144	8,69 €
	240	5			•	•	P-37150	8,69 €
	40, 80, 120	3			•	•	P-37166	5,29 €

popis	zrnitosť	ks/bal	9903	9920	9924DB	9402	9403	9404	Obj. č.	MOC s DPH
-------	----------	--------	------	------	--------	------	------	------	---------	-----------

Textilný brúsny pás 76 × 533 mm



Vhodné pre farebné
kovy, plasty, drevo,
drevo s klincami,
kov, kameň.



Brúsny papier	40	5	•						P-37172	9,89 €
	60	5	•						P-37188	9,39 €
	80	5	•						P-37194	8,79 €
	100	5	•						P-37203	8,59 €
	120	5	•						P-37219	8,59 €
	150	5	•						P-37225	8,59 €
	240	5	•						P-37231	8,59 €
	40	25	•						P-37247	42,49 €
	60	25	•						P-37253	40,59 €
	80	25	•						P-37269	36,69 €
	100	25	•						P-37275	35,99 €
	120	25	•						P-37281	35,99 €
	150	25	•						P-37297	35,99 €
	40	50	•						P-43393	78,69 €
	60	50	•						P-43402	75,79 €
	80	50	•						P-43418	72,49 €
	100	50	•						P-43424	71,99 €
	120	50	•						P-43430	71,99 €
	150	50	•						P-43446	71,99 €

PÁSOVÉ BRÚSKY

popis	zrňitosť	ks/bal	9903	9920	9924DB	9402	9403	9404	Obj. č.	MOC s DPH
-------	----------	--------	------	------	--------	------	------	------	---------	-----------

Textilný brúsny pás 76 × 610 mm



Vhodné pre farebné kovy, plasty, drevo, drevo s klincami, kov, kameň.



Brúsny papier	40	40	5		•	•			P-37312	10,69 €
	60	60	5		•	•			P-37328	10,29 €
	80	80	5		•	•			P-37334	9,49 €
	100	100	5		•	•			P-37340	9,19 €
	120	120	5		•	•			P-37356	9,19 €
	150	150	5		•	•			P-37362	9,19 €
	240	240	5		•	•			P-37378	9,19 €
	40	40	25		•	•			P-51144	47,89 €
	80	80	25		•	•			P-51164	41,89 €
	100	100	25		•	•			P-51172	40,79 €
	120	120	25		•	•			P-51188	36,99 €

Textilný brúsny pás 100 × 610 mm



Vhodné pre farebné kovy, plasty, drevo, drevo s klincami, kov, kameň.



Brúsny papier	40	5			•	•	•	•	P-36887	12,29 €
	60	5			•	•	•	•	P-36893	11,79 €
	80	5			•	•	•	•	P-36902	11,59 €
	100	5			•	•	•	•	P-36918	11,19 €
	120	5			•	•	•	•	P-36924	11,19 €
	150	5			•	•	•	•	P-36930	11,19 €
	240	5			•	•	•	•	P-36946	11,19 €
	40	25			•	•	•	•	P-36952	51,79 €
	60	25			•	•	•	•	P-36968	49,29 €
	80	25			•	•	•	•	P-36974	48,29 €
	100	25			•	•	•	•	P-36980	47,79 €
	120	25			•	•	•	•	P-36996	47,79 €
	150	25			•	•	•	•	P-37007	47,79 €
	240	25			•	•	•	•	P-37013	47,79 €
	40	50			•	•	•	•	P-43468	103,49 €
	60	50			•	•	•	•	P-43474	98,59 €
	80	50			•	•	•	•	P-43480	96,59 €
	100	50			•	•	•	•	P-43496	95,59 €
	120	50			•	•	•	•	P-43505	95,59 €
	150	50			•	•	•	•	P-43511	95,59 €
	240	50			•	•	•	•	P-43527	95,59 €

Akumulátory
 Odkladacie systémy
 Vrtanie
 Skrutkovanie
 Brúsky
 Pílenie
 Frézovanie
 Brúsenie
 Klince / spony
 Špeciálne stroje
 Vysávanie
 Fény/lampy
 Záhrada
 Ručné náradie
 Ostatné

PÁSOVÉ BRÚSKY

popis	zrŕitosť	ks/bal	9903	9920	9924DB	9402	9403	9404	Obj. č.	MOC s DPH
-------	----------	--------	------	------	--------	------	------	------	---------	-----------

Textilný brúsny pás 100 × 620mm



Vhodné pre farebné kovy, plasty, drevo, drevo s klincami, kov, kameň.



Brúsny papier	60	5			•				P-37035	11,99 €
	80	5			•				P-37041	11,79 €
	120	5			•				P-37063	11,49 €
	150	5			•				P-37079	11,49 €
	240	5			•				P-37085	11,49 €

Textilný brúsny pás 100 × 560mm



Vhodné pre farebné kovy, plasty, drevo, drevo s klincami, kov, kameň.



Brúsny papier	40	5	•	•	•	•	•	•	P-36740	11,49 €
	60	5	•	•	•	•	•	•	P-36756	11,09 €
	80	5	•	•	•	•	•	•	P-36762	10,99 €
	100	5	•	•	•	•	•	•	P-36778	10,79 €
	120	5	•	•	•	•	•	•	P-36784	10,79 €
	40	25	•	•	•	•	•	•	P-36815	46,09 €
	60	25	•	•	•	•	•	•	P-36821	44,69 €
	80	25	•	•	•	•	•	•	P-36837	43,89 €

popis	ø (mm)	typ	Obj. č.	MOC s DPH
-------	--------	-----	---------	-----------

Príslušenstvo pre DSL800, DSL801



brúsny tanier	220	HARD	199938-5	62,89 €
suchý zip	210	SOFT	199939-3	60,49 €
	210	MEDIUM	199940-8	68,29 €
náhradné kefky		1	140J85-5	49,36 €
		2	140J86-3	12,61 €
predĺženie sada			199937-7	190,29 €

ø (mm)	zrŕitosť	popis	ks/bal	Obj. č.	MOC s DPH
--------	----------	-------	--------	---------	-----------

Príslušenstvo pre DSL800, DSL801



225	40	brúsny papier	25	B-68389	35,09 €
225	80		25	B-68395	33,29 €
225	120		25	B-68404	28,79 €
225	180		25	B-68410	28,79 €
225	320		25	B-68426	28,79 €

PRÍSLUŠENSTVO BRÚSKY

model	popis	ø (mm)	typ	Obj. č.	MOC s DPH
-------	-------	--------	-----	---------	-----------

Brúsne taniere



BO6050	suchý zip	150	SOFT	197314-7	46,69 €
	suchý zip	130	HARD	197317-1	51,69 €
DPO500, DPO600, PO6000C, PV001G	suchý zip	125		197922-4	63,69 €
DBO180, BO5030/31 BO5040/41	suchý zip	123		197468-0	14,79 €
BO6030 BO6040	suchý zip	150	SOFT	196684-1	27,69 €
	suchý zip	150	MEDIUM	196685-9	23,99 €
	suchý zip	150	HARD	196686-7	27,99 €
9237C/CB PV7000 SA7000	gumený	170		P-05913	7,09 €
	suchý zip	165		743053-3	19,69 €
9237C/CB PV7000 SA7000	suchý zip	120		P-21777	10,19 €

Leštiace kotúče

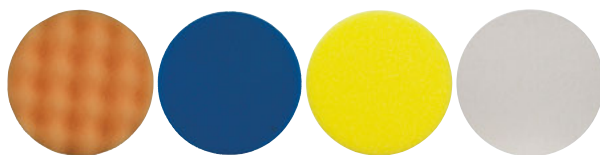

BO6030, BO6050, DPO500, DPO600	plstený kotúč na odstraňovanie vosku	150	suchý zip	193288-0	24,09 €
BO5031, BO5041, DPO0500, DPO0600, DBO180	tanier na nanášanie vosku, žltý	125	suchý zip	794558-6	26,49 €

Kotúče z jahňaciny na leštenie do vysokého lesku



BO5031, BO5041, DBO180		140	suchý zip	794560-9	17,19 €
BO6030, BO6050, DPO0500, DPO0600, PO6000C		150	suchý zip	199424-6	26,39 €
PV001G, 9237CB		180	suchý zip	192629-7	19,29 €
SA7000C		180		*794176-0	25,19 €

*použitie s brúsnym tanierom P-05913

Príslušenstvo pre brúsky DPV300 / PV301



DPV300 PV301	leštenie do vysokého lesku	80	plstený/ suchý zip	191N92-5	12,69 €
	penová špongia na nanášanie vosku	80	biela/ suchý zip	191N91-7	13,09 €
	penová špongia na leštenie	80	žltá/ suchý zip	191N90-9	10,39 €
	adaptér pre pad 743124-6			743126-2	cena na vyžiadanie

Akumulátory
Odkladacie systémy
Vrtanie
Skrutkovanie
Brúsky
Pílenie
Frézovanie
Brúsenie
Klince / spony
Špeciálne stroje
Vysávanie
Fény/lampy
Záhrada
Ručné náradie
Ostatné

PRÍSLUŠENSTVO BRÚSKY

Priemer (mm)	Použitie	Zrnitosť	Ks/bal.	Obj. č.	MOC s DPH
--------------	----------	----------	---------	---------	-----------

Brúsne kotúče pre DPV300 / PW301

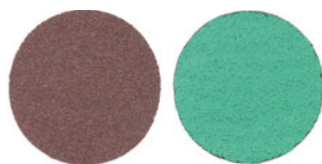

Aluminum oxide

Zirconia alumina

50	kov	A60	25	E-07412	44,99 €
50	kov	A80	25	E-07428	44,99 €
50	kov	A120	25	E-07434	44,99 €
50	kov	Z60	25	E-07440	44,99 €
50	kov	Z80	25	E-07456	44,99 €

Brúsne kotúče s rúnom pre DPV300 / PW301



Hard

Soft

50	Tvrdý: povrchové leštenie, odstraňovanie farby a hrdzi	hrubý	25	E-07462	82,09 €
50		stredný	25	E-07478	82,09 €
50		mäkký	25	E-07484	82,09 €
50	Jemný: povrchové leštenie	stredný	25	E-07490	71,79 €
50		mäkký	25	E-07509	71,69 €
50		veľmi jemný	25	E-07515	71,69 €

model	Popis	ks/bal	Obj. č.	MOC s DPH
-------	-------	--------	---------	-----------

Dierovacie dosky pre brúsky





BO4555, BO4556, BO4557, BO4558, DBO480, DBO481, DBO482	dierovacia doska	1	450066-4	1,19 €
BO3700, BO3710, BO3711, DBO380, DBO381	dierovacia doska	1	192989-7	6,29 €
9046, BO4900V	dierovacia doska	1	192523-3	26,59 €

Základné dosky pre brúsky



DBO180, BO5030, BO5031, BO5040, BO5041, M9204, MT924	doska základná suchý zip	1	197468-0	14,79 €
BO4555	doska základná suchý zip	1	158323-1	6,16 €
BO4556, BO4557, BO4558	doska základná suchý zip	1	158324-9	4,16 €
DBO480	doska základná, trojuholník, suchý zip	1	191Y22-2	8,99 €
DBO480	doska základná, obdĺžnik, suchý zip	1	191Y23-0	8,29 €
DBO480	doska základná, štvorec, suchý zip	1	191Y24-8	6,79 €
BO3070, BO3710, BO3711, DBO380, DBO381,	doska základná suchý zip	1	194930-6	15,39 €
BO4900V	doska základná suchý zip	1	193521-0	48,41 €
9036	doska základná	1	122442-9	51,65 €
DBO380, DBO381, BO3700, BO3710, BO3711, M9203	doska základná	1	140441-9	4,14 €
9046	doska základná	1	162172-0	35,12 €
DBO480	doska základná štvorec	1	191Y25-6	5,59 €

PRÍSLUŠENSTVO BRÚSKY

model	popis	ks/bal	Obj. č.	MOC s DPH	
Papierové sáčky a držiaky *****					
	BO3711, BO4558, BO4565, BO5031, BO5041, DBO180, DBO380, DBO381,	PVC box s papierovým vrecom	1	135246-0	6,19 €
	BO3711, BO4558, BO4565, BO5031, BO5041, DBO180, DBO380, DBO381,	papierové vreco pre PVC box 135246-0	5	194746-9	5,99 €
	BO3711, BO4558, BO4565, BO5031, BO5041, DBO180, DBO380, DBO381,	vak na prach látkový	1	135222-4	cena na vyžiadanie
	9046, BO3700, BO371, BO3711, BO4900, BO6030	držiak na papierové vreco	1	193294-5	11,49 €
	9046, BO3700, BO371, BO3711, BO4900, BO6030	papierové vreco pre držiak 193294-5	5	193293-7	6,79 €
	BO4900, BO4900V, BO6030	vak na prach látkový	1	151517-7	25,39 €
	BO3711, BO4558, BO4565, BO5031, BO5041, DBO180, DBO380, DBO381,	polyesterové vreco pre PVC box	1	168557-8	2,69 €

model	popis	ks/bal	Obj. č.	MOC s DPH
Elektrické pilníky *****				
	9032, DBS180	oporné rameno 9 × 533 mm	125158-5	38,19 €
		oporné rameno 13 × 533 mm	125159-3	87,79 €

model	popis	ks/bal	Obj. č.	MOC s DPH
Pásové brúsky *****				
	9903, 9920, 9403	stojan na brúsku	193055-3	92,09 €
	9404	brúsny rám	193072-3	118,99 €
	9903	brúsny rám	193070-7	91,29 €
	9401, 9402	držiak brúsky	342332-2	3,09 €
	9910, 9911	upínacie svorky	192694-6	61,89 €
	9404, 9902, 9903, 9920	zberné vreco na prach	122591-2	15,69 €
	9910, 9911	zberné vreco na prach	122548-3	6,19 €
	9924DB	zberné vreco na prach	122296-4	16,29 €
	9401, 9402	zberné vreco na prach	122297-2	15,19 €
	9403	zberné vreco na prach	122562-9	16,49 €

model	popis	Obj. č.	MOC s DPH	popis	Obj. č.	MOC s DPH	popis	Obj. č.	MOC s DPH
Pásové brúsky *****									
9401, 9402	oceľová doska	342328-3	3,09 €	korková doska	424058-9	1,12 €	grafitová doska	A-86262	3,69 €
9403	oceľová doska s korkom	150980-1	6,49 €	korková doska	424058-9	1,12 €	grafitová doska	424057-1	1,32 €
9404	oceľová doska s korkom	151751-9	8,66 €	korková doska	423314-4	2,89 €	grafitová doska	423317-8	5,79 €
9924DB				korková doska	423035-8	2,39 €	grafitová doska	423036-6	2,69 €
9902, 9903	oceľová doska s korkom	151749-6	5,39 €	korková doska	423312-8	1,69 €	grafitová doska	423315-2	10,79 €
9910, 9911	oceľová doska	345503-0	3,99 €						
9920	oceľová doska s korkom	151750-1	6,94 €				grafitová doska	423316-0	3,79 €

Tvar	Typ hlavy	Ø mm	pracovná dĺžka	upínanie	Obj. č.	MOC s DPH
------	-----------	------	----------------	----------	---------	-----------

Brúsne frézy pre priame brúsky

Karbid volfránu

Použitie

Štandardná hlava

Vlastnosti: vysoká účinnosť

Hrubé opracovanie

Použitie: kov, nerez



Diamantová Hlava

Vlastnosti: menej vibrácií

Jemné opracovanie

Použitie: kov, nerez



Neželezné kovy

Vlastnosti: menej zanášania

Hrubé opracovanie

Použitie: neželezné kovy, PVC



Tvar hlavy

Tvar: SA



Tvar: SC



Tvar: SF



Tvar: SL



Tvar: SM



Clean the burrs on inox



Deburr of aluminium



Wipe the welding line between steel plate



SA	diamant	10	20	6	B-52722	19,39 €
SC	diamant	10	20	6	B-52750	18,89 €
SF	diamant	10	20	6	B-52788	18,39 €
SL	diamant	10	25	6	B-52819	18,99 €
SM	diamant	10	20	6	B-52847	18,59 €
SA	štandard	10	20	6	B-52716	18,19 €
SC	štandard	10	20	6	B-52744	cena na vyžiadanie
SF	štandard	10	20	6	B-52772	14,49 €
SL	štandard	10	25	6	B-52803	18,69 €
SM	štandard	10	20	6	B-52831	18,39 €
SA	neželezné kovy	10	20	6	B-52738	17,99 €
SC	neželezné kovy	10	20	6	B-52766	17,89 €
SF	neželezné kovy	10	20	6	B-52794	16,99 €
SL	neželezné kovy	10	25	6	B-52825	18,09 €
SM	neželezné kovy	10	20	6	B-52853	16,99 €

model	klúč	upínanie	Obj. č.
-------	------	----------	---------

Klieštiny



DGD800, DGD801	13 mm 19 mm	3 mm	763669-8	20,59 €
		6 mm	763670-3	9,89 €
		8 mm	763671-1	17,69 €
		matica	763668-0	1,59 €
906	10 mm 17 mm	3 mm	763627-4	11,09 €
		6 mm	763620-8	8,39 €
GD0600, GD0601	13 mm x2	3 mm	763627-4	11,09 €
		6 mm	763620-8	8,39 €
		matica	763664-8	1,59 €
GD0603	10 mm x2	3 mm	763627-4	11,09 €
		6 mm	763620-8	8,39 €
		matica	763236-9	2,09 €
GD0602	13 mm x2	3 mm	763669-8	20,59 €
		6 mm	763670-3	9,89 €
		8 mm	763671-1	17,69 €
		matica	763668-0	1,59 €
GD0800/C, DGD800, DGD801, GD0810C, GD0801C, GD0811C	13 mm 19 mm	3 mm	*193011-3	26,59 €
		6 mm	*193012-1	20,99 €
		8 mm	*192988-9	27,89 €
		matica	763645-2	2,49 €

*sada klieština + matica

DVOJKOTÚČOVÉ BRÚSKY

Brúsne kotúče k dvojkotúčovým brúskam



model	typ/ zrnitosť	použitie	rozmer (mm)	Obj. č.	MOC s DPH
	A36M	železo	150 x 16 x 12,7	B-51904	13,89 €
	A60M	železo	150 x 16 x 12,7	B-51910	13,69 €
GB602	GC120H	tenké plechy Cu,Ni,Ms,Zn	150 x 16 x 12,7	B-51932	17,99 €
GB602W	A60M	železo	150 x 6,4 x 12,7	B-51895	12,19 €
GB801	WA60K	Železo/nerez	150 x 16 x 12,7	B-51926	16,49 €
	A36P	železo	205 x 19 x 15,88	B-51948	30,19 €
	A60P	železo	205 x 19 x 15,88	B-51954	25,49 €
	GC120H	tenké plechy Cu,Ni,Ms,Zn	205 x 19 x 15,88	B-51976	31,69 €
	WA60K	železo/nerez	205 x 19 x 15,88	B-51960	26,19 €





Akumulátory
 Odkladacie systémy
 Vŕtanie
 Skrutkovanie
 Brúsky
 Pílenie
 Frézovanie
 Brúsenie
 Špeciálne stroje
 Klince / spony
 Vysávanie
 Fény/lampy
 Záhrada
 Ručné náradie
 Ostatné

KEFOVÉ BRÚSKY

	popis	Zrnitosť	Obj. č.	MOC s DPH
Kotúče pre kefovú brúsku 9741				
	lamelová brúsna kefa na brúsenie povrchov, odstraňovanie farieb a pod.	40	P-01127	71,39 €
	kefa z oceleového drôtu, potiahnutá mosadzou, 0,3 mm pre vysoký úber vhodná na štruktúrovanie dreva, na odrezávanie a čistenie		P-65648	122,69 €
	drôtená kefa na leštenie železných plôch	120	794382-7	143,39 €
	kefa z oceleového drôtu 0,3 mm na odstraňovanie rezu a farieb, na čistenie betónového debnenia		P-04400	128,79 €
	fibrová kefa na zapracovanie moridiel a lakov + na následné vyhladenie		P-04416	104,69 €
	bavlnená leštiaca kefa na leštenie povrchových plôch aj s pridaním zodpovedajúcich leštiacich pást		794381-9	221,49 €
	brúsna nylonová kefa na štruktúrovanie mäkkého dreva a na dopracovávanie štruktúrovaní starého dreva pre zvýraznenie štruktúry dreva a na odstraňovanie existujúcich drevených vlákien pre optimálnu prípravu plôch na lakovanie a morenie pre zhotovenie brúsneho obrazu na ušľachtilej oceli a hliníku	60	P-04422	122,49 €
		80	P-04438	120,09 €
		120	P-04444	119,09 €
		180	P-04450	115,09 €
		80	794384-3	191,49 €
	valcová kefa vlies na jemné štruktúrovanie ušľachtilej ocele a jemné brúsenie povrchových plôch dreva	80	P-18035	66,49 €
		120	P-18041	66,29 €
		180	P-18029	65,89 €
	valcová kombinovaná kefa leinen/vlies na jemné štruktúrovanie ušľachtilej ocele a jemné brúsenie povrchových plôch dreva	80	P-18057	73,79 €
		120	P-19233	73,49 €
		180	P-19249	74,89 €
	nástavec na odsávanie		410899-9	1,19 €

Kotúče pre kefovú brúsku 9741



	oceľová kefa pre rýchly úber materiálu		D-73564	41,19 €
	oceľová kefa mosadzná úprava, pre brúsenie dreva a kovových materiálov		D-73570	41,19 €
	nylónová kefa na štruktúrovanie mäkkého a starého dreva, pre zvýraznenie štruktúr dreva pri príprave plôch pred lakovaním a morením a pre zhotovenie brúsneho obrazu ušľachtilej oceli a hliníku	60	D-73586	52,09 €
		80	D-73592	52,19 €

SPONKOVAČKY

typ	šírka (mm)	dĺžka (mm)	ks/bal	Vhodné pre stroj	Obj. č.	MOC s DPH
-----	------------	------------	--------	------------------	---------	-----------

Spony pre AT638

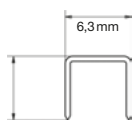

spony	6,3	25	5000	AT638	F-33607	28,09 €
spony	6,3	30	5000	AT638	F-33623	36,89 €
spony	6,3	32	5000	AT638	F-33636	34,39 €
spony	6,3	38	5000	AT638	F-33649	42,19 €

Spony pre AT1150A

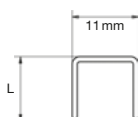

spony	11	25	10000	AT1150A	F-32078	73,69 €
spony	11	28	10000	AT1150A	F-32081	88,19 €
spony	11	32	10000	AT1150A	F-32094	102,09 €
spony	11	35	10000	AT1150A	F-32100	79,29 €
spony	11	40	10000	AT1150A	F-32113	92,49 €
spony	11	45	10000	AT1150A	F-32126	92,59 €
spony	11	51	10000	AT1150A	F-32139	150,99 €

Spony pre AT2550A

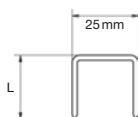

spony	25	25	10000	AT2550A	F-32023	100,09 €
spony	25	32	10000	AT2550A	F-32036	95,89 €
spony	25	38	10000	AT2550A	F-32049	147,09 €
spony	25	45	10000	AT2550A	F-32052	120,39 €
spony	25	51	10000	AT2550A	F-32065	115,49 €

Spony pre T221/DST220BST/DST221

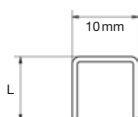

spona	10	8	5000		F-32917	11,89 €
spona	10	10	5000		F-32647	14,39 €
spona	10	13	5000		F-32650	16,29 €
spona	10	16	5000		F-32663	21,79 €
spona	10	19	5000		F-32676	15,89 €
spona	10	22	5000		F-32689	26,69 €

Spony pre ST113/DST112

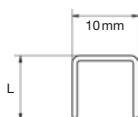

spona	10	7	2500		F-81518	4,19 €
spona	10	10	2500		F-81521	16,49 €



KLINCOVAČKY

typ	typ dráčku	šířka (mm)	délka (mm)	ks/bal	vhodné pro stroje	Obj. č.	MOC s DPH
-----	------------	------------	------------	--------	-------------------	---------	-----------

Klince do betónu pre AN250HC



klince do betónu		2,5	22	1000	AN250HC	F-33575	60,79 €
------------------	--	-----	----	------	---------	---------	---------

Klince pre AN450, AN454 (klince páskované pod 16° uhlom)

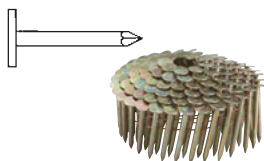

klince spájané drôtom	hladký	3,1	32	7200	AN450, AN454	F-30788	109,59 €
klince spájané drôtom	hladký	3,1	45	7200	AN450, AN454	F-30807	61,69 €

Klince pre AN560, AN611, AN621, AN635H, AN760, AN901, AN902, AN935H, AN953H

(klince páskované pod 16° uhlom)

klince spájané drôtom	hladký	2,5	45	10800		F-30810	90,29 €
klince spájané drôtom	hladký	2,5	50	10800		F-31243	156,39 €

Klince pre AN611, AN621, AN635H, AN760, AN901, AN902, AN935H, AN953H, AN960, AN961

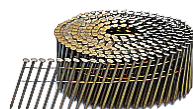

klince spájané drôtom	hladký	2,5	57	8100		F-31256	119,89 €
klince spájané drôtom	hladké	2,5	65	8100		F-30900	109,49 €
klince spájané drôtom	skrutkovité	2,5	65	8100		F-31269	151,89 €

Klince pre AN560, AN611, AN621, AN635H, AN760, AN901, AN902, AN935H, AN953H

klince spájané drôtom	skrutkovitý	2,9	50	9000		F-30971	156,09 €
-----------------------	-------------	-----	----	------	--	---------	----------

Klince pre AN611, AN621, AN635H, AN760, AN901, AN902, AN935H, AN953H, AN960, AN961



klince spájané drôtom	skrutkovitý	2,9	57	6750		F-31272	103,79 €
klince spájané drôtom	skrutkovitý	2,9	57	6750		F-30881	130,89 €
klince spájané drôtom	hladký	3,1	65	6750		F-30836	117,39 €
klince spájané drôtom	hladký	3,3	65	6750		F-30852	76,99 €

Klince pre AN760, AN901, AN902, AN935H, AN953H, AN960, AN961

(klince páskované pod 16° uhlom)

klince spájané drôtom	skrutkovitý	3,2	75	4050		F-31320	136,79 €
-----------------------	-------------	-----	----	------	--	---------	----------

Klince pre AN901, AN902, AN935H, AN953H, AN960, AN961

(klince páskované pod 16° uhlom)

klince spájané drôtom	hladký	3,4	75	3600		F-31359	109,09 €
klince spájané drôtom	hladký	3,1	85	4050		F-31304	150,79 €
klince spájané drôtom	hladký	3,1	90	4050		F-31317	130,49 €
klince spájané drôtom	skrutkovitý	3,2	90	4050		F-31346	132,69 €
klince spájané drôtom	hladký	3,8	90	2700		F-31362	122,89 €

typ	typ drieku	šírka (mm)	dĺžka (mm)	ks/bal	Vhodné pre stroje	Obj. č.	MOC s DPH
-----	------------	------------	------------	--------	-------------------	---------	-----------

Klince pre AN560, AN611, AN635H

(klince páskované pod 16° uhlom)

klince spájané drôtom	hladký	2,1	32	21600		F-32766	96,29 €
-----------------------	--------	-----	----	-------	--	---------	---------

Klince pre AN560, AN611, AN621, AN635H, AN760, AN901, AN935H

(klince D s hladkým driekom, páskované papierom pod 34° uhlom)

klince spájané drôtom	hladký	2,1	45	18000		F-32782	117,99 €
-----------------------	--------	-----	----	-------	--	---------	----------

Klince pre AN943



páskované papierom	hladký	2,9	60	3000		F-30566	58,79 €
páskované papierom	hladký	3,1	75	3000		F-30582	141,49 €
páskované papierom	hladký	3,3	75	3000		F-30614	85,09 €
páskované papierom	hladký	3,3	75	3000		F-30627	120,89 €
páskované papierom	hladký	3,1	83	3000		F-30601	91,89 €
páskované papierom	hladký	3,3	83	3000		F-30643	131,19 €
páskované papierom	hladký	3,3	90	3000		F-30656	93,69 €
páskované papierom	hladký	3,3	90	3000		F-31645	124,59 €

Klince pre AF505, AF506, DBN500, FN001G, DFN350

DFN350 klince len do dĺžky 35 mm (kolárske klince)

FN001G klince len do dĺžky 40 mm



kolárske klince	hladký	1	20	5000		P-45923	13,59 €
kolárske klince	hladký	1	25	5000		P-45939	15,69 €
kolárske klince	hladký	1	30	5000		P-45945	17,89 €
kolárske klince	hladký	1	40	5000		P-45951	21,29 €
kolárske klince	hladký	1	50	5000		P-45967	24,99 €
kolárske klince	hladký	1	15	5000		F-31867	12,99 €
kolárske klince	hladký	1	20	5000		F-31870	17,49 €
kolárske klince	hladký	1	25	5000		F-31883	16,49 €
kolárske klince	hladký	1	30	5000		F-31896	16,09 €
kolárske klince	hladký	1	35	5000		F-31915	18,59 €
kolárske klince	hladký	1	38	5000		F-31928	20,39 €
kolárske klince	hladký	1	40	5000		F-31931	20,69 €
kolárske klince	hladký	1	45	5000		F-31944	23,09 €
kolárske klince	hladký	1	50	5000		F-31957	25,59 €

SPONKOVAČKY

typ	typ drtičku	šířka (mm)	délka (mm)	ks/bal	vhodné pro stroj	Obj. č.	MOC s DPH
-----	-------------	------------	------------	--------	------------------	---------	-----------

Klince pre AF353, AF201Z, BPT/DPT350, BPT/DPT351, DPT353, PT354, PT001G

(Klince bez hlavičky – pinky)



klince – pinky	hladký	0,6	18	10000		F-31825	13,99 €
klince pozink	hladký	0,6	18	10000		F-32142	31,69 €
klince – pinky	hladký	0,6	25	10000		F-31838	14,89 €
klince pozink	hladký	0,6	25	10000		F-32155	38,69 €
klince – pinky	hladký	0,6	30	10000		F-31841	15,99 €
klince pozink	hladký	0,6	30	10000		F-32168	44,79 €
klince – pinky	hladký	0,6	35	10000		F-31854	18,79 €
klince pozink	hladký	0,6	35	10000		F-32171	48,49 €

Klince pre AN621



klince spájané drôtom	krúžok	2,5	45	9000		P-51487	132,69 €
klince spájané drôtom	krúžok	2,5	64	9000		P-51502	157,79 €
klince spájané drôtom	krúžok	2,5	50	9000		P-51493	138,39 €

Klince pre AN901



klince spájané drôtom	krúžok	2,8	65	5000		P-51524	105,09 €
klince spájané drôtom	krúžok	2,8	75	5000		P-51530	128,59 €
klince spájané drôtom	krúžok	3,1	90	4500		P-51552	157,99 €

model	popis	rozmer	Obj. č.	MOC s DPH
-------	-------	--------	---------	-----------

Ďalšie príslušenstvo ku sponkovačkám/klincovačkám

AN621, AN911, AN510H, AN610, AN620H, AN711H, AN911H	vsuvka H22PN		243105-5	15,07 €
AN902, AN901, AN621, AT1150, AT2250, AT638, AF201Z, AF505, AF506	vsuvka	1/2"	HY00000080	1,51 €
AN621, AN911, AN510H, AN610, AN620H, AN711H, AN911H, AT638, AT1150, AT2250	kompresorová vsuvka	1/4"	P-45989	9,29 €
AN943	kompresorová vsuvka	3/8"	243104-7	5,28 €
AT1150, AT2250, AF201, AN621, AN911, AN943	kompresorová hadica	ø 8 mm 15 m	P-45973	84,19 €
AN450, AN610, AN620, AN711, AN911	vysokotlaková hadica	7,5 m	B-80036	182,49 €
AN450, AN610, AN620, AN711, AN911	vysokotlaková hadica	15 m	B-80014	222,29 €
AN450, AN610, AN620, AN711, AN911	navijak na vysokotlakové hadice		B-80008	511,79 €
pre všetky klincovačky a sponkovačky	olej	30 ml	181434-7	1,79 €

PRÍSLUŠENSTVO PRE ŠPECIÁLNE STROJE MAKITA

typ	popis	Obj. č.	MOC s DPH
-----	-------	---------	-----------

Príslušenstvo pre BCG/DCG180, CG100

A: 300 ml



C: 800 ml



B: 600 ml



D: 400 ml



A	300 ml set	196351-8	38,09 €
B	600 ml set	1911T4-0	127,39 €
C	800 ml set	197195-9	95,19 €
D	400 ml set	191P89-6	95,89 €
A	držák 300 ml	454275-7	8,40 €
A	matica	454223-6	3,79 €
A	ozubené ťahlo	142041-1	35,12 €
B	matica	318958-2	5,89 €
B	tryska	454226-0	2,29 €
A, B	piestik	142071-2	2,62 €
A, B	piestik	142072-0	4,10 €
C	piestik	123221-8	19,55 €

ø (mm)	ks/bal	popis	Obj. č.	MOC s DPH
--------	--------	-------	---------	-----------

Príslušenstvo pre Aku viazač armatúr DTR180

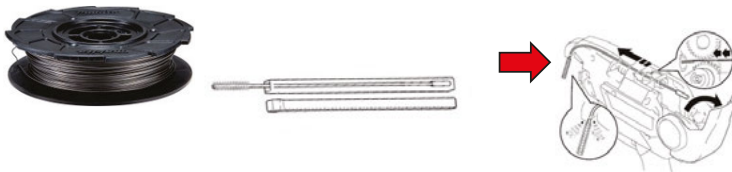

0,8	50	Žihany viazací drôt	199137-9	207,49 €
0,8	50	Žihany viazací drôt pozink	191A57-9	295,69 €
	1	kefka čistiaca	162755-6	32,29 €
	1	predĺženie	191M27-0	215,19 €

popis	Obj. č.	MOC s DPH
-------	---------	-----------

Príslušenstvo pre AKU kompresory DMP180, DMP181, MP001, MP100D



adaptér pre francúzske ventily	TE00000334	11,68 €
adaptér na lopty, nafukovačky	TE00000333	1,08 €
adaptér na lopty	TE00000335	1,39 €
adaptér pre anglické ventily	TE00000346	12,10 €
hadica	TE00000345	12,80 €

Príslušenstvo pre Aku maznicu DGP180

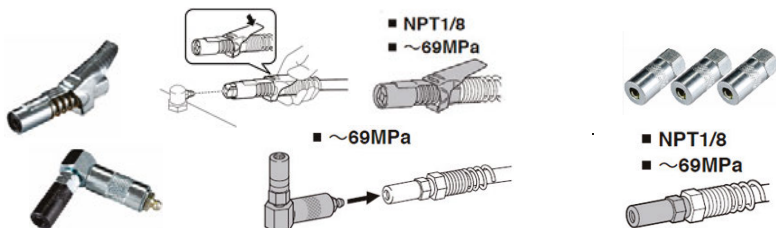

maznica s poistkou	191A76-5	138,69 €
maznica uhlová	191A77-3	83,49 €
sada maznic 3 ks	191W60-2	39,89 €
hadica 0,6 m	191A80-4	83,79 €
hadica 1,2 m	191W58-9	48,99 €

tuba pre kartuše a ručné plnenie 400 g	1910X0-0	111,49 €
tuba pre kartuše a ručné plnenie 450 g	191A81-2	cena na vyžiadanie
tuba pre kartuše a ručné plnenie 500 g	191F23-6	114,19 €
tuba pre 400 g kartuše	191F24-4	78,99 €
tuba pre 450 g kartuše	191F25-2	cena na vyžiadanie
tuba pre 500 g kartuše	191F27-8	74,99 €

PRISLÚŠENSTVO PRE DIEROVAČ DPP200

Ø (mm)	obj.č	MOC s DPH	Ø (mm)	obj.č	MOC s DPH	mäkká ocel	Náhrdzavajúca ocel
--------	-------	-----------	--------	-------	-----------	------------	--------------------

razník

matrica

hrúbka materiálu

Okrúhle dierovanie



6	SC05340040	110,79 €	SB6	SC00000203	113,69 €	t2-t4	t3-t4
8	SC05340060	112,19 €	SB8	SC00000207	112,99 €	t2-t6	t3-t4
10	SC05340080	111,19 €	SB10	SC00000211	112,09 €	t2-t6	t3-t4
12	SC05340100	128,29 €	SB12	SC00000215	157,99 €	t2-t8	t3-t6
14	SC05340120	110,59 €	SB14	SC00000219	111,39 €	t2-t8	t3-t6
15	SC05340130	cena na vyžiadanie	SB15	SC00000221	cena na vyžiadanie	t2-t8	t3-t6
16	SC05340140	109,79 €	SB16	SC05332710	110,59 €	t2-t8	t3-t6
18	SC05340150	110,29 €	SB18	SC00000223	110,59 €	t2-t8	t3-t6
19	SC05340170	cena na vyžiadanie	SB19	SC05332740	cena na vyžiadanie	t2-t8	t3-t6
20	SC05340160	108,49 €	SB20	SC05352510	109,29 €	t2-t8	t3-t6

razník

matrica

hrúbka materiálu

Oválne dierovanie



6.5 × 10	SC05340200	cena na vyžiadanie	6.5 × 10B	SC00000244	cena na vyžiadanie	t2-t6	t3-t4
6.5 × 13	SC05340210	153,29 €	6.5 × 13B	SC00000246	112,99 €	t2-t6	t3-t4
8.5 × 13	SC05340220	153,29 €	8.5 × 13B	SC00000248	112,99 €	t2-t6	t3-t4
8.5 × 17	SC05340230	cena na vyžiadanie	8.5 × 17B	SC00000250	cena na vyžiadanie	t2-t6	t3-t4
9 × 13.5	SC05340240	cena na vyžiadanie	9 × 13.5B	SC00000252	cena na vyžiadanie	t2-t6	t3-t4
9 × 18	SC05340250	cena na vyžiadanie	9 × 18B	SC00000254	cena na vyžiadanie	t2-t6	t3-t4
10 × 15	SC05340260	153,29 €	10 × 15B	SC00000256	112,99 €	t2-t8	t3-t6
10 × 20	SC05340270	cena na vyžiadanie	10 × 20B	SC00000258	cena na vyžiadanie	t2-t8	t3-t6
11 × 16.5	SC05340280	cena na vyžiadanie	11 × 16.5B	SC00000260	cena na vyžiadanie	t2-t8	t3-t6
12 × 18	SC05340290	153,29 €	12 × 18B	SC00000262	112,99 €	t2-t8	t3-t6
13 × 19.5	SC05340300	cena na vyžiadanie	13 × 19.5B	SC00000264	cena na vyžiadanie	t2-t8	t3-t6
14 × 21	SC05340310	cena na vyžiadanie	14 × 21B	SC00000266	cena na vyžiadanie	t2-t8	t3-t6

Príslušenstvo pre Aku nitovačky DRV150 / DRV250

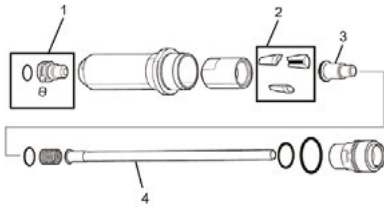

ø (mm)	typ	popis	Obj. č.	MOC s DPH
2,4	1	hlavička	127230-9	cena na vyžiadanie
	3	posúvač čeluste	127478-3	cena na vyžiadanie
	4	rúrka prepadu	162747-5	cena na vyžiadanie
	2	čeluste set 3 ks	199731-7	19,19 €
3,2	1	hlavička	127229-4	cena na vyžiadanie
	3	posúvač čeluste	127477-5	cena na vyžiadanie
	4	rúrka prepadu	162746-7	cena na vyžiadanie
	2	čeluste set 3 ks	199731-7	19,19 €
4,0	1	hlavička	127228-6	20,00 €
	3	posúvač čeluste	127476-7	cena na vyžiadanie
	2	čeluste set 3 ks	199731-7	19,19 €
	4,8	1	hlavička	127225-2
3		posúvač čeluste	127475-9	8,75 €
2		čeluste set 3 ks	199731-7	19,19 €
2,4	1, 3, 4	sada	199729-4	36,39 €
3,2	1, 3, 4	sada	199728-6	35,19 €
4,0	1, 3, 4	sada	191C04-2	17,49 €
4,8	1, 3, 4	sada	191C03-4	17,39 €

Príslušenstvo pre Aku nitovačky DRV250

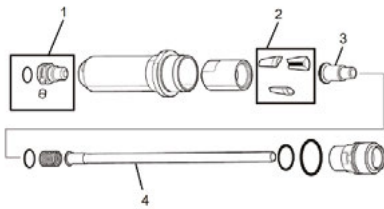

2,4	1	hlavička	127230-9	cena na vyžiadanie
	3	posúvač čeluste	127478-3	cena na vyžiadanie
	4	rúrka prepadu	162747-5	cena na vyžiadanie
	2	čeluste set 3 ks	199731-7	19,19 €
3,2	1	hlavička	127229-4	cena na vyžiadanie
	3	posúvač čeluste	127477-5	cena na vyžiadanie
	4	rúrka prepadu	162746-7	cena na vyžiadanie
	2	čeluste set 3 ks	199731-7	19,19 €
4,0	1	hlavička	127228-6	20,00 €
	3	posúvač čeluste	127476-7	cena na vyžiadanie
	2	čeluste set 3 ks	199731-7	19,19 €
	4,8	1	hlavička	127225-2
3		posúvač čeluste	127475-9	8,75 €
4		rúrka prepadu	162744-1	cena na vyžiadanie
2		čeluste set 3 ks	199731-7 199730-9	19,19 € 22,39 €
6,0	1	hlavička	127224-4	cena na vyžiadanie
	3	posúvač čeluste	127474-1	cena na vyžiadanie
	4	rúrka prepadu	162744-1	cena na vyžiadanie
	2	čeluste set 3 ks	199730-9	22,39 €
6,4	1	hlavička	127223-6	20,98 €
	3	posúvač čeluste	127473-3	8,89 €
	4	rúrka prepadu	162743-3	18,36 €
	2	čeluste set 3 ks	199730-9	22,39 €
2,4	1, 3, 4	sada	199729-4	36,39 €
3,2	1, 3, 4	sada	199728-6	35,19 €
4,0	1, 3, 4	sada	191F80-4	60,99 €
	1, 3, 4	sada	191C03-4	17,39 €
4,8	1, 3, 4	sada	191F79-9	31,09 €
	1, 3, 4	sada	199725-2	35,49 €
6,4	1, 3, 4	sada	191C02-6	cena na vyžiadanie



	DVR150	ochrana gumená	191G65-6	117,29 €
	DVR250	ochrana gumená	191G66-4	105,59 €

	popis	Obj. č.	MOC s DPH
AS001G príslušenstvo			
	Dýza fúkacia 3 mm	191X11-1	2,29 €
	Dýza fúkacia 7 mm	191X13-7	2,29 €
	Dýza fúkacia 13 mm	191X15-3	2,29 €
	Dýza tenká, vhodná na fúkanie plážových lôpt, nafukovačiek	191X17-9	3,19 €
	Dýza široká	191X19-5	5,69 €
	Ofukovacia hadička s tryskou, dĺžka 0,8 m, hrúbka 6 mm	191X21-8	14,49 €
	Predlžovacia flexi hadica	191X23-4	20,99 €
	Gumová dýza, vhodná na ofukovanie	191X25-0	4,99 €
	Adaptér 65 mm	191X27-6	5,09 €
	Filter, vhodný pri práci v prašnom prostredí	191X29-2	5,09 €
	Dýza dlhá tenká štrbinová 8 mm	191X78-2	cena na vyžiadanie

LASERY

Príslušenstvo pre Lasery



statív 1000 – 2700 mm (5,8" upínanie)	P-81315	336,69 €
statív 400-1100 mm so závitom 5/8"	TKOLM2000F	50,29 €
meracia tyč hliníková (4 m)	P-81309	84,49 €

SK102 / SK103 / SK104 / SK105 / SK106

nástenný držiak vrátane 1/4" skrutky	LE00785637	136,19 €
--------------------------------------	------------	----------

SK102Z, SK103PZ, SK104Z



magnetický držiak s 5/8" a 1/4" adaptérom	LE00785633	18,09 €
kĺbový adaptér 1/4" na 1/4"	LE00785519	25,39 €
detektor	LE00837085	198,09 €

SK102Z, SK103PZ, SK104Z, SK700, SK700D



taška (SK102Z)	LE00785636	cena na vyžiadanie
taška SK103PZ/SK104Z	LE00822220	cena na vyžiadanie
USB Power Supply Cable – SK105/SK106	199178-5	11,89 €
prijímač LDX1	LE00855702	274,79 €
magnetický terč	LE00785638	24,79 €

SKR200



prijímač	LE00796587	469,99 €
magnetický držiak	LE00784968	81,39 €
diaľkové ovládanie	LE00796588	cena na vyžiadanie
držiak na stenu s 5/8" skrutkou	LE00791661	106,69 €

SK312GD

taška	TKAK400MUN	cena na vyžiadanie
laserový prijímač LDG3	TKOLDG301G	cena na vyžiadanie
napájací kábel USB	199010-3	12,49 €
nástenný držiak	TK000ET03F	cena na vyžiadanie

PRÍSLUŠENSTVO ELEKTRICKÉ VYSÁVAČE

Obj. č.	MOC s DPH	ks/bal	typ	VC4210/LM	VC3511/LM	VC2000/VC2010 VC2511/VC2012 VC2512/VC3011	VC3211M/L VC3210/L VC3211H	VC3012/LM	446	447/LM	440, 448
Vrecká do elektrických vysávačov											
	W107418353	41,29 €	5	vrecko na prach z netkanej textilie	•						
	W107418354	222,19 €	1	vrecko na prach z netkanej textilie na opakované použitie	•						
	P-78293	41,19 €	5	vrecko na prach papierové		•					
	P-72899	33,49 €	5	vrecko na prach z netkanej textilie			•				•
	P-84078	38,39 €	5	vrecko na prach z netkanej textilie				•			
	P-70194	43,69 €	5	vrecko na prach papierové					•		•
	195558-3	28,29 €	5	vrecko na prach z netkanej textilie			•				
	P-70203	78,39 €	5	vrecko na prach papierové						•	
	195440-6	11,19 €	10	vrecko PVC			•				
	P-70297	44,59 €	5	vrecko PVC		•			•		•
	P-70306	57,29 €	5	vrecko PVC						•	
	W107418355	33,59 €	5	vrecko PVC	•						
Filtre do elektrických vysávačov											
	P-70219	43,29 €	1	fiter kartuš		•	•		•		
	P-70225	83,99 €	1	filter kartuš						•	
	W107418352	37,29 €	1	filter motora	•						
	196251-2	29,89 €	1	prachový, suché vysávanie			•				
	W107418351	75,19 €	1	hepa filter	•						
*len pre model VC3210; ** okrem modelu VC3210											
Hubice pre elektrické vysávače											
	P-81789	23,59 €	1	hubica na koberce 35 x 300 mm	•				•		
	W107402706	15,29 €	1	hubica na koberce 35 x 260 mm			•				
	W14295	3,39 €	1	hubica na vankúše			•				
	W107417892	90,09 €	1	hubica univerzálna		•	•		•	•	
	P-70471	13,09 €	1	hubica s kefou		•	•		•	•	
	195551-7	29,49 €	1	hubica univerzálna mokré/suché vysávanie				•			
	191657-9	12,79 €	1	hubica s kefou tvar „O“		•	•		•	•	
	60279BON	10,39 €	1	kefa kobercová pre základňu 60277BON					•	•	
	410306-2	2,09 €	1	hubica štrbinová 330 mm			•				
	W6084	4,89 €	1	hubica štrbinová 35 x 300 mm			•		•	•	
	P-72964	89,09 €	1	hubica na mokré vysávanie			•			•	
Rúry pre elektrické vysávače											
	W107418350	37,29 €	3	rúra vysávača 36 x 350 mm, chrómová	•	•	•		•	•	
	192562-3	7,99 €	1	rúra vysávača rovná, hliník				•			
	192563-1	9,29 €	1	rúra vysávača ohnutá, hliník				•			
	P-72942	33,99 €	2	rúra vysávača 36 x 520 mm, kov		•	•		•	•	
	P-70437	52,99 €	2	rúra vysávača 36 x 515 mm, chrómová	•	•	•		•	•	
Rukoväte pre elektrické vysávače											
	P-70346	36,49 €	1	rukoväť ohnutá 36 mm, chróm	•				•	•	
	P-72908	27,59 €	1	rukoväť s reguláciou			•				
	50096BON	16,19 €	1	rukoväť bez regulácie							•
	50095BON	8,79 €	1	regulácia k rukoväti 50096BON							•
	W107413340	19,99 €		rukoväť s reguláciou pre hadicu P-81739		•	•	•			
Hadice pre elektrické vysávače											
	02300BON	66,79 €	1	hadica ø 25 mm x 3 m							•
	01319BON	72,99 €	1	hadica ø 45 mm x 4 m							•
	195433-3	66,89 €	1	hadica ø 28 mm x 3,5 m				•			
	195434-1	72,09 €	1	hadica ø 38 mm x 2,5 m				•			
	P-70487	95,39 €	1	hadica ø 27 mm x 3,5 m					•	•	
	W15365	67,99 €	1	hadica s adaptérom P-70421, ø 36 mm x 4 m					•	•	
	192108-5	28,19 €	1	hadica ø 19 mm x 2,5 m							•
	P-84084	78,69 €	1	hadica ø 32 mm x 4 m	•				•		
	P-70487	95,39 €	1	hadica antistatická ø 27 mm x 3,5 m			•		•	•	
	P-70362	148,39 €	1	hadica antistatická ø 36 mm x 3 m			•		•	•	
	P-72914	80,59 €	1	hadica s integrovanou rukoväťou quick systém ø 32 mm x 3 m			•		•	•	
	P-72920	44,59 €	1	hadica s integrovanou rukoväťou quick systém ø 36 mm x 3 m			•		•	•	
	P-81739	41,59 €	1	hadica s integrovanou rukoväťou quick systém ø 32 mm x 3,5 m		•	•	•			
	01316BON	30,89 €	1	hadica s integrovanou rukoväťou ø 45 mm x 2 m							•

Akumulátory
Odkladacie systémy
Vrtánie
Skrutkovanie
Brúsky
Pílenie
Frézovanie
Brúsenie
Klince / spony
Špeciálne stroje
Vysávanie
Fény/lampy
Záhradná
Ručné náradie
Ostatné

PRÍSLUŠENSTVO PRE AKU TYČOVÉ VYSÁVAČE

Obj. č.	MOC s DPH	ks/bal	typ	DCL284/ CL107G	DCL285/ CL108G	DCL286/ CL109G	DCL287/ CL110G	CL106	CL107	CL108	CL114	CL117	DCL180/181	DCL182	DCL280/283	DVC360
Filtre, sáčky																
191D73-9	43,79 €	1	cyklónový filter	•	•						•	•			•	
191D75-5	37,69 €	1	cyklónový filter					•	•	•			•	•		
443060-3	0,79 €	1	prachvý filter plstený					•	•				•			
199966-0	8,51 €	1	prachvý filter nylonový	•					•							•
451208-3	1,69 €	1	predfilter nylonový	•				•	•			•	•			
199989-8	7,99 €	1	HEPA filter	•				•	•			•	•			•
198745-3	4,69 €	5	papierové sáčky		•				•		•			•		
166084-9	0,96 €	1	textilné vrečko na opakované použitie		•				•		•			•		
191T96-3	20,29 €	10	textilné vrečko na prach 5 l													•
191E39-5	14,53 €	1	HEPA filter													•
Hubice																
198532-0	26,39 €	1	podlahová / kobercová (biela)	•	•	•	•	•	•	•	•	•	•	•	•	•
198149-9	13,29 €	1	podlahová / kobercová (maslová)	•	•	•	•	•	•	•	•	•	•	•	•	•
198527-3	15,69 €	1	podlahová / kobercová (modrá)	•	•	•	•	•	•	•	•	•	•	•	•	•
A-59950	61,79 €	1	podlahová (biela)	•	•	•	•	•	•	•	•	•	•	•	•	•
122520-5	6,99 €	1	podlahová (maslová)	•	•	•	•	•	•	•	•	•	•	•	•	•
123486-2	11,69 €	1	podlahová (biela)	•	•	•	•	•	•	•	•	•	•	•	•	•
123488-8	11,79 €	1	podlahová (modrá)	•	•	•	•	•	•	•	•	•	•	•	•	•
199038-1	11,39 €	1	hubica na čalúnený nábytok (biela)	•	•	•	•	•	•	•	•	•	•	•	•	•
199041-2	8,59 €	1	hubica na čalúnený nábytok (modrá)	•	•	•	•	•	•	•	•	•	•	•	•	•
140H95-0	6,49 €	1	hubica na čalúnený nábytok 120 mm(modrá)	•	•	•	•	•	•	•	•	•	•	•	•	•
459056-4	3,09 €	1	hubica na auto koberec 120 mm (modrá)	•	•	•	•	•	•	•	•	•	•	•	•	•
191M30-1	cena na vyžiadanie	1	kefa na hrubé nečistoty (čierna)	•	•	•	•	•	•	•	•	•	•	•	•	•
451243-1	0,59 €	1	nadstavec štrbinový (modrá)	•	•	•	•	•	•	•	•	•	•	•	•	•
198990-0	2,39 €	1	nadstavec štrbinový 330 mm (modrá)	•	•	•	•	•	•	•	•	•	•	•	•	•
198552-4	6,29 €	1	hubica tvar O (maslová)	•	•	•	•	•	•	•	•	•	•	•	•	•
198553-2	5,59 €	1	hubica tvar O (modrá)	•	•	•	•	•	•	•	•	•	•	•	•	•
191D67-4	6,79 €	1	hubica tvar O (šedá)	•	•	•	•	•	•	•	•	•	•	•	•	•
140H94-2	4,69 €	1	hubica tvar O dlhá 360°d (modrá)	•	•	•	•	•	•	•	•	•	•	•	•	•
198537-0	5,59 €	1	kefa úzka podlhovastá (maslová)	•	•	•	•	•	•	•	•	•	•	•	•	•
Rúry vysávania																
140G19-0	24,79 €	1	rúra teleskopická hliník (590-942)	•	•						•	•			•	
191E30-3	cena na vyžiadanie	1	rúra flexi 440-1140 mm (čierna)	•	•						•	•			•	
191D77-1	7,69 €	1	rúra plastová 340 mm (čierna)	•	•						•	•			•	
123584-2	19,09 €	1	rúra teleskopická PVC 500-850 mm (biela)			•	•	•	•	•			•	•		
198559-0	20,72 €	1	rúra teleskopická PVC 500-850 mm (biela)			•	•	•	•	•			•	•		
451424-7	2,29 €	1	rúra plastová 465 mm (maslová)			•	•	•	•	•			•	•		
191D80-2	4,19 €	1	rúra plastová 340 mm (čierna)			•	•	•	•	•			•	•		
198544-3	7,09 €	1	rúra flexi 440-1140 mm (maslová)			•	•	•	•	•			•	•		
Držiaky																
458571-5	4,89 €	1	držiak na stenu	•	•	•	•	•	•	•	•	•	•	•	•	•
1911L1-0	cena na vyžiadanie	1	držiak vysávača	•	•	•	•	•	•	•	•	•	•	•	•	•

PRÍSLUŠENSTVO PRE AKU PODLAHOVÉ A CHRBTOVÉ VYSÁVAČE

Príslušenstvo pre DVC750



popis	Obj. č.	MOC s DPH
hubica	458891-7	cena na vyžiadanie
hubica štrbinová	458919-1	cena na vyžiadanie
hubica štrbinová dlhá	410306-2	2,09 €
hubica v tvare O	191657-9	12,79 €
hadica ø 28 mm x 2 m	140G04-3	10,29 €
popruh ramenný	199486-4	cena na vyžiadanie
adaptér ø 38 mm	418500-0	3,88 €
HEPA filter	162518-0	23,57 €
nylónový predfilter	162635-6	14,89 €
filter	422449-8	cena na vyžiadanie
filter na mokré vysávanie	191M39-3	18,19 €

Príslušenstvo pre DCL184/CL121



1 x textilné vrecko na prach	166084-9	0,96 €
5 x papierové vrecko na prach	198745-3	4,69 €
Flexi hadica vysávací	140H92-6	14,46 €
Nástavec s kefou 360°	140H94-2	4,69 €
Hubica na čalúnenie	140H95-0	6,49 €
Jednoramenný popruh	162544-9	cena na vyžiadanie
Štrbinový nástavec	422437-5	cena na vyžiadanie
Hubica na auto koberce	459056-4	3,09 €
Nástavec fúkára	140J64-3	cena na vyžiadanie

Filtre, sáčky

Obj. č.	MOC s DPH	ks/bal	typ	DVC261, 265	DVC660, 665	DVC150, 155, 157	VC000G, VC000G, VC005G	VC008G, VC009G	VC006GM, VC007GL
191C26-2	20,89 €	10	textilné vrecko na prach 6 l	•					
191C30-1	16,69 €	1	vrecko na opakované použitie 5,5 l	•					
197903-8	20,09 €	10	textilné vrecko na prach 2 l	•			•		
197899-3	28,19 €	1	vrecko na opakované použitie 1,5 l	•			•		
195432-5	9,89 €	10	igelitové vrecko na prach 45			•	•		
195557-5	21,99 €	5	textilné vrecko na prach 15 l			•	•		
1910Y4-9	36,69 €	5	textilné vrecko na prach 35 l					•	
1910R3-2	16,89 €	10	igelitové vrecko na prach 45					•	
191Y27-2	15,19 €	1	HEPA filter				•		
127725-2	9,34 €	1	HEPA filter	•					
191D12-9	14,04 €	1	HEPA filter		•				
191V70-3	36,29 €	1	HEPA filter s krytom				•		
197166-6	74,59 €	1	HEPA filter			•			
1911B7-8	40,94 €	1	HEPA filter					•	
191V69-8	53,29 €	1	pred filter nylónový				•		
195553-3	20,99 €	1	pred filter nylónový			•			
1911B5-2	14,39 €	1	pred filter nylónový					•	
144625-1	24,19 €	1	filter látkový				•		
191V71-1*	39,58 €	1	filter látkový				•		
140248-3	13,89 €	1	filter látkový			•			
191V68-0	11,98 €	1	pred filter penový				•		
1911B4-4	4,39 €	1	pred filter penový					•	

* len pre použitie s modelom VC005G

PRÍSLUŠENSTVO PRE AKU PODLAHOVÉ A CHRBTOVÉ VYSÁVAČE

Obj. č.	MOC s DPH	ks/bal	typ	DVC281, 285	DVC680, 665	DVC150, 155, 157	VC0083, VC0084, VC0085	VC0086, VC0087	VC0088, VC0089
Hubice									
195551-7	29,49 €	1	hubica univerzálna mokré/suché vysávanie	•	•	•	•	•	•
195549-4	22,89 €	1	hubica suché vysávanie	•	•	•	•	•	•
195550-9	19,59 €	1	hubica mokré vysávanie	•	•	•	•	•	•
123486-2	11,69 €	1	hubica podlahová	•					
127082-8	33,99 €	1	hubica podlahová	•	•	•	•	•	•
A-59950	61,79 €	1	hubica podlahová	•					
197901-2	7,09 €	1	mäkká gumová hubica	•	•	•	•	•	•
191657-9	12,79 €	1	okružlá kefa	•	•	•	•	•	•
410306-2	2,09 €	1	nadstavec štrbinový	•	•	•	•	•	•



Rúry vysávania									
127093-3	14,09 €	1	rukoväť pre hadice 28 mm quick systém	•	•	•	•	•	•
126756-8	9,49 €	1	rukoväť pre hadice 28 mm	•	•	•	•	•	•
140G19-0	24,79 €	1	rúra teleskopická hliník pre hadice 28 mm Quick systém 590-942 mm	•	•	•	•	•	•
123584-2	19,09 €	1	rúra teleskopická PVC pre hadice 28 mm 500-850 mm (biela)	•	•	•	•	•	•
A-34235	35,89 €	1	hadica flexi 28 mm, 1,5 m, s adaptérmý 22 a 38 mm,	•	•	•	•	•	•
195433-3	66,89 €	1	hadica flexi 28 mm, 3,5 m, s adaptérmý 22, 24, 38 mm,	•	•	•	•	•	•
195436-7	82,09 €	1	hadica flexi 28 mm, 5 m, s adaptérmý 22, 24, 38 mm,	•	•	•	•	•	•
195434-1	72,09 €	1	hadica flexi 38 mm, 2,5 m	•	•	•	•	•	•
192562-3	7,99 €	1	rukoväť hliník pre hadice 38 mm	•	•	•	•	•	•
192563-1	9,29 €	1	rúra hliník pre hadice 38 mm	•	•	•	•	•	•
195439-1	114,29 €	1	set (hadica 38 mm, rúra rovná, zahnutá, hubica podlahová, štrbinový nadstavec)	•	•	•	•	•	•

SADY

Obsah sady	Obj. č.	MOC s DPH
 <p>1. predĺžovacia trubica 2 ks 2. otočná prípojka chrómovaná 3. hubica kobercová 4. štrbinová hubica 5. hubica s kefou 6. hubica na vankúše 7. plastový držiak</p>	P-70312	114,49 €
<p>1. predĺžovacia trubica 2 ks 2. otočná prípojka chrómovaná 3. hubica podlahová 4. hadica priem. 36mm, 4 m</p>	P-70328	139,89 €
<p>1. predĺžovacia trubica 2 ks 2. hadica priem. 27mm, 3 m s prípojkou 3. hubica podlahová 4. štrbinová hubica 5. hubica s kefou 6. hubica na vankúše</p>	W302002734	99,89 €

Príslušenstvo pre DRC300



bočná kefa na tatami	191P26-0	cena na vyžiadanie
bočná kefa na podlahy	191P28-6	cena na vyžiadanie
hlavná kefa na podlahy	191P22-8	38,69 €
hlavná kefa na tatami	191P20-2	42,69 €
magnetická páska na ohraničenie 5 m	191P18-9	38,59 €
penová ochrana proti poškodeniu	191X35-7	cena na vyžiadanie

Príslušenstvo pre DRC200Z



páska na vytýčenie hranice (15 m rolka)	SH00000231(EU)	64,29 €
bočné kefy	SH00000065	67,32 €
výkonná kefa	SH00000063	91,49 €
kryt rotačnej kefy	SH00000064	38,44 €
filter	SH00000213	116,04 €

ROZMERY ADAPTÉROV NA ODSÁVANIE



popis	poznámka	Ø adaptéru (mm)	pre vysávač	Obj. č.	MOC s DPH
-------	----------	-----------------	-------------	---------	-----------

Adaptéry na hadice vysávačov



adaptér hadice (k vysávaču)	pre hadicu P-70487, ø 36 mm	58	446L, 447L, VC2010L, VC2511, VC3511L	P-70409	14,29 €
adaptér hadice (k vysávaču)	pre hadicu P-70362 a P-72920, ø 36 mm	58	446L, 447L, VC2010L, VC2511, VC3511L	P-70390	16,19 €
adaptér ku stroju antistatický (použitelný s krúžkom 213419-6)	pre hadicu s rýchlopínaním	25/38	446L, 447L, VC2010L, VC2511, VC3511L	P-70378	29,69 €
adaptér ku stroju antistatický (použitelný s krúžkom 213419-6)	pre hadicu s rýchlopínaním	38	446L, 447L, VC2010L, VC2511, VC3511L, VC4210L/M	W107418688	33,59 €
adaptér ku stroju antistatický (použitelný s krúžkom 213419-6)	pre hadicu P-70487, ø 27 mm	37/45	446L, 447L, VC2010L, VC2511, VC3511L	P-70415	10,59 €
O krúžok	pre adaptéry ku strojom			213419-6	2,50 €
antistatický adaptér	pre hadicu P-70487, ø 27 mm	25/38	446L, 447L, VC2010L, VC2511, VC3511L	P-70421	24,59 €
adaptér	pre hadicu P-72914, ø 32 mm	25/38	446L, 447L, VC2010L, VC2511, VC3511L	P-72936	12,79 €
adaptér 22	pre hadicu 195433-3, ø 28 mm	22	VC3210LX1, BCV340, BCV350	195547-8	2,19 €
adaptér ku stroju 24	pre hadicu 195433-3, ø 28 mm	24	VC3210LX1, BCV340, BCV350	195546-0	3,29 €
adaptér 38	pre hadicu 195433-3, ø 28 mm	38	VC3210LX1, BCV340, BCV350	195545-2	6,49 €
adaptér 22	pre hadicu 195433-3 priemer 28 mm	22	VC3210, VC3211, BCV340, BCV350, DVC860L, VC2211M	195547-8	2,19 €
adaptér 22	pre hadicu 195433-3 priemer 28 mm	24	VC3210, VC3211, BCV340, BCV350, DVC860L, VC2211M	195546-0	3,29 €
adaptér s reguláciou	pre hadicu P-81739 priemer 32 mm	25/38	VC2012L, VC2512L, VC3011L	P-81745	21,99 €
adaptér ku stroju	pre hadicu Ø 32 mm	32/22	VC2012L, VC2512L, 3011L, VC2000L	W107418661	21,49 €
adaptér ku stroju	pre hadicu Ø 32 mm	32/38	VC2012L, VC2512L, 3011L, VC2000L	W107418680	20,29 €

Odsávanie

Len pre sekacie Ø hadice 28 mm na priame pripojenie



odsávanie príslušenstvo pre SDS-MAX 40 – 45 mm
vrtanie / sekacie

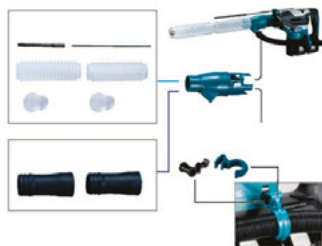

Odsávacie adaptéry pre vŕtacie kladivá

Odsávacie adaptéry pre vŕtacie kladivá
Tento systém je navrhnutý tak, aby efektívne
zachytával prach pri zapnutí / vypnutí nástrojov



model	Obj. č.	MOC s DPH	
DHR400, HM001G, HM002G, HR005G, HR006G, HM0830, HM0870C, HM0871C, HM1101C, HM1111C, HM1201, HM1203C, HM1205C, HM1213C, HM1214C, HR3530, HR3540C, HR3541FC, HR4001C, HR4002, HR4003C, HR4010C, HR4011C, HR4013C, HR4030C, HR4041C, HR4501C, HR4510C, HR4511C, HR5212C, HR5202C	odsávací set bez hadice	199143-4	15,29 €
HM1304/B, HM1306, HM1307C/CB, HM1317C/CB, HM1400, HM1500/B, HM1801, HM1802, HM1810, HM1812	odsávací set s hadicou	197148-8	cena na vyžiadanie
	odsávací set bez hadice	197168-2	49,39 €
HM1501, HM1502, HM1511, HM1512	odsávací set s hadicou	191M20-4	63,99 €
	odsávací set bez hadice	191M21-2	23,09 €
HR006G		191N81-0	cena na vyžiadanie
HR4001C, HR4002, HR4010C, HR4011C, HR4501C, HR4510C, HR4511C		196074-8	cena na vyžiadanie
HR5212C, HR5202C		196858-4	88,19 €

HEPA filtre pre odsávacie adaptéry



DHR182	DX05	199664-4	cena na vyžiadanie
DHR243	DX07	199572-1	132,99 €
DHR280, DHR282	DX08	199581-0	166,09 €
HR3011F	DX10	191F49-8	48,49 €
HR3012F	DX11	191F49-9	cena na vyžiadanie
HR001G, HR003G	DX12	191E54-9	155,69 €
HR002G, HR004G	DX14	191E60-4	169,39 €
HR2652, HR2653, HR2653T, HR2663		127185-8	cena na vyžiadanie
DHR242, HR2650, HR2651, HR2652, HR2653, HR2661, HR2663, DHR281, DHR283, HR002G, HR004G, HR3012FC, DHR243		195173-3	6,69 €
DHR242, HR2650, HR2651, HR2652, HR2653, HR2661, HR2663, DHR281, DHR283, HR002G, HR004G, HR3012FC, DHR243		195179-1	8,39 €
HR140D, HR166D, DHR164, DHR165, DHR171, DHR182, DHR263, DHR264, DHR202, DHR262, HR1840, HR2020, HR2460, HR2460F, HR2470FT, HR2470T, HR2470, HR2470F, HR2475, HR2800, HR2810, HR2810T, HR2811F, HR2811FT,		193472-7	48,79 €

Manžety



DX06, DX07, DX08, DX09, DX10, DX11, DX12, DX14, HR2652, HR2653, HR2653T, HR2663		199557-7	11,59 €
DX05		199596-7	8,39 €
filter s oklepom pre DX05		199595-9	60,23 €

DX05, DX06, DX07, DX08, DX09, DX12, DX14, HR2652, HR2653, HR2653T, HR2663		424474-5	0,79 €
protiprachový kryt pre stopku vŕtáka sekáča Ø 6 – 14 mm		421342-3	1,69 €
protiprachový kryt pre stopku vŕtáka sekáča Ø 10 – 18 mm		421664-1	2,39 €

Pripojenie stroja k vysávačom

*len pre modely DVC261, DVC265, DVC660, DVC66

Model VC002GL VC004GL DVC157L DVC867L VC006GM VC007GL		Model VC3211H VC3211M VC2211M VC3210L VC2510L VC1310L		Model VC009G DVC265 DVC665 DVC350		Model DVC750L		Model VC3012L/M VC4210L/M		Model VC2012L VC2512L VC3011L	
--	---	--	---	--	---	-------------------------	--	--	---	---	---

Hadica 28 mm 1.0m *143787-2 bez koncovky hadice 1.5m A-34235 s koncovkou hadice 22, 38 2.5m 195437-5 s koncovkou hadice 22, 24, 38 3.5m 195433-3 s koncovkou hadice 22, 24, 39 5.0m 195436-7 s koncovkou hadice 22, 24, 40 5.0m A-34229 s koncovkou hadice 22, 38		Hadica 38 mm s adaptérom 38 1.5 198757-6 2.5 195434-1 5.0 195435-9		32-B Hadica 32 mm 4m P-84084		32-B Hadica 32 mm 3.5m P-81739	
--	---	---	---	--	---	--	---

Koncovka hadice Koncovka hadice 38 195545-2 Koncovka hadice 22 195547-8		Koncovka hadice 24 195546-0		Redukcia 22 - 38 195548-6		Koncovka hadice 24 195546-0		Adaptér Quicksystem ø24 (set) P-70378 Quicksystem ø38 (set) W107418688		Adaptér	
--	---	---------------------------------------	---	-------------------------------------	---	---------------------------------------	---	---	---	----------------	---

Odsávacie adaptéry



AWS
Auto-start Wireless System





Modul AWS Bluetooth





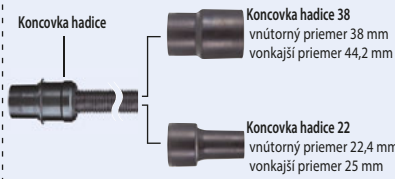
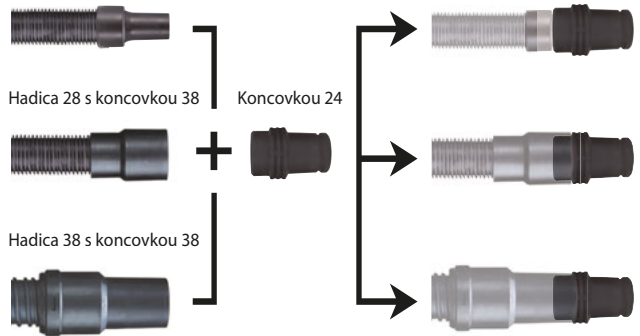

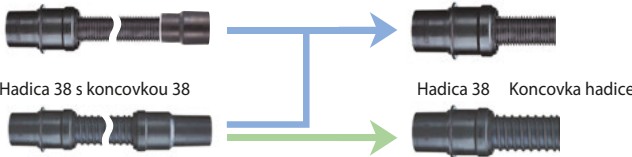

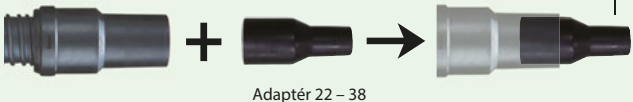

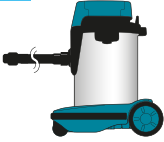
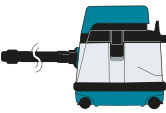



WUT02
Adaptér na prepojenie elektrických vysávačov s akumulátorovými strojmi



Adaptéry, redukcie a pripojenie hadíc

Hadica 28 mm Dodávaná s dvomi adaptéromi 22 a 38		Koncovka hadice Koncovka hadice 38 vnútorný priemer 38 mm vonkajší priemer 44,2 mm Koncovka hadice 22 vnútorný priemer 22,4 mm vonkajší priemer 25 mm		Koncovka 22, 24, 38 Hadica 28 s koncovkou 22 Hadica 28 s koncovkou 38 + Koncovkou 24 Hadica 38 s koncovkou 38	
Hadica 38 mm		Koncovka hadice Koncovka hadice 38 vnútorný priemer 38 mm vonkajší priemer 44,2 mm		Prepojenie hadice s hadicou Hadica 28 s koncovkou 38 Hadica 38 s koncovkou 38	
Adaptér 22 - 38 Hadica s koncovkou 38		Adaptér 22 - 38		Rozmery vnútorný priemer 22,4 mm vonkajší priemer 25 mm	

A	B	C	D	E	F	G
						
W/ Ø28mm Hadica	W/ Ø28mm Hadica	W/ Ø28mm Hadica	W/ Ø38mm Hadica	W/ Ø28mm Hadica	W/ Ø32mm Hadica	W/ Ø32mm Hadica
Model VC3211H VC3211M VC2211M VC3210L	Model VC002GL VC1310L VC004GL DVC157L DVC867L VC2510L	Model DVC350	Model VC001GL DVC860L VC003GL DVC861L VC005GL DVC865L DVC155L DVC866L DVC156L DVC750L	Model VC008G DVC261 VC009G DVC265 DVC660 DVC665	Model VC2012L VC2512L VC3011L	Model VC3012L VC4010L VC3012M VC4010M
S koncovkou hadice	S koncovkou hadice	S koncovkou hadice	W/ Joint 22-38	S koncovkou hadice	W/ Tool adapter 24	Adapter 38 (option)
						
38 24 22	38 24 22	38 24 22		38 24 22	P-81745 P-70421	P-70378 W107418688

Vrtáče a búracie kladivá



A
B
C
D
E

Koncovka hadice 22 or 38

F
G

Adaptér 24

A
B
C
D
E

Koncovka 22

F
G

Adaptér 24

	Model	Prevádzkový režim	Odsávací adaptér		Koncovka / hadice veľkosť
			Typ	Obj. č.	
Búracie kladivá	HM1501, HM1502, HM1511, HM1512	---	bez hadice	191M21-2 191M23-8**	Hadica 28 bez koncovky
			s hadicou	191M20-4 191M22-0**	Koncovka 24 alebo 38
Búracie kladivá	HM1304/B, HM1306, HM1303C/CB, HM1307C/CB, HM1317C/CB, HM1400, HM1500/B, HM1801, HM1802, HM1810, HM1812	---	bez hadice	197168-2 197170-5**	Hadica 28 bez koncovky
			s hadicou	197148-8 197172-1**	Koncovka 24 alebo 38
Sekacie kladivá	HM001G, HM002G, HM0830, HM0870C, HM0871C, HM1101C, HM1111C, HM1201, HM1203C, HM1205C, HM1213C, HM1214C	---	bez hadice	199143-4 199017-9**	Hadica 28 bez koncovky
			s hadicou	199142-6 199014-5**	Koncovka 24 alebo 38
Kombinované kladivá	DHR400, HR005G	Sekanie / vrtanie	-	197148-8 197172-1**	Koncovka 22
	HR4013C, HR4003C		-	196858-4	Koncovka 22
	HR5212C, HR5202C	Sekanie / vrtanie	-	191N81-0 191N82-8**	Koncovka 22
	HR006G	Sekanie / vrtanie	-	196074-8	Koncovka 22
	HR4001C, HR4002, HR4010C, HR4501C, HR4510C, HR4511C,	Sekanie / vrtanie	-	199144-2 199019-5**	Koncovka 24 alebo 38
HR5212C, HR5202C, HR4001C, HR4002, HR4010C, HR4501C, HR4510C, HR4511C, HR4041C, HR4030C, HR4013C, HR4003C	Sekanie	s hadicou	199143-4 199017-9**	Hadica 28 bez koncovky	
HR3541C, DHR400, HR005G, HR006G		bez hadice			

Model	Prevádzkový režim	Odsávací adaptér		Koncovka / hadice veľkosť
		Typ	Obj. č.	

Kombinované kladivá	HR140D, HR166D, DHR164, DHR165, DHR171, DHR182, DHR202, DHR262, DHR263, DHR264, HR1840, HR2020, HR2022, HR2230, HR2460, HR2460F, HR2470, HR2470F, HR2470FT, HR2470T, HR2475, HR2800, HR2810, HR2810T, HR2811F, HR2811FT,	Vrtanie	Odsávací adaptér	193472-7	Koncovka 22
	*DHR164, *DHR165, *DHR171, *DHR182, *DHR202, *DHR241, *DHR262, DHR263, *HR1840, *HR1841F, *HR2230, HR2460, *HR2460F, HR2470, HR2470F, HR2475, HR2800, HR2810, HR2811F	Sekanie / vrtanie	Zberný adaptér	198362-9	Koncovka 22
	DHR242, DHR280, DHR282, HR001G, HR003G, HR2300, HR2600, HR2601, HR2601F, HR2630, HR2631F, HR2641, HR2651, HR2652, HR2653, HR2663, HR3001C, HR3011F, HR007G	Sekanie / vrtanie	Zberný adaptér	195173-3	Koncovka 22
	DHR243, DHR281, DHR283, HR002G, HR004G, HR2320T, HR2630T, HR2631FT, HR2653T, HR3012F	Sekanie / vrtanie	Zberný adaptér	195179-1	Koncovka 22

Kotúčové píly a ponorné píly

*potrebná aj vnútorná príruka



* nie je potrebná koncovka hadice 24



Model	Adaptér		Koncovka
	Popis	Obj. č.	
DHS630	Odsávací adaptér	194314-8	22
DHS631	Odsávací adaptér	196995-4	22
DHS660, DHS661	Odsávací adaptér	199230-9	24
DHS680, HS012G	Odsávací adaptér	196961-1	24
DHS710	Odsávací adaptér	196520-1	24
DHS711	Odsávací adaptér	196843-7	24
DHS780, DHS781, DHS782, DHS783	Odsávací adaptér	196520-1	24
HS009G, HS010G, HS011G	---	---	24
DHS900, DHS901, DSP600, DSP601	---	---	24
DSS501	Odsávací adaptér	194415-2	22
DSS611	Odsávací adaptér	199460-2	22
RS001G	---	---	24
RS002G, 5017RKB	---	---	38
5007F, 5007FA, 5007NB	Odsávací adaptér	199711-3	24
5007MGA, 5007MG	Odsávací adaptér	199716-3	24
5007N, 5007NF	Odsávací adaptér	199712-1	24
5008MG, 5008MGA	Odsávací adaptér	194489-3	38
5103R	Adaptér s 2 x skrutkou	415426-7/ 192419-8	38
5104, 5104S	Adaptér	199427-0	38
5143R	Adaptér	192490-2	38
N5900B, 5902B	Adaptér	193068-4/ 193823-4	38
5903R	Adaptér	192419-8	38
HS003G, HS004G	Odsávací adaptér	196520-1	24
HS301D	Odsávací adaptér	195334-5	22
HS0600	Odsávací adaptér	198263-1/ 198265-7	24
HS6100, HS6101	Odsávací adaptér	195801-0	24
HS6600	Odsávací adaptér	196843-7/ 196520-1	24
HS6601	Odsávací adaptér	196520-1	24
HS7000	Odsávací adaptér	197221-4/ 196520-1	24
HS7010	Odsávací adaptér	196520-1	24
HS7100, HS7101	Odsávací adaptér	195801-0	24
HS7600	Odsávací adaptér	197221-4/ 196520-1	24
HS7010, HS7610, HS7611	Odsávací adaptér	198933-2	24
HS7601, HS7610, HS7611	Odsávací adaptér	196520-1	24
SP6000, SP001G	---	---	24

Uholové brúsky





















Model	Kryt kotúča na zachytávanie prachu		Koncovka
	Typ krytu kotúča	Obj. č.	
pre uhl. brúsky 115/125 mm	C	196845-3	38
125 mm modely X-Lock	C	191G05-4	38
pre uhl. brúsky 115/125 mm, bez nástrojová výmena	C	191G06-2	38
pre uhl. brúsky 180/230 mm	D	198379-2(M14 spindle) 198440-5(EU) 198509-5 (5/8" spindle) 198510-0 (M16 spindle)	38
pre uhl. brúsky 180/230 mm	B	194044-1	38

Uholové brúsky / diamantové brúsenie















Model	Kryt kotúča pre diamantové brúsenie		Koncovka
	Priemer kotúča	Obj. č.	
125 mm modely X-Lock	125mm	191F81-2	38
pre uhl.brúsky 115/125 mm	125mm	127147-6	38
pre uhl.brúsky 180/230 mm použitie len 180 mm brúsny kotúč	180mm	195385-8	38

Akumulátory
Odkladacie systémy
Vrtanie
Skrutkovanie
Brúsky
Pílenie
Frézovanie
Brúsenie
Klince / spony
Špeciálne stroje
Vysávanie
Fény/lampy
Záhraďa
Ručné náradie
Ostatné

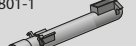
Model	Systém prepojenie s vysávačom
Pásová brúska DB5180, 9032 	Adaptér 122652-8 
Pásová brúska 9031 	
Vibračné brúsky DBO380, DBO381, DBO480, DBO481, DBO482 9046, BO3700, BO3710, BO3711, BO4900/V, BO4901 BO4555, BO4556, BO4558, BO4566, BO4557, BO4558  	
Excentrické brúsky BO5012, BO5030, BO5031, BO5040, BO5041, BO6030, BO6040, DBO180 	
Multi Tool DTM52 ————— 191R02-6 DTM51 ————— 199627-2 DTM50 ————— 199621-4 TM3000C ————— 199618-3 TM3010C ————— 199624-8   	Odsávacie adaptéry 
Pásová brúska 9404, 9902, 9903, 9910, 9911, 9920, 	
Excentrická brúska BO6050 	Koncovka hadice 24 195546-0 
Brúska na sádrokartón DSL800, DSL801 	Koncovka hadice 24 195546-0 









*Nie je potrebný pri koncovke hadice 24

Model	Systém prepojenie s vysávačom
Priamočiare píly JV100D, JV143D JV183D, 4326, 4327, 4328, 4329 JV0600  	Koncovka 22 
Priamočiare píly DJV180, 4350T/CT/FCT, 4351T/CT/FCT  	Odsávací adaptér 417853-4 
Akumulátorové priamočiare píly DJV181, DJV182 ————— 126331-0 **JV102D, JV103D ————— 457801-1  	Odsávací adaptér 126331-0 457801-1  
Pila na kov DCS553 	Kryt komplet 









**Použitie s krytom 458191-5

*Nie je potrebný pri koncovke hadice 24



Model	Systém prepojenie s vysávačom
Uhlová rezačka 4112H, 4112HS, 4114, 4114S	Zahnutý adaptér 32 192613-2 
Diamantová rezačka 4100KB	
Akumulátorová diamantová rezačka DCC500	
Píla so zberným zásobníkom 4157KB	
Drážkovacie frézy SG1251, SG1250	
Leštička PC5000C, PC5001C, PC5010C	
Pásová brúska 9924DB	Adaptér 32 192518-6 
Pásová brúska 9403, 9921	Adaptér 32 192349-3 
Keľová brúska 9741	Adaptér 410899-9 



Model	Systém prepojenie s vysávačom
Akumulátorové pokosové píly DLS713, DLS714	
Pokosové píly LS0714/F/FL/L, LS0815F/FL, LS1016L, LS1017L, LS1018/L, LS1216/L	
Pokosové píly LS1030N, LS1440	
Pokosové píly LS1040/F, LS1045, LS1221	
Akumulátorové pokosové píly DLS600	
Stolové pokosové píly LH1040/F, LH1201FL	
Pokosové píly LS1019/L, LS1219/L	Koncovka hadice 195546-0 
Akumulátorové pokosové píly LS002G, LS003G, LS004G, DLS110, DLS111, DLS112, DLS211, DLS212	



Model	Systém prepojenie s vysávačom
Stolová píla 2704N, 2705	Adaptér 419093-0
Stolová píla 2703	Adaptér 55 192799-2
Stolová píla MLT100N	Adaptér JM27000090
Stolová píla 2712	
Pásová píla LB1200F	Adaptér 419093-0



Hoblovačka 2012NB	Odsávací adaptér 193036-7 Vonkajší priemer 76 mm
-----------------------------	---

Pre odsávacie hadice s vnútorným priemerom 76 mm



Model	Systém prepojenie s vysávačom
Hoblíky KP001G, DKP181, KP0810/C	Koncovka 38
Hoblíky DKP180, KP0800	Adaptér 451329-1
Hoblíky 1805N	Adaptér JPA122277
Hoblíky 1100	Adaptér 415452-6
Hoblíky 1911B	Adaptér 192082-7
Hoblíky N1900B, N1923B, KP0800, 1804N, 1805N, 1806B, KP312/S	Adaptér 38



*C: DVC350 nie je možné použiť s hoblíkmi

Odsávací adaptér

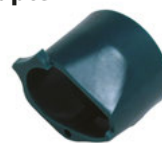

Adaptér









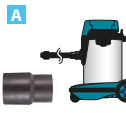
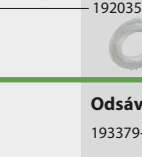

*Zahnutý

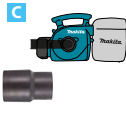

Model	Obj. č.	Model	Obj. č.
N1900B	191569-6	N1900B, N1923B	192799-2 JPA122275
N1923B	152464-5		
KP0800, DKP180, DKP140	451329-1	DKP180, DKP181, KP0810/ C, KP0800	*191C20-4
1804N	JPA122278 (122278-6)		
1805N	JPA122277 (122277-8)	1804N, 1805N, 1806B, KP312/S	181575-9
1806B	414499-7		
KP312/S	193733-5		

Model	Systém prepojenie s vysávačom
Lamelovacia fréza PJ7000, DPJ180 	A  Koncovka 22
Jednoručná fréza 3706 Odsávací adaptér 193449-2 	B  Koncovka 22
Akumulátorová ručná fréza DCO181, DCO180 	C*  Koncovka 22
Akumulátorová píla na sádrokartón DSD180, SD100D 	D  Adaptér 22-38 195548-6
Horné frézy RP1111C, RP1110C, RP0910 	E  Koncovka 22
	F  Adaptér 24 + Adaptér 25-50 192349-3
	G  Adaptér 38 + Adaptér 22-38 195548-6

*C: DVC350 nie je možné použiť s frézami

Model	Systém prepojenie s vysávačom
Horné frézy RP1802/ F, RP1803/ F, RP1801/ F, RP1800/ F, RP2302FC, RP2303FC RP2301FC, RP2300FC 	Odsávací adaptér 194934-8 A  Koncovka 38
3612BR 	B  Koncovka 38
Horné frézy RD1101, RF1101, RP1101 	Odsávací adaptér 193379-7 C  Koncovka 38
Horné frézy RP0900, **RT0700C, ***RT0702C Akumulátorové horné frézy ***RT001G, ***DRT50 	Odsávací adaptér 194733-8 D  Koncovka 38
*** len spoužitím ponornej základne Horná fréza RT0700C 	E  Koncovka 38
Akumulátorové horné frézy RT001G, DRT50 	F  Koncovka 38
Horná fréza RT0700C 	Odsávací adaptér 195559-1 G  Adaptér 38

Spoločnosť Makita odporúča použiť hadicu s priemerom 38 mm pri frézach



Popis	Obj. č.	MOC s DPH
-------	---------	-----------

Príslušenstvo pre modely HG6031, HG6030, HG5030, HG6530, HG6531



dýza chrániaca sklo pred poškodením	PR00000028	6,79 €
dýzy plochá	PR00000029	6,29 €
dýzy odrazová	PR00000030	7,49 €
dýzy pre zváranie preplátovaním	PR00000032	15,69 €
dýza pájkovacia odrazová	PR00000033	16,69 €
dýza zváracia	PR00000034	7,49 €
valček prítlačný	PR00000035	11,49 €
tavné tyčinky ABS použitie v automobilovom priemysle	PR00000036	cena na vyžiadanie
tavné tyčinky HDPE polyetylén s vysokou hustotou	PR00000037	cena na vyžiadanie
tavné tyčinky PP pre materiály z polypropylénu tavná teplota 250-310°	PR00000038	10,29 €
dýza pre rýchle zváranie, použitie len s dýzou	PR00000039	8,19 €
škrabka plochá	PR00000040	cena na vyžiadanie
škrabka sada 4 ks	PR00000041	9,99 €
škrabka	PR00000042	13,39 €

	model	výška	popis	upevňovacia skrutka	Obj. č.	MOC s DPH	Akumulátory
	DML805	992 – 1 750 mm	stojan lampy, možnosť pripevniť dve lampy	M8	GM00002283	79,79 €	Odkladacie systémy
	ML009G, ML003G, ML005G, DML809, DML811	1.300 - 2.000 mm	stojan lampy, možnosť pripevniť jednu lampu	M10	GM00002378	205,39 €	Víťanie
	DML809, DML811, ML003	1 300 – 2 000 mm	stojan lampy, možnosť pripevniť dve lampy	M10	GM00002073	214,79 €	Skrutkovanie
	ML105, ML104		magnet		GM00001683	19,59 €	Brúsky
	DML801, DML816, ML006G		difúzor svetla		GM00001326	cena na vyžiadanie	Pílenie
	DML809		difúzor svetla		GM00002286	20,89 €	Frezovanie
	DML811		difúzor svetla		GM00002287	14,69 €	Brúsenie
	ML005G		difúzor svetla		GM00002358	13,59 €	Klince / spony
	ML009G		difúzor svetla		GM00002377	8,49 €	Špeciálne stroje
	ML009G		Anti reflexná fólia		GM00002376	12,79 €	Vysávanie
	ML005G		Anti reflexná fólia		GM00002359	7,89 €	Fény/lampy

Príslušenstvo k Akku kávovaru DCM501



popis	Obj. č.	MOC s DPH
hrnček	KF00000020	13,39 €
viečko hrnčeka	KF00000021	1,55 €
dávkovač kávy	KF00000033	1,50 €

Ostatné

Ručné náradie

Fény/lampy

Vysávanie

Špeciálne stroje

Klince / spony

Brúsenie

Frezovanie

Pílenie

Brúsky

Skrutkovanie

Víťanie

Odkladacie systémy

Akumulátory

PRÍSLUŠENSTVO

▣ Príslušenstvo pre záhradu



Matice nožov, podložky, misky



*** podložka s ochranou proti namotaniu trávy

Model	Veľkosť vretena / tvar		1 Podložka			2 Upínacia podložka noža		3 Miska noža		4 Matica noža
			Vŕtanie noža (mm)	Priemer (mm)	Obj. č.	Priemer (mm)	Obj. č.	Priemer (mm)	Obj. č.	Obj. č.
DUR365U, DUR366L, UR006G, UR007G	M10x1.25LH	Ozubené 10T	25.4	42	**326518-6	50	346084-7	68	168526-9	264025-0
				---	***140L84-9					
DUR368A, DUR368L, UR002G, UR003G	M10x1.25LH	Ozubené 10T	25.4	---	***140L84-9	50	346084-7	68	168526-9	264025-0
DUR369A, DUR369L, UR101C, UR201C	M10x1.25LH	Ozubené 10T	25.4	64.5	144312-2	43	347104-0	68	457274-8	252236-9
UR012G	M10x1.25LH	Ozubené 10T	25.4	70.5	140J59-6	54.5	162567-7	Integrované s podložkou na upínanie noža		252236-9
UR013G	M10x1.25LH	Ozubené 10T	25.4	64.5	140N88-3	43	347766-4	68	413201-5	252236-9
UR016G, UR017G	M10x1.25LH	Ozubené 10T	45041	50	140A87-7	43	347766-4	68	413201-5	252236-9

Delený krovinorez

EM402MP	M10x1.25LH	Ozubené 10T	25.4	60	326821-5	50	346084-7	68	168526-9	264025-0
EM401MP	M10x1.25LH	Ozubené 10T	25.4	60	331861-0 326821-5	50	346084-7	68	168526-9	264025-0
EM403MP, EM404MP	M10x1.25LH	Ozubené 10T	25.4	64.5	144312-2	43	347105-8	68	457290-0	252236-9
EM405MP, EM406MP	M10x1.25LH	Ozubené 10T	-	64.5	144312-2	-	-	-	-	252236-9
EM408MP	M10x1.25LH	Ozubené 10T	25.4	64.5	140N88-3	43	347766-4	68	413201-5	252236-9
EM409MP	M10x1.25LH	Ozubené 10T	-	64.5	140N88-3	-	-	-	-	252236-9

Akumulátorový vyžíňač











Model	Veľkosť vretena	Podložka		Podložka s ochranou proti namotaniu trávy
		Priemer (mm)	Obj. č.	
DUR184L	M8x1.25RH	36.5	326683-1 144512-4	346857-8
DUR187L, DUR187U, DUR188L, DUR188U	M8x1.25LH	36.5	144512-4	346857-8
DUR189	M8x1.25RH	36.5	144512-4	346857-8
DUR192L	M10x1.25LH	71	140W47-1	

Akumulátorový vyžíňač DUR190L / U, DUR191L / U	191W97-9	6,49 € (MOC s DPH)
Sada na použitie žacieho noža.		
347668-4	podložka	
168526-9	miska noža	
264025-0	matica noža	
	kryt noža	



PRÍSLUŠENSTVO PRE ZÁHRADU





Odporúčané použitie

Typ			
	Malá a riedka tráva	Vysoká a hustá tráva	Zarastené porasty s drevenými kŕikmi
Nylónová hlava		←————→	
Plastový nôž		←————→	
Kovový nôž		←————→	
		←————→	
		←————→	
Žací nôž		←————→	
Mulčovací nôž		←————→	
Pílový kotúč		←————→	
Žací nôž		←————→	
T.C.T pílový kotúč		←————→	



Nože pre krovinořezy

Vŕtanie nožov: 25,4 mm



	Priemer / počet zubov	Hrúbka noža	Vhodné pre modely	Obj. č.	MOC s DPH
2-zubý nôž 	230mm / 2	2.0mm	DUR369A, DUR369L, UR006G, UR007G, UR101C, UR201C, EM400MP, EM401MP, EM402MP, EM403MP, EM404MP, UR016G, UR017G	*197808-2	8,89 €
	255mm / 2	2.0mm	DUR369A, DUR369L, UR006G, UR007G, UR101C, UR201C	**D-66064	5,29 €
	305mm / 2	2.0mm	UR012G	195624-6	cena na vyžiadanie
4-zubý nôž 	230mm / 4	1.8mm	DUR368A, DUR368L, DUR369A, DUR369L, UR002G, UR003G, UR006G, UR007G, UR016G, UR017G, UR101C, UR201C, EM400MP, EM401MP, EM402MP, EM403MP, EM404MP	**D-66008	6,89 €
	255mm / 4	2.0mm	DUR369A, DUR369L, EM3400U/L, UR006G, UR007G, UR016G, UR017G, UR101C, UR201C	729023-6	8,19 €
	255mm / 4	2.0mm	DUR369A, DUR369L, UR006G, UR007G, UR101C, UR201C	**D-66014	cena na vyžiadanie
8-zubý nôž 	200mm / 8	1.4mm	DUR194	191Y44-2	7,69 €
3-zubý nôž 	255mm / 3	3.0mm	UR006G, UR007G, UR101C, UR201C	385224340	15,59 €
	305mm / 3	3.0mm	UR012G	385224150	18,19 €

Špeciálne nože ochranné kryty



Na hustú trávnu, tenké drevené výhonky. Nie je k dispozícii v niektorých krajinách kvôli miestnym predpisom

Vhodné pre model	Nôž						Ochranný kryt				
	Priemer		Vŕtanie noža	Hrúbka noža	Obj. č.	MOC s DPH		Popis	Priemer rúry	Obj. č.	MOC s DPH
UR012G UR013G	225mm		25.4mm	1.8mm	199872-9	17,49 €		Bez ochrannej svorky	28mm	199873-7	17,59 €

Mulčovací nôž

Vhodné pre model	Nôž						Ochranný kryt				
	Priemer		Vŕtanie noža	Hrúbka noža	Obj. č.	MOC s DPH		Popis	Priemer rúry	Obj. č.	MOC s DPH
UR012G UR013G	270mm		25.4mm	3.9mm	199874-5	26,49 €		Bez ochrannej svorky	28mm	199875-3	30,22 €

Rotačné nožnice

Vhodné pre model	Nôž				Ochranný kryt					
	Priemer		Obj. č.	MOC s DPH		Popis	Priemer rúry	Obj. č.	MOC s DPH	
EM407MP	230mm		A: SY00146013 B: SY00146014	31,40 € 28,56 €		Bez ochrannej svorky	24mm	412999-1	8,58 €	

Nylónové žacie hlavy

Žacie hlavy s rýchlym navíjaním lanka

(UN-74L, UN-72L, 96-M8L/R, 96-M10L, 121-M10L)

Žacie lanko sa navíja bez rozobratia žacej hlavy

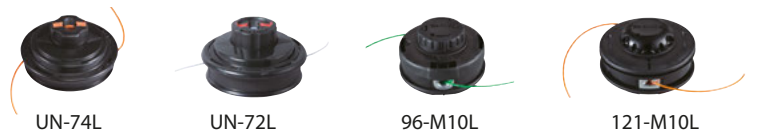

0 85(sec.)



0 35(sec.)



**Až o 58 %
kratší čas
doplnenia!**

Nylónové žacie hlavy



* s adaptérom

Očko 2ks/sada pre Push & Go 4L/4R/Z5L, Ultra Auto 4R/4L/6L obj. č. A-15992











Popis	Typ hlavy	Veľkosť	Závit vretena	Vhodné pre modely	Veľkosť lanka	Typ lanka	Obj. č.	MOC s DPH
Žacia hlava s rýchlym navíjaním lanka Push & Go 	96-M8R	4"	M8x1.25RH	DUR189	2.0mm x 4m	štvorlistok	191D92-5	13,09 €
	96-M8L	4"	M8x1.25LH	DUR187L	2.0mm x 4m	štvorlistok	191D91-7	12,09 €
	96-M10L	4"	M10x1.25LH	DUR190L, DUR190U, DUR191L, DUR191U, DUR192L, DUR368A, DUR368L, DUR369A, DUR369L, DUR369N, UR002G, UR003G, UR006G, UR007G, UR101C, UR201C, UR202C, UR016G, UR017G, EM400MP, EM401MP, EM403MP, EM404MP, EM405MP, EM406MP, EM408MP, EM409MP	2.0mm x 4m	štvorlistok	191D89-4	cena na vyžiadanie
					2.4mm x 3m	štvorlistok	191D90-9	11,69 €
	121-M10L	5"	M10x1.25LH	UR012G	2.4mm x 4m	štvorlistok	191D93-3	19,09 €
	121-M10L	5"	M10x1.25LH	UR013G	2.7mm x 2m	štvorlistok	1911Y2-9	13,09 €
Push & Go 	76-M8R	3"	M8x1.25RH	UR100D	1.65mm x 8m	štvorlistok	198854-8	21,29 €
	95-M8R	4"	M8x1.25RH	DUR189	2.0mm x 3m	štvorlistok	198971-4	15,99 €
	95-M8L	4"	M8x1.25LH	DUR187U/L, DUR188U/L, EM2500U/L, EM2600U/L	2.0mm x 3m	štvorlistok	198385-7	12,99 €
	95-M10L	4"	M10x1.25LH	DUR190L, DUR190U, DUR191L, DUR191U, DUR192L, DUR365U, DUR366L, DUR368A, DUR368L, DUR369A, DUR369L, DUR369N, UR002G, UR003G, UR006G, UR007G, UR101C, UR201C, UR202C, UR016G, UR017G, EM400MP, EM401MP, EM403MP, EM404MP, EM405MP, EM406MP, EM408MP, EM409MP	2.0mm x 3m	štvorlistok	198893-8	14,39 €
					2.4mm x 3m	štvorlistok	123556-7	11,60 €
Push & Go 	Bump & Feed ECO 4L	4" Low profile	M10x1.25LH	DUR192L, DUR368A, DUR368L, DUR369A, DUR369L, DUR369N, UR002G, UR003G, UR006G, UR007G, UR101C, UR201C, UR202C, UR016G, UR017G, EM408MP, EM409MP	2.0mm x 3m	štvorlistok	197296-3	15,39 €
Automatické podávanie a Push & Go 	Ultra Auto 4L	4"	M8&10x1.25LH	DUR187U/L, DU188U/L, EM400MP, EM401MP, EM403MP, EM404MP, EM405MP, EM406MP	2.4mm x 3m	okruhlé	*B-02945	22,49 €

Lanko vysúva približne o 3 cm na obidve strany
 – rotácia hlavy dosiahne otáčky 8 500 min⁻¹
 – klepnuť hlavu o zem keď je v otáčkach, lanko sa automaticky vysunie

Rada nylónov

Tvar	Ostrosť hrany	Úspora	Hlučnosť
Okruhlé 		A	A
Hranaté 	AA		
Štvorlístok 	A	AA	AA

Farebné rozlíšenie

Priemer	Farba / tvar	Lahká práca		Ťažká práca	
		Riedka tráva	Hustá tráva	Riedka tráva	Hustá tráva
1.3mm		↔			
1.6mm - 1.65mm	 	↔			
2.0mm	 		↔		
2.4mm	  		↔		
2.7mm				↔	
3.0mm	 			↔	

Štandardné nylónové lanko

Farba / tvar		Priemer (mm)	Dĺžka (m)	Obj. č.	MOC s DPH	MOC za 1 m s DPH
	Single	1.3	15	E-02727	1,79 €	0,12 €
	Single	1.6	15	E-02733	1,99 €	0,13 €
	Single	2.0	15	E-02705	2,09 €	0,14 €
	Single	2.0	126	E-02711	9,59 €	0,80 €
	Single	2.4	15	E-02749	2,89 €	0,19 €
	Single	2.4	87	E-02761	10,29 €	0,12 €
	Single	2.4	262	E-02783	25,99 €	0,10 €
	Single	3.0	15	369224809	2,89 €	0,19 €
	Single	3.0	56	369224811	8,69 €	0,16 €
	Single	3.0	168	369224815	24,39 €	0,15 €
	Single	3.3	15	369224810	3,09 €	0,21 €
	Single	3.3	46	369224812	8,79 €	0,19 €
	Single	2.4	15	E-02808	2,89 €	0,19 €
	Single	2.4	69	E-02814	9,59 €	0,14 €
	Single	2.4	206	E-02820	25,99 €	0,13 €
	Single	3.0	15	369224819	3,59 €	0,24 €
	Single	3.0	44	369224821	8,79 €	0,20 €
	Single	3.0	132	369224825	24,89 €	0,19 €
	Single	4.0	25	369224824	8,29 €	0,33 €

Nylónové lanko štvorhran točený

Farba / tvar		Priemer (mm)	Dĺžka (m)	Obj. č.	MOC s DPH	MOC za 1 m s DPH
	Single	2.0	15	369224060	3,89 €	0,26 €
	Single	2.0	120	369224062	18,89 €	0,16 €
	Single	2.4	120	369224072	21,79 €	0,18 €
	Single	2.7	90	369224063	21,79 €	0,24 €
	Single	2.7	15	369224673	4,99 €	0,33 €
	Single	3.0	15	369224674	5,59 €	0,37 €

Nylónové lanko v tvare štvorlístka

Farba / tvar		Priemer (mm)	Dĺžka (m)	Obj. č.	MOC s DPH	MOC za 1 m s DPH
	Single	1.65	15	E-01731	2,39 €	0,16 €
	Single	1.65	30	E-01747	4,29 €	0,14 €
	Single	1.65	445	E-01753	31,69 €	0,70 €
	Single	2.0	15	E-01769	2,69 €	0,18 €
	Single	2.0	30	E-01775	4,79 €	0,16 €
	Single	2.0	310	E-01781	31,69 €	0,10 €
	Single	2.4	15	E-01797	3,29 €	0,22 €
	Single	2.4	30	E-01806	5,89 €	0,20 €
	Single	2.4	225	E-01812	31,69 €	0,14 €
	Single	2.7	15	E-01828	3,39 €	0,23 €
	Single	2.7	30	E-01834	6,59 €	0,22 €
	Single	2.7	180	E-01840	31,69 €	0,18 €

Dvojité nylónové lanko

Increased durability up to 130%* thanks to Flexible core coated with Impact & abrasion resistant skin
*compared to standard nylon cord



Farba / tvar		Priemer (mm)	Dĺžka (m)	Obj. č.	MOC s DPH	MOC za 1 m s DPH
	Single	3.0	15	E-02836	4,09 €	0,27 €
	Single	3.0	56	E-02842	11,89 €	0,21 €
	Single	3.0	168	E-02858	29,69 €	0,18 €
	Single	3.0	279	E-02864	47,39 €	0,17 €
	Single	3.0	15	E-02870	4,39 €	0,29 €
	Single	3.0	44	E-02886	11,09 €	0,25 €
	Single	3.0	132	E-02892	29,69 €	0,20 €
	Single	3.0	219	E-02901	47,39 €	0,22 €

PRÍSLUŠENSTVO PRE ZÁHRADU

Model	Vhodný pre model	Obj. č.	MOC s DPH
-------	------------------	---------	-----------

Popruhy

Popruh pre PDC01 a PDC1200

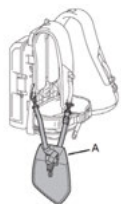

Model	Obj. č.	MOC bez DPH
A	191E43-4	22,88 €



Jednoramenný	DUA250, DUA251, DUA300, DUA301, DUN500W, DUN501W, DUR181, DUR184L, DUR187L, DUR188L, DUR189, DUR190L, DUR191L, DUR192L, DUR194, DUR368A, DUR368L, DUR369A, DUR369L, UA001G, UA002G, UA003G, UA004G; UR100D, DUX60	125516-5	3,29 €
Jednoramenný	DUR190L, DUR190U, DUR191U, DUR369A, DUR369L, UR006G, UR007G	125520-4	3,39 €
Dvojramenný	DUR369A, UR002G, UR006G, UR007G	122906-3	18,39 €
Dvojramenný	DUR369A, UR006G, UR007G	*199378-7	cena na vyžiadanie
	DUR368U, DUR369U, UR006G, UR012D	122A37-4	cena na vyžiadanie

Žacie hlavy pre vyžinače

















Vhodné pre model	Priemer/dĺžka	Tvar lanka	Obj. č.	MOC bez DPH
DUR180, DUR181	1.65mmx8m	okruhlé	195858-1	5,09 €
DUR193D	1.65mmx8m	štvorlístok	191Y39-5	8,49 €

Žací nôž plastový



Vhodné pre model	Žací nôž plastový				Náhradné čepele		
	Závit vretena	Šírka záberu	Obj. č.	MOC bez DPH	ks/bal.	Obj. č.	MOC bez DPH
UR100D	M8x1.25RH	230mm	198848-3	16,79 €	5	198851-4	3,99 €
DUR187L, DUR187U, DUR188L, DUR190L, DUR190U, DUR191L, DUR191U, DUR188U, DUR189, DUR364L, DUR366L, DUR368A, DUR368L, DUR369A, DUR369L, DUR369N, UR001G, UR002G, UR003G, UR006G, UR007G, UR008G, UR016G, UR017G, UR101C, UR201C, UR202C, EM403MP, EM404MP, EM405MP, EM406MP	M8x1.25RH M8x1.25LH M10x1.25LH	255mm	198383-1	19,49 €	12	198426-9	8,49 €
DUR369A, DUR369L, DUR369N, UR101C, UR201C, UR202C, UR012G, UR013G	M10x1.25LH	305mm	199868-0	23,59 €	12	199870-3	cena na vyžiadanie

PRÍSLUŠENSTVO PRE ZÁHRADU

Model	Popis	Vhodný pre model	Obj. č.	MOC s DPH	
Nadstavce pre delené krovinořezy					
	EM400MP	Krovinořez Šírka záberu: 300 mm (žacia hlava) 230 mm (žací nož kov, vrtanie 25,4 mm) závit vretena: M10 x 1.25 LH	DUX60, UX01G	195650-5	83,99 €
	EM404MP	Krovinořez Šírka záberu: 300 mm (žacia hlava) 230 mm (žací nož kov, vrtanie 25,4 mm) závit vretena: M10 x 1.25 LH	DUX60, UX01G	126603-3	86,99 €
	EM407MP	Rotačné nožnice Šírka záberu: 230 mm	DUX18, DUX60, UX01G	191M56-3	485,99 €
	EM408MP	Krovinořez Šírka záberu: 300 mm (žacia hlava) 230 mm (žací nož kov, vrtanie 25,4 mm) závit vretena: M10 x 1.25 LH	DUX18, DUX60, UX01G	191N31-5	87,39 €
	UB400MP	Fukár	DUX18, DUX60, UX01G	191F65-0	135,39 €
	UB401MP	Fukár	DUX18, DUX60, UX01G	191P72-3	224,29 €
	EY403MP	Vyvetvovacia píla dĺžka lišty: 30 cm	DUX18, DUX60, UX01G	191T38-7	135,79 €
	EN400MP	Nožnice na živé ploty s nastavením uhla	DUX18, DUX60, UX01G	196257-0	300,49 €
	EN420MP	Nožnice na trávnu s nastavením uhla	DUX18, DUX60, UX01G	198054-0	cena na vyžiadanie
	EN402MP	nožnice na živé ploty s nastavením uhla	DUX18, DUX60, UX01G	1912T8-8	170,69 €
	EN424MP	nožnice lištové na trávnu	DUX18, DUX60, UX01G	1913C9-3	183,59 €
	EE400MP	orezávač trávnik	DUX18, DUX60, UX01G	196752-0	161,59 €
	PF400MP	vodná pumpa na čistú vodu	DUX18, DUX60, UX01G	DEAPF400MP	184,49 €
	KR400MP	Kultivátor Šírka: 160 mm	DUX18, DUX60, UX01G	195709-8	110,09 €
	BR400MP	Nylónová kefa	DUX18, DUX60, UX01G	199317-7	338,49 €
	SW400MP	Gumená kefa	DUX18, DUX60, UX01G	199338-9	379,29 €
	LE400MP	Predĺženie 1 m	DUX18, DUX60, UX01G	191E24-8	72,09 €

Akumulátory
Odkladacie systémy
Vrtanie
Skrutkovanie
Brúsky
Pílenie
Frézovanie
Brúsenie
Klince / spony
Špeciálne stroje
Vysávanie
Fény/lampy
Záhrada
Ručné náradie
Ostatné

Pílové reťaze a lišty

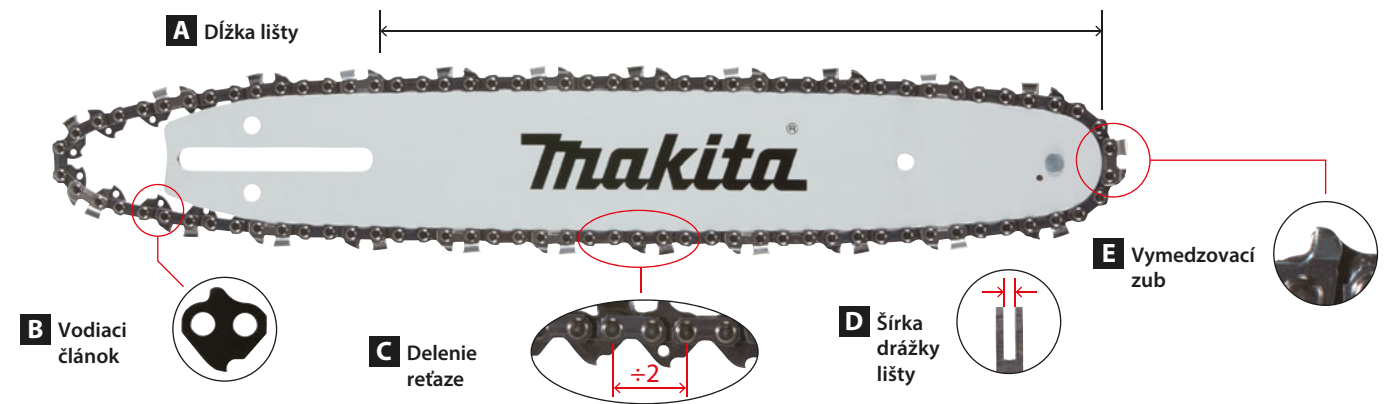

A Dĺžka lišty

Dĺžka lišty udáva priemer rezu, je olišná od celkovej dĺžky



B Vodiaci článok

Dĺžka pílovej reťaze sa určuje počtom vodiacich článkov

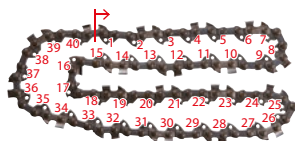

C Delenie reťaze

Delenie reťaze je definované vzdialenou medzi akýmikoľvek tromi po sebe idúcimi nitmy delené dvoma. Delenie je dôležité, pretože hnacie ozubené koleso musí mať rovnaký delenie ako reťaz.



D Šírka drážky lišty

Šírku drážky určuje šírka vodiaceho článku, je potrebné používať lištu aj reťaz s rovnakou šírkou.

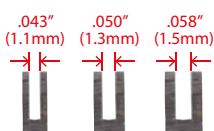

E Vymedzovací zub

Vymedzovací zub určuje záber pílového zubu do dreva.



Charakteristika pílových reťazí

D Šírka drážky lišty	C Delenie reťaze	Rýchlosť rezu			
		Rýchle	← Rýchlosť rezu →	Pomalé	
0.043" (1.1mm)					
0.050" (1.3mm)					
0.058" (1.5mm)					
0.063" (1.6mm)					
	1/4"	25AP 25F			
	.325"LP	80			
	3/8"LP	90PX	91PX 91F 91VXL		
	.325"		20BPX 95VPX	21BPX 21LPX	22BPX 22LPX
	3/8"		72LPX 72V	73DPX 73LGX 73LPX	75LPX 75LPX
	.404"				27X 59AC

Typy lišt

Lišta s ozubeným kolesom

Ozubené koleso na špičke lišty zabezpečuje pohyb reťaze s menším trením.



Lišty bez ozubeného kolesa

Špička lišty spevnená stelitom (zliatina kobaltu a chrómu), určená pre obzvlášť náročné práce s drevom v lesoch po požiaroch a vo veľmi prašnom prostredí



Carvingová lišta

Lišty vyrobené z vysoko kvalitnej ocele a stelitom, sú vysoko odolné voči opotrebovaniu. Špička lišty má malý priemer pre presné rezanie. Určené pre vyrezávanie a orezávanie presných tvarov.



Starostlivosť o lištu

Napnutie reťaze

Pred použitím skontrolujte napnutie reťaze.



Okraj lišty

Udržiavajte v 90° uhle pomocou plochého pilníka.



Čistenie lišty

Čistite lištu pravidelne pri ostrení alebo výmene reťaze.



Ozubené koleso lišty

Pravidelne premažte ozubené kolesolišty, pre bezproblémový chod reťaze.

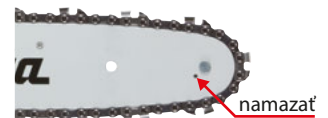

Ostrenie pílovej reťaze

Okruhly pilník s držiakom

Lepšie ostrenie reťaze vďaka pevnému uchytieniu pilníka v držiaku. Držiak má vyznačené presné uhly ostrenia reťaze (30°) a zabraňuje podbrúseniu reťaze.

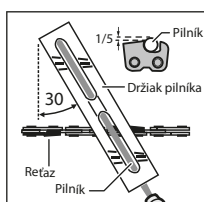
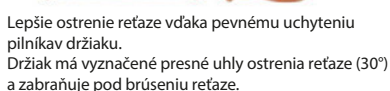

Mierka reťaze

Pomocou mierky reťaze kontrolujete výšku vymedzovacieho zubu a plochým pilníkom ho zbrúsite na požadovanú veľkosť.

Plochý pilník

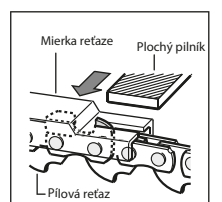
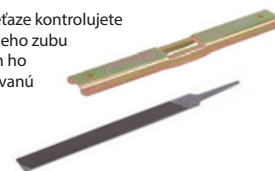

Reťazové píly

Lišty / pilové reťaze / kryty lišt / záberové koleso

Typ zubov: CC: dlátovitý, SC: polodlátovitý, MC: Mikro zub



Vhodné pre model	Lišta					Pilové reťaze						Kryt lišty		Záberové koleso		
	Dĺžka lišty	Typ lišty	Obj. č.	MOC s DPH	Počet vodičoch článkov	Šírka drážky lišty	Delenie reťaze	Typ reťaze	Typ zubov	Obj. č.	MOC s DPH	Obj. č.	MOC s DPH	Typ/delenie	Obj. č.	MOC s DPH

Vyvetvovacie píly

*EY401MP	25cm/10"	S ozubeným kolesom	191G11-9	cena na vyžiadanie	39	1.3mm/.050"	3/8" LP	91VXL	SC	191H20-4	cena na vyžiadanie	458501-6	3,49 €	Sprocket 3/8"LP	XTM0000014	12,73 €
*EY402MP *EY403MP DUA250 DUA251 DUA300 DUA301 UA001	25cm/10" 30cm/12" 25cm/10" 30cm/12"	S ozubeným kolesom	191G14-3 191G15-1 191G22-4 191G23-2	11,99 € 12,39 € 11,89 € 11,79 €	40 46 40 46	1.1mm/.043" 1.3mm/.050"	3/8" LP	90PX 91PX	CC CC	191H00-0 191H01-8 191H08-4 191H10-7	8,79 € 14,79 € 12,89 € 12,99 €	458501-6 419288-5 458501-6 419288-5	3,49 € 2,39 € 3,49 € 2,39 €	Sprocket 3/8"LP	226992-7	3,34 €

Akumulátorové reťazové píly

DUC101 UC100D	10cm/4"	Bez ozubeného kolesa	1910W0-3	14,49 €	26	1.1mm/.043"	.325" LP	80TXL	MC	1910V6-4	10,59 €	413M40-1	cena na vyžiadanie	.325"LP	227947-5	cena na vyžiadanie
DUC121, DUC122	16cm/ 6-1/4"	Bez ozubeného kolesa	158476-6	18,89 €	42	1.3mm/.050"	1/4"	25AP	MC	191G95-7	15,09 €	416311-7	2,59 €	Sprocket 1/4"	221527-9	2,04 €
DUC204 DUC254 DUC254C	25cm/10"	Carvingová lišta	1911A1-3	cena na vyžiadanie	60	1.3mm/.050"	1/4"	25AP	MC	191G96-5	20,19 €	458501-6	3,49 €	Sprocket 1/4"	198259-2	3,19 €
	25cm/10"	S ozubeným kolesom	191T85-8	12,09 €	46	1.1mm/.043"	3/8" LP	80TXL	MC	191T89-0	17,39 €	458501-6	3,49 €			
	30cm/12"	S ozubeným kolesom	191T86-6	12,39 €	51	1.1mm/.043"	3/8" LP	80TXL	MC	191T90-5	21,49 €	419288-5	2,39 €	.325"LP	1911W6-9	cena na vyžiadanie
	25cm/10"	S ozubeným kolesom	191G14-3	11,99 €	40	1.1mm/.043"	3/8" LP	90PX	CC	191H00-0	8,79 €	458501-6	3,49 €			
	30cm/12"	S ozubeným kolesom	191G15-1	12,39 €	46	1.1mm/.043"	3/8" LP	90PX	CC	191H01-8	14,79 €	419288-5	2,39 €	Sprocket 3/8"LP	199063-2	2,12 €
DUC252 DUC302 DUC352 DUC252C	25cm/10"	Carvingová lišta	1911A1-3	cena na vyžiadanie	60	1.3mm/.050"	1/4"	25AP	MC	191G96-5	20,19 €	458501-6	3,49 €	Sprocket 1/4"	221528-7	6,85 €
	25cm/10"	S ozubeným kolesom	191G14-3	11,99 €	40	1.1mm/.043"	3/8" LP	90PX	CC	191H00-0	8,79 €	458501-6	3,49 €			
	30cm/12"	S ozubeným kolesom	191G15-1	12,39 €	46	1.1mm/.043"	3/8" LP	90PX	CC	191H01-8	14,79 €	419288-5	2,39 €			
	35cm/14"	S ozubeným kolesom	191G16-9	13,19 €	52	1.1mm/.043"	3/8" LP	90PX	CC	191H02-6	13,99 €	419288-5	2,39 €	Sprocket 3/8"LP	221526-1	0,89 €
	25cm/10"	S ozubeným kolesom	191G22-4	11,89 €	40	1.3mm/.050"	3/8" LP	91PX	CC	191H08-4	12,89 €	458501-6	3,49 €			
DUC256 DUC306 DUC356 DUC406 DUC256C	25cm/10"	Carvingová lišta	1911A1-3	cena na vyžiadanie	60	1.3mm/.050"	1/4"	25AP	MC	191G96-5	20,19 €	458501-6	3,49 €	Sprocket 1/4"	198259-2	3,19 €
	25cm/10"	S ozubeným kolesom	191T85-8	12,09 €	46	1.1mm/.043"	.325" LP	80TXL	MC	191T89-0	17,39 €	458501-6	3,49 €			
	30cm/12"	S ozubeným kolesom	191T86-6	12,39 €	51	1.1mm/.043"	.325" LP	80TXL	MC	191T90-5	21,49 €	419288-5	2,39 €	Sprocket .325"LP	199063-2	2,12 €
	35cm/14"	S ozubeným kolesom	191T87-4	15,49 €	59	1.1mm/.043"	.325" LP	80TXL	MC	191T91-3	23,09 €	419288-5	2,39 €			
	25cm/10"	S ozubeným kolesom	191G14-3	11,99 €	40	1.1mm/.043"	3/8" LP	90PX	CC	191H00-0	8,79 €	458501-6	3,49 €			
	30cm/12"	S ozubeným kolesom	191G15-1	12,39 €	46	1.1mm/.043"	3/8" LP	90PX	CC	191H01-8	14,79 €	419288-5	2,39 €			
	35cm/14"	S ozubeným kolesom	191G16-9	13,19 €	52	1.1mm/.043"	3/8" LP	90PX	CC	191H02-6	13,99 €	419288-5	2,39 €			
	40cm/16"	S ozubeným kolesom	191G17-7	13,79 €	56	1.1mm/.043"	3/8" LP	90PX	CC	191H03-4	16,69 €	419242-9	3,49 €	Sprocket 3/8"LP	199063-2	2,12 €
	25cm/10"	S ozubeným kolesom	191G22-4	11,89 €	40	1.3mm/.050"	3/8" LP	91PX	CC	191H08-4	12,89 €	458501-6	3,49 €			
	30cm/12"	S ozubeným kolesom	191G23-2	11,79 €	46	1.3mm/.050"	3/8" LP	91PX	CC	191H10-7	12,99 €	419288-5	2,39 €			
35cm/14"	S ozubeným kolesom	191G24-0	12,79 €	52	1.3mm/.050"	3/8" LP	91PX	CC	191H11-5	12,69 €	419288-5	2,39 €				
DUC307 DUC357 DUC407	30cm/12"	S ozubeným kolesom	191G15-1	12,39 €	46	1.1mm/.043"	3/8" LP	90TXL	CC	191H01-8	14,79 €	419288-5	2,39 €			
	35cm/14"	S ozubeným kolesom	191G16-9	13,19 €	52	1.1mm/.043"	3/8" LP	90TXL	CC	191H02-6	13,99 €	419288-5	2,39 €			
	40cm/16"	S ozubeným kolesom	191G17-7	13,79 €	56	1.1mm/.043"	3/8" LP	90TXL	CC	191H03-4	16,69 €	419242-9	3,49 €	Sprocket 3/8"LP	199063-2	2,12 €
	30cm/12"	S ozubeným kolesom	191G23-2	11,79 €	46	1.3mm/.050"	3/8" LP	91PX	CC	191H10-7	12,99 €	419288-5	2,39 €			
	35cm/14"	S ozubeným kolesom	191G24-0	12,79 €	52	1.3mm/.050"	3/8" LP	91PX	CC	191H11-5	12,69 €	419288-5	2,39 €			
DUC256 DUC306 DUC356 DUC406 DUC256C	25cm/10"	Carvingová lišta	1911A1-3	cena na vyžiadanie	60	1.3mm/.050"	1/4"	25AP	MC	191G96-5	20,19 €	458501-6	3,49 €	Sprocket 1/4"	198259-2	3,19 €
	30cm/12"	S ozubeným kolesom	191T86-6	12,39 €	51	1.1mm/.043"	.325" LP	80TXL	MC	191T90-5	21,49 €	419288-5	2,39 €	Sprocket .325"LP	1911W6-9	cena na vyžiadanie
	35cm/14"	S ozubeným kolesom	191T87-4	15,49 €	59	1.1mm/.043"	.325" LP	80TXL	MC	191T91-3	23,09 €	419288-5	2,39 €			
	40cm/16"	S ozubeným kolesom	191T88-2	17,39 €	64	1.1mm/.043"	.325" LP	80TXL	MC	191T92-1	25,39 €	419242-9	3,49 €			
	30cm/12"	S ozubeným kolesom	191G15-1	12,39 €	46	1.1mm/.043"	3/8" LP	90PX	CC	191H01-8	14,79 €	419288-5	2,39 €			
	35cm/14"	S ozubeným kolesom	191G16-9	13,19 €	52	1.1mm/.043"	3/8" LP	90PX	CC	191H02-6	13,99 €	419288-5	2,39 €			
	40cm/16"	S ozubeným kolesom	191G17-7	13,79 €	56	1.1mm/.043"	3/8" LP	90PX	CC	191H03-4	16,69 €	419242-9	3,49 €	Sprocket 3/8"LP	199063-2	2,12 €
	30cm/12"	S ozubeným kolesom	191G23-2	11,79 €	46	1.3mm/.050"	3/8" LP	91PX	CC	191H10-7	12,99 €	419288-5	2,39 €			
	35cm/14"	S ozubeným kolesom	191G24-0	12,79 €	52	1.3mm/.050"	3/8" LP	91PX	CC	191H11-5	12,69 €	419288-5	2,39 €			
	40cm/16"	S ozubeným kolesom	191G25-8	13,99 €	56	1.3mm/.050"	3/8" LP	91PX	CC	191H12-3	13,79 €	419242-9	3,49 €			

Akumulátory

Odkladacie systémy

Vŕtanie

Skrutkovanie

Brúsky

Pílenie

Frézovanie

Brúsenie

Klince / spony

Špeciálne stroje

Vysávanie

Fény/lampy

Záhrada

Ručné náradie

Ostatné

Vhodné pre model	Lišta				Pilové reťaze							Kryt lišty		Záberové koleso		
	Dĺžka lišty	Typ lišty	Obj. č.	MOC s DPH	Počet vodiacich článkov	Šírka drážky lišty	Delenie reťaze	Typ reťaze	Typ zubov	Obj. č.	MOC s DPH	Obj. č.	MOC s DPH	Typ/delenie	Obj. č.	MOC s DPH
UC002G UC003G UC004G UC006G UC007G	25cm/10"	Carvingová lišta	1911A1-3	cena na vyžiadanie	60	1.3mm/.050"	1/4"	25AP	MC	191G96-5	20,19 €	458501-6	3,49 €	Sprocket 1/4"	191V92-3	9,29 €
	25cm/10"		191T86-6	12,39 €	46					191T89-0	17,39 €	458501-6	3,49 €			
	30cm/12"	S ozubeným kolesom	191T86-6	12,39 €	51	1.1mm/.043"	.325" LP	80PX	MC	191T90-5	21,49 €	419288-5	2,39 €	Sprocket .325" LP	191V91-5	9,41 €
	35cm/14"		191T87-4	15,49 €	59					191T91-3	23,09 €	419288-5	2,39 €			
	25cm/10"		191G14-3	11,99 €	40					191H00-0	8,79 €	458501-6	3,49 €			
	30cm/12"	S ozubeným kolesom	191G15-1	12,39 €	46	1.1mm/.043"	3/8" LP	90PX	CC	191H01-8	14,79 €	419288-5	2,39 €			
	35cm/14"		191G16-9	13,19 €	52					191H02-6	13,99 €	419288-5	2,39 €			
	25cm/10"		191G22-4	11,89 €	40					191H08-4	12,89 €	458501-6	3,49 €			
	30cm/12"	S ozubeným kolesom	191G23-2	11,79 €	46	1.3mm/.050"	3/8" LP	91PX	CC	191H10-7	12,99 €	419288-5	2,39 €			
	35cm/14"		191G24-0	12,79 €	52					191H11-5	12,69 €	419288-5	2,39 €			
UC010G UC011G UC012G UC013G UC014G UC015G UC016G UC017G UC020G	30cm/12"		191T86-6	12,39 €	51					191T90-5	21,49 €	419288-5	2,39 €			
	35cm/14"	S ozubeným kolesom	191T87-4	15,49 €	59	1.1mm/.043"	.325" LP	80TXL	MC	191T91-3	23,09 €	419288-5	2,39 €	Sprocket .325" LP	191V91-5	9,41 €
	40cm/16"		191T88-2	17,39 €	64					191T92-1	25,39 €	419242-9	3,49 €			
	45cm/18"		191X03-0	19,89 €	70					191X04-8	26,59 €	419242-9	3,49 €			
	30cm/12"		191G15-1	12,39 €	46					191H01-8	14,79 €	419288-5	2,39 €			
	35cm/14"	S ozubeným kolesom	191G16-9	13,19 €	52	1.1mm/.043"	3/8" LP	90PX	CC	191H02-6	13,99 €	419288-5	2,39 €			
	40cm/16"		191G17-7	13,79 €	56					191H03-4	16,69 €	419242-9	3,49 €			
	30cm/12"		191G23-2	11,79 €	46					191H10-7	12,99 €	419288-5	2,39 €	Sprocket 3/8" LP	191V90-7	9,34 €
	35cm/14"	S ozubeným kolesom	191G24-0	12,79 €	52	1.3mm/.050"	3/8" LP	91PX	CC	191H11-5	12,69 €	419288-5	2,39 €			
	40cm/16"		191G25-8	13,99 €	56					191H12-3	13,79 €	419242-9	3,49 €			
45cm/18"		191G26-6	14,59 €	62					191H13-1	18,69 €	419242-9	3,49 €				

Elektrické reťazové píly

UC3041A, UC3541A, UC4041A	30cm/12"		191G15-1	12,39 €	46					191H01-8	14,79 €	419288-5	2,39 €			
	35cm/14"	S ozubeným kolesom	191G16-9	13,19 €	52	1.1mm/.043"	3/8"	90PX	CC	191H02-6	13,99 €	419288-5	2,39 €			
	40cm/16"		191G17-7	13,79 €	56					191H03-4	16,69 €	419242-9	3,49 €	Sprocket 3/8" LP	221526-1	0,89 €
	30cm/12"		191G23-2	11,79 €	46					191H10-7	12,99 €	419288-5	2,39 €			
	35cm/14"	S ozubeným kolesom	191G24-0	12,79 €	52	1.3mm/.050"	3/8"	91PX	CC	191H11-5	12,69 €	419288-5	2,39 €			
	40cm/16"		191G25-8	13,99 €	56					191H12-3	13,79 €	419242-9	3,49 €			
UC3050A, UC3550A, UC4050A, UC4550A, UC3051A, UC3551A, UC4051A, UC4551A	30cm/12"		191G23-2	11,79 €	46					191H10-7	12,99 €	419288-5	2,39 €			
	35cm/14"	S ozubeným kolesom	191G24-0	12,79 €	52	1.3mm/.050"	3/8"	91PX	CC	191H11-5	12,69 €	419288-5	2,39 €	Sprocket 3/8" LP	221521-1	cena na vyžiadanie
	40cm/16"		191G25-8	13,99 €	56					191H12-3	13,79 €	419242-9	3,49 €			
	45cm/18"		191G26-6	14,59 €	62					191H13-1	18,69 €	419242-9	3,49 €			

Karvingová lišta

250mm: Obj. č. 168395-8



Pilové reťaz 25AP-60 vodiacich článkov
Obj. č. 194098-8



Ozubené koleso 1/4"
DUC204, DUC254, DUC254C, DUC303, DUC353, DUC400, DUC305, DUC355, DUC405DUC256,
DUC306, DUC356, DUC406, DUC256C: Part No. 198259-2

DUC252, DUC302, DUC352, DUC252C: 221528-7

UC002G, UC003G, UC004G, UC006G, UC007G: 191V92-3



Uhlový prevod pre pilové nadstavce



Vhodné pre model	Obj. č.	MOC s DPH
UA001G, UA002G, UA003G, UA004G, DUA250, DUA251, DUA300, DUA301	1910J6-0	73,69 €

PRÍSLUŠENSTVO PRE ZÁHRADU

Vhodné pre model	Lišta					Pilové reťaze						
	Dĺžka lišty	Typ lišty	Počet zubov	Obj. č.	MOC s DPH	Počet vodiacich článkov	Šírka drážky lišty	Delenie reťaze	Typ reťaze	Typ zubov	Obj. č.	MOC s DPH

Pilové lišty a reťaze pre benzínové píly

PS-220 TH PS-221 TH	25 cm/10"	S ozubeným kolesom	7	191G22-4	11,89 €	40	1,3 mm/.050"	3/8"	91PX	CC	191H08-4	12,89 €		
PS32C/TLC PS-35 C/TLC PS-310 TH PS-3410TH PS-350 SC PS-352 / TLC	30 cm/12"	S ozubeným kolesom	7	191G23-2	11,79 €	46	1,3 mm/.050"	3/8"	91PX	CC	191H10-7	12,99 €		
	35 cm/14"		7	191G24-0	12,79 €	52	1,3 mm/.050"	3/8"	91PX	CC	191H11-5	12,69 €		
	40 cm/16"		7	191G25-8	13,99 €	56	1,3 mm/.050"	3/8"	91PX	CC	191H12-3	13,79 €		
PS-410, PS-411, PS-420 C PS-460 PS-500/C PS-550 PS-6100 PS-5105/C PS-4605	30 cm/13"	S ozubeným kolesom	7	191G38-9	16,29 €	56	1,3 mm/.050"	0.325"	95VPX	CC	191H22-0	15,49 €		
	38 cm/15"		7	191G33-9	cena na vyžiadanie	64	1,3 mm/.050"	0.325"	95VPX	CC	191H23-8	cena na vyžiadanie		
	45 cm/18"		7	191G34-7	cena na vyžiadanie	72	1,3 mm/.050"	0.325"	95VPX	CC	191H24-6	23,59 €		
	38 cm/15"		7	191G50-9	cena na vyžiadanie	56	1,5 mm/.058"	3/8"	73DPX	SC	191H42-4	17,29 €		
	45 cm/18"		7	191G51-7	cena na vyžiadanie	64	1,5 mm/.058"	3/8"	73DPX	SC	191H43-2	cena na vyžiadanie		
	38 cm/15"		7	191G45-2	32,79 €	64	1,5 mm/.058"	0.325"	21BPX	CC	191H35-1	18,49 €		
	45 cm/18"		7	191G46-0	31,39 €	72	1,5 mm/.058"	0.325"	21BPX	CC	191H36-9	22,09 €		
	38 cm/15"		7	191G50-9	cena na vyžiadanie	56	1,5 mm/.058"	3/8"	73LPX	CC	191H42-4	17,29 €		
	45 cm/18"		7	191G51-7	cena na vyžiadanie	64	1,5 mm/.058"	3/8"	73LPX	CC	191H50-5	cena na vyžiadanie		
						191G52-5	cena na vyžiadanie	72	1,5 mm/.058"	3/8"	73LPX	CC	191H52-1	22,39 €
	38 cm/15"		7	191G45-2	32,79 €	64	1,5 mm/.058"	0.325"	21LPX	CC	191H35-1	18,49 €		
	45 cm/18"		7	191G46-0	31,39 €	72	1,5 mm/.058"	0.325"	21LPX	CC	191H36-9	22,09 €		
	45 cm/18"		7	415045655	24,29 €	68	1,5 mm/.058"	3/8"	73LPX	CC	191H51-3	22,49 €		
50 cm/20"	7	415050655	26,49 €	72	1,5 mm/.058"	3/8"	73LPX	CC	191H52-1	22,39 €				

Rolky reťazi

	Delenie reťaze	Šírka drážky		Počet článkov na kotúči*	Profil zuby**	Obj. č.	MOC (s DPH)
	3/8"	1,1 mm	0,043"	1637	HM	957 291 801	346,79 €
	3/8"	1,5 mm	0,058"	1637	HM	957 093 801	395,19 €
	0,325"	1,3 mm	0,050"	1848	HM	957 484 801***	381,29 €
	0,325"	1,5 mm	0,058"	1848	VM	957 686 801	419,79 €

* +/- 5 článkov na 1 kotúč

** VM – hranatý profil zuby; HM – guľatý profil zuby

*** do vypredania zásob

PRÍSLUŠENSTVO PRE ZÁHRADU

Okrúhle pilníky

pre pilové reťaze
*s rukoväťou



Typ pilovej reťaze	Okrúhly pilník			Pilník s vodítkom		
	Priemer	Obj. č.	ks/bal	MOC s DPH	Obj. č.	MOC s DPH
25F, 25AP, 91P, 91PX, 91PXL, 91VXL, M91VXL	4.0mm	*744003-1	1	2,29 €	-	
		953003090	1	2,09 €	958500166 953030010	8,69 € 14,09 €
		958500162	3	3,89 €	D-70948	6,89 €
90PX, 90SG	4.5mm	953003100	1	2,29 €	195923-6 953030020	cena na vyžiadanie 13,99 €
		958500163	3	3,89 €	D-70954	7,39 €
95VPX, 95TXL, 20BPX, 21BPX, 22BPX, 20LPX, 21LPX, 22LPX, 082, 086, 686, 484	4.8mm	953003070	1	2,09 €	953030030	6,29 €
		958500164	3	3,89 €	D-70960	7,59 €
90PX, 90SG	5.2mm	953003110	1	2,09 €		
72V, 73V, 75V, 72APX, 72DPX, 73DPX, 75DPX, 72EXL, 73EXL, 75EXL, 72EXJ, 73EXJ, 75EXJ, 72LGX, 73LGX, 75LGX, 72JGX, 73JGX, 75JGX, 72JPX, 73JPX, 75JPX, 72LPX, 73LPX, 75LPX, 72RD, 73RD, 75RD, 496, 093, 099	5.5mm	953003040	1	2,09 €	958500169	8,59 €

* dodávané s rukoväťou

Plochy pilník, mierka reťaze

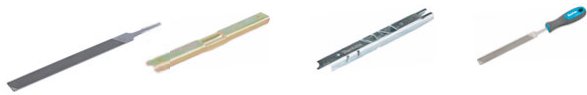

Plochy pilník			Mierka reťaze		Pilník plochy s držiakom	
Obj. č.	ks/bal	MOC s DPH	Obj. č.	MOC s DPH	Obj. č.	MOC s DPH
953003060	1	6,19 €	953100090	5,99 €	D-70998	5,39 €

Rukoväť pilníka



ks/bal	Obj. č.	MOC s DPH
1	273646-7	2,29 €
1	D-67496	1,69 €

Držiak káblov



Typ	Popis	Obj. č.	MOC s DPH
A	Držiak kábla na ruku	194679-8	3,68 €
B	Držiak kábla na opasok	194677-2	cena na vyžiadanie
C	Úchytka kábla spojovacia	158024-1	0,88 €

Olej na pilové reťaze

Popis	Obj. č.	MOC s DPH	MOC s DPH / 1l
Olej na pilové reťaze	1L 195093-1	5,39 €	5,39 €
Olej na pilové reťaze	5L 1910T9-4	24,99 €	5,00 €
BIOTOP Olej na pilové reťaze	1L 980008610	6,19 €	6,19 €

Olej pre dvojtaktné motory 50:1

Popis	Obj. č.	MOC s DPH	MOC s DPH / 1l
100 ml	195957-9	1,49 €	14,90 €
1 l	980008607	6,69 €	6,69 €
1 l s odmerkou	980008612	9,39 €	9,39 €
5l	980008618	33,19 €	6,63 €
200 l	980008151	1 285,99 €	6,43 €

Olej pre štvortaktné motorové kosačky a krovinnorezy HD-30

Popis	Obj. č.	MOC s DPH	MOC s DPH / 1l
100 ml	197010-7	4,99 €	49,90 €
600 ml	98008620	3,79 €	6,32 €

Čistiace a ochranné prostriedky

Popis	Obj. č.	MOC s DPH	MOC s DPH / 1l
Multifukčný olej	300 ml 980008301*	6,19 €	2,63 €
Prostriedok na čistenie pilových reťazí	500 ml 980008125	7,59 €	15,18 €
vazelína na mazanie nožnic polstrojov	80 ml 197439-7	6,49 €	81,13 €

*do vypredania zásob

Vysávačky, dávkovače oleja, kanistre

Popis	Obj. č.	MOC s DPH
Vysávačka / striekačka oleja	664718000	47,47 €
Dávkovač oleja - pumpa	242072-1	2,89 €
Kanister priehľadný 5 l	949000033	17,79 €
Kanister zelený 20 l	949000039	42,99 €

Predĺženie

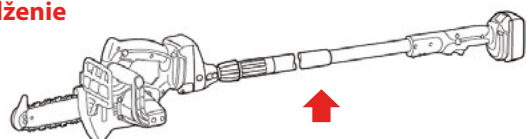

Vhodné pre model	Použitie len s akumulátorom	Obj. č.	MOC s DPH
DUC122	BL1830B	195595-7	184,19 €

Nožnice, kryty nožnic pre nožnice na trávnu



Vhodné pre model	Šírka strihu	1	2	3
		Nožnica	Kryt nožnice	Zberač trávy
DUM168, DUM604, UM600D, UM603D	160mm	195267-4	452055-5	457426-1
DUM111 UM110D	110mm	191N23-4	459011-6	454880-0

Zmena nožnic na trávnu na nožnice na kríky

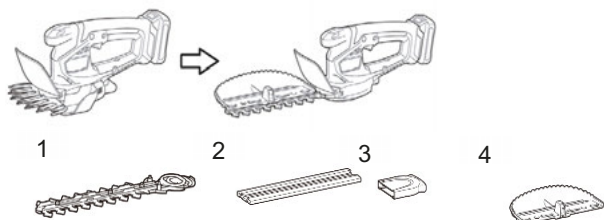

*With clank cover

Vhodné pre model	1		
	Nožnica	MOC s DPH	Povrchová úprava
DUM111 DUM110	191N24-2	14,79 €	BLACK OXIDE
DUM604, UM600D, UM603D	198408-1	16,09 €	NICKEL PLATING

Vhodné pre model	2		4	MOC s DPH
	Kryt nožnice	MOC s DPH	Zberač odrezkov	
DUM111 DUM110	458342-0	6,49 €	198401-5	8,99 €
	*195274-7	cena na vyžiadanie		
DUM604, UM600D, UM603D	458342-0	6,49 €	198401-5	8,99 €



Nožnice pre plotostrihy

Typ nožnice

A:

Optimálne pre hladké rezanie



Konáre sa ľahko zachytia a držia

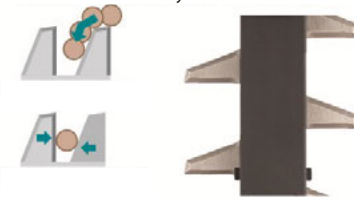

B: Nože s pevným úchopom

Horné / dolné zuby nožnice s nabrúsenými 3 hranami pre čistý a rýchly rez



C: Nože s poniklovanou povrchovou úpravou

Rovnomerne a silne prilievajúca povrchová úprava, ktorá sa vyznačuje vysokou odolnosťou proti oderu.

Živica na nožoch (po 10 hodinovej práci)



Vhodné pre model	Veľkosť noža	Typ noža	Nôž		Kryt noža	
			Obj. č.	MOC s DPH	Obj. č.	MOC s DPH

Akumulátorové nožnice na živý plot

UH201D DUH202	200mm	C	198408-1	16,09 €	458342-0	6,49 €
DUH551	550mm	C	196687-5	87,39 €	450489-6	cena na vyžiadanie
DUH651	650mm	C	194674-8	64,56 €	450490-1	cena na vyžiadanie
DUH523	520mm		195769-0	46,79 €	452685-2	cena na vyžiadanie
DUH601	600mm	A	191R53-9	89,59 €	412911-1	cena na vyžiadanie
DUH751	750mm	A	191R54-7	cena na vyžiadanie	412912-9	cena na vyžiadanie
DUH604S	600mm	A	191Y03-6	cena na vyžiadanie	459121-9	4,79 €
DUH754S	750mm	A	191Y05-2	cena na vyžiadanie	459122-7	cena na vyžiadanie
DUH502	500mm	B	191T47-6	cena na vyžiadanie	412768-0	cena na vyžiadanie
DUH602	600mm	B	191R57-1	cena na vyžiadanie	412769-8	cena na vyžiadanie
DUH507	500mm	A	1911J1-6	44,99 €	413L91-8	cena na vyžiadanie
DUH607	600mm	A	1911J2-4	48,99 €	413L92-6	cena na vyžiadanie
UH004G	600mm	A	191R53-9	89,59 €	412911-1	cena na vyžiadanie
UH005G	750mm	A	191R54-7	cena na vyžiadanie	412912-9	cena na vyžiadanie
UH006G	600mm	B	191R55-5	103,39 €	412911-1	cena na vyžiadanie
UH007G	750mm	B	191R56-3	179,59 €	412912-9	cena na vyžiadanie
UH008G	600mm	B	191R57-1	cena na vyžiadanie	459121-9	4,79 €
UH013G	600mm	A	191Y03-6	cena na vyžiadanie	413B98-4	cena na vyžiadanie
UH014G	750mm	A	191Y05-2	cena na vyžiadanie	413B99-2	cena na vyžiadanie

PRÍSLUŠENSTVO PRE ZÁHRADU

Vhodné pre model	Veľkosť noža	Typ noža	Nôž		Kryt noža	
			Obj. č.	MOC s DPH	Obj. č.	MOC s DPH

Akumulátorové nožnice na živý plot

*s chráničom noža, **bez chrániča noža

DUN461W, DUN460W	460mm		191P00-8	cena na vyžiadanie	413720-1	cena na vyžiadanie
DUN500W	500mm		191C14-9	87,79 €	458413-3	cena na vyžiadanie

Elektrické nožnice na živé ploty

UH4261	420mm	C	140826-9	29,19 €	452683-6	cena na vyžiadanie
UH4861	480mm	C	140830-8	cena na vyžiadanie	452684-4	cena na vyžiadanie
UH5261	520mm	C	140827-7	68,76 €	452685-2	cena na vyžiadanie
UH4570	450mm	C	194661-7	59,95 €	450489-6	cena na vyžiadanie
UH5570	550mm	C	194664-1	36,89 €	450489-6	cena na vyžiadanie
UH6570	650mm	C	194667-5	cena na vyžiadanie	450490-1	cena na vyžiadanie
UH5580	550mm	C	196687-5	87,39 €	450489-6	cena na vyžiadanie
UH6580	650mm	C	194674-8	64,56 €	450490-1	cena na vyžiadanie
UH7580	750mm	C	194676-4	71,93 €	450490-1	cena na vyžiadanie

Zberače odrezkov

• Pripevniteľné na obe strany noža



Vhodné pre model	Popis	Obj. č.	MOC s DPH
DUH202, *DUM111, *DUM604, UH201D, *UM110D, *UM600D, *UM603D	jednoduchá montáž / demontáž jedným zatlačením	198401-5	8,99 €
DUH551, DUH651, UH4570, UH5570, UH5580, UH6570, UH6580, UH7580	jednoduchá montáž / demontáž jedným zatlačením	194681-1	16,03 €
DUH483, DUH523, UH4261, UH4861, UH5261	5 ks skrutky M5 x 12 v balení	195050-9	21,89 €
DUH501, DUH502, DUH601, DUH602, DUH751, DUH752	jednoduchá montáž / demontáž jedným zatlačením	199151-5	cena na vyžiadanie
DUH502, DUH602, DUH752	jednoduchá montáž / demontáž jedným zatlačením	199152-3**	17,48 €
DUH507	jednoduchá montáž / demontáž jedným zatlačením	1910T1-0	cena na vyžiadanie
DUH607	jednoduchá montáž / demontáž jedným zatlačením	1910T2-8	31,49 €
DUH504S, DUH604S, UH013G	Bez skrutiek v balení (obj.č. skrutiek 915211-3)	191D33-1	19,59 €
DUH754S, UH014G	Bez skrutiek v balení (obj.č. skrutiek 915211-3)	191D34-9	25,99 €
UH004G, UH006G, UH008G	jednoduchá montáž / demontáž jedným zatlačením	191R51-3	30,29 €
UH005G, UH007G, UH009G	jednoduchá montáž / demontáž jedným zatlačením	191R52-1	49,29 €
DUN500W, DUN501W DUN600L	jednoduchá montáž / demontáž jedným zatlačením	191M40-8	cena na vyžiadanie
DUN461W UH460WD	jednoduchá montáž / demontáž jedným zatlačením	191T43-4	10,39 €

Predženie pre nožnice na trávnu



Vhodné pre model	Obj. č.	MOC s DPH
DUM604, *DUH202, UM110D, DUM111, UM600D, UM603D, *UH201D	198516-8	42,19 €

Nožnice na vinič a konáre (sada)

Vhodné pre model	Obj. č.	MOC s DPH
*DUP361, *DUP362	199311-9	176,39 €



Strihacie nožnice

Nôž horný

Nôž spodný



Nepoužívajte opätovne
zaistovaciu podložku E-4

Zaistovacia podložka E-4

So zaistovacou podložkou E-4 (obj.č. 961011-9)

Potrebné objednať skrutky M3x6

obj. č. 266183-8 a M8 251573-8

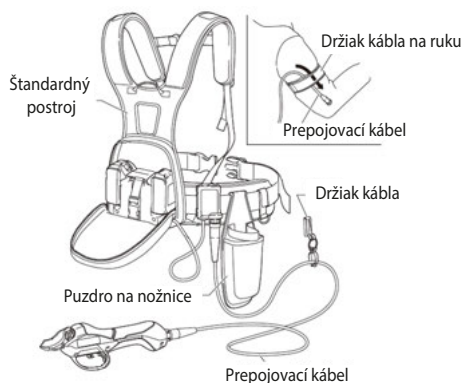

Vhodné pre model	Typ	Nôž horný		Nôž spodný	
		Obj. č.	MOC s DPH	Obj. č.	MOC s DPH
DUP361 DUP362	Štandard	197366-8	44,89 €	197367-6	43,19 €
	Pre tvrdé konáre	199216-3	69,99 €	199217-1	121,09 €
UP100D	Štandard	1911W2-5	cena na vyžiadanie	1911W1-7	cena na vyžiadanie

Ostatné príslušenstvo pre nožnice na vinič a konáre

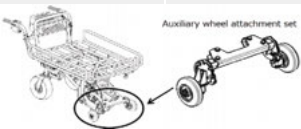

Vhodné pre model	Popis	Obj. č.	MOC s DPH
DUP361 DUP362	Štandardný postroj	161377-9	cena na vyžiadanie
	Puzdro na nožnice	161379-5	cena na vyžiadanie
	Držiak kábla na ruku	166062-9	5,62 €
	Držiak kábla	154511-8	cena na vyžiadanie
	Prepojavací kábel	661445-3	63,41 €

Nadstavce na fúrik

Vhodné pre model	Popis	Obj. č.	MOC s DPH
DCU180	 Rám	199009-8	185,59 €
	 Vaňa	199008-0	121,69 €
	Pomocné kolieska	191A01-6	85,79 €
	 Auxiliary wheel attachment set		
DCU603 DCU604 DCU605	 Vaňa max. objem 200 l max. objem kvapaliny 100 l	191B69-8	888,19 €
	 Adaptér vyklápania	191B63-0	778,69 €
	 Rám	191B67-2	480,39 €
	 Adaptér vyklápania	191B63-0	778,69 €
	 Vaňa max. objem 295 l max. objem kvapaliny 250 l	1911B3-6	1 034,29 €

Kolieska pre fúriky



hodné pre model	Popis	Farba	Obj. č.	MOC s DPH
DCU603 DCU604 DCU605	Koleso pre použitie v exteriéri Ø 330 mm, pneumatika 13 x 5,00 – 6, dušová	čierna	1911K4-7	88,19 €
	Koleso prepoužitie v interiéri, priemyselné podlahy, Ø 330 mm, pneumatika 13 x 5,00 – 6, dušová	sivá	1911K5-5	89,79 €
	Koleso prepoužitie v interiéri, priemyselné podlahy Ø 210 mm, pneumatika 2,00 – 4, dušová	Šedá pneumatika nezanecháva čmuhy na podlahách	1911K6-3	62,19 €

Nože pre kosačky s výsuvnými nožmi



Vhodné pre model	Bubon s výsuvnými nožmi			Náhradné nože		
	Velkosť	Obj. č.	MOC s DPH	ks/bal.	Obj. č.	MOC s DPH
DLM462, DLM465	460 mm	191D49-6	36,09 €	4	191D47-0	29,09 €
DLM530, DLM531, DLM532, DLM533, DLM535, DLM536, DLM537, LM001C, LM002G	530 mm	191D50-1	42,29 €	4	191D48-8	35,09 €

Náhradné valce pre elektrické vertikátory

Vhodné pre model	Obj. č.	MOC s DPH	
UV3200	 Prevzdušňovací nôž	652024718	26,39 €
	 Pružinový valec	652024719	28,59 €
UV3600	 Prevzdušňovací nôž	652024746	21,09 €
	 Kombinovaný valec	652024750	18,19 €

Mulčovacie klíny pre akumulátorové kosačky

Vhodné pre model	Obj. č.	MOC s DPH
DLM382 DLM432	191D46-2	10,29 €

Nože pre motorové kosačky

Vhodné pre model	Obj. č.	MOC (s DPH)
PM42, PM43	664531043	9,79 €
PM48, PM48S, PM480, PM480S4	664531048	12,49 €
PM530, PM530S, PM5175S1, 5165S3, PM5360S3, PM5360S3E	664004381	12,49 €
PM4660S1, PM4655S4, PM4860/S/S4	664004366	14,09 €
PM5120/S/R	DA00000944	10,79 €
PM410, PM411C	671001433	13,99 €
PM46N/S/C, PM460, PM461R, PLM4628N	DA00001274	16,49 €
PLM5113N2, PM5100S3, PM5101S3/S3C, PM5102S3/S3C	DA00000973	15,39 €
PM5600S3/S3C/R, PLM5600N2	671002532	18,09 €

Nože pre akumulátorové kosačky



Vhodné pre model	Velkosť	Obj. č.	MOC s DPH
Akumulátorové kosačky			
DLM380, DLM382	380 mm	191D41-2	13,59 €
DLM432	430 mm	191D43-8	14,99 €
DML460, DLM461, DLM463, DLM464	460 mm	199367-2	9,95 €
DLM462, DLM465	460 mm	191D51-9	19,49 €
LM001J, DLM480, DLM481, LM001G, LM001J	480 mm	191V97-3	26,09 €
DLM530, DLM531, DLM532, DLM533, DLM534, DLM535, DLM536, DLM537, LM001C	530 mm	191D52-7	26,19 €
DLM530, DLM532, DLM533, DLM536, LM001C	530 mm	*191W87-2	cena na vyziadanie
DLM538, DLM539, LM002G, LM002J	530 mm	191V96-5	24,39 €

Elektrické kosačky

ELM3320	330 mm	YA00000745	8,99 €
ELM3720	370 mm	YA00000746	10,29 €
ELM4120	410 mm	YA00000747	11,59 €
ELM4121	410 mm	YA00000738	9,89 €
ELM4620	460 mm	YA00000741	13,89 €
ELM4621	460 mm	YA00000741	13,89 €

Príslušenstvo pre akumulátorové zemné vrtáky DDG460 a DG001G



Vhodné na vrtanie do piesočnatej a hlinitej pôdy.

Zemné vrtáky

Priemer	Celková dĺžka	Pracovná dĺžka	Obj. č.
ø50 mm	800 mm	550 mm	E-13611
ø60 mm			E-13627
ø80 mm			E-13633
ø100 mm			E-07294
ø150 mm			E-07303
ø200 mm			E-07319

Predĺženie (540 mm)
E-07325

Poistka
E-07331

Adaptér typ D
327687-6

V porovnaní s našim predchádzajúcim vrtákom, ktorý má iba jednu špirálovú drážku, tento nový vrták má dve špirálové drážky, vďaka ktorým je vrtanie stabilnejšie. To tiež vedie k 10% zvýšeniu rýchlosti vrtania v porovnaní s predchádzajúcim vrtákom.

Dva rôzne typy rezných nožov (plochý a zubový).

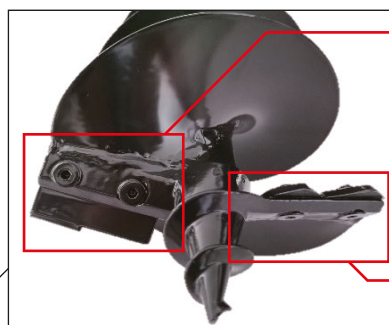

Plochý nôž



Plochý nôž, vhodný pre trávnaté plochy.

Zubový nôž



Zubový nôž, vhodný pre kamenkové pôdy.

Nože pre zemné vrtáky

(sady nožov komplet)

Priemer	Obj. č.	Priemer	Obj. č.
vrták 50 mm	E-13649	vrták 100 mm	E-07630
vrták 60 mm	E-13655	vrták 150 mm	E-07646
vrták 80 mm	E-13661	vrták 200 mm	E-07652

*Priemer 200 mm používať iba pre piesočnatú pôdu.

Príslušenstvo pre akumulátorové zemné vrtáky DDG460 a DG001G

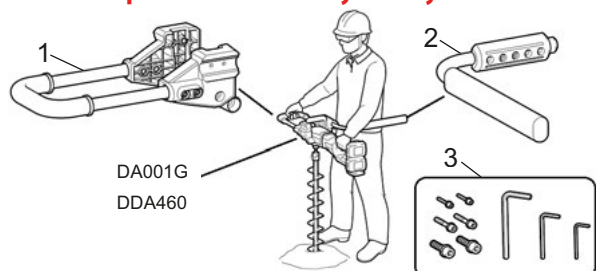

Príslušenstvo pre akumulátorový zemný vrták



DA001G
DDA460

Vhodné pre model	Popis	Obj. č.	MOC s DPH
DA001G, DA002G, DDA460	1-3set	191P11-3	94,49 €

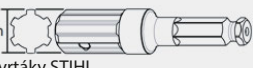
Adaptéry pre zemné vrtáky

Model		Obj. č.	MOC s DPH
DDG460, DG001G	20mm  pre vrtáky STIHL	327684-2	26,59 €
DA001G + 191P11-3	25.5mm  pre vrtáky Dolmar	327685-0	37,09 €
DDA460 + 191P11-3	20mm  pre vrtáky Makita	327687-6	21,89 €

Zemné vrtáky



Priemer (mm)	Celková dĺžka (mm)	Pracovná dĺžka (mm)	Obj. č.	MOC (s DPH)
50	800	550	E-13611	62,79 €
60	800	550	E-13627	68,19 €
80	800	550	E-13633	73,79 €
100	800	550	E-07294	64,59 €
150	800	550	E-07303	83,59 €
200	800	550	E-07319	81,49 €

Sety náhradných nožov nožov

	Vrták priemer (mm)	Obj. č.	MOC (s DPH)
	50	E-13649	7,09 €
	60	E-13655	7,39 €
	80	E-13661	7,89 €
	100	E-07630	7,19 €
	150	E-07646	7,99 €
	200	E-07652	9,29 €

Predĺženie

	Dĺžka (mm)	Obj. č.	MOC (s DPH)
	540	E-07325	23,99 €













Zaistovacia poistka

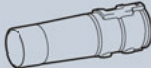

Obj. č.	MOC (s DPH)
E-07331	2,09 €

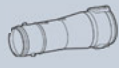
Príslušenstvo pre fukáre

- *použitie len s adaptérom rúry 71
- *použitie len s adaptérom rúry 80-72
- *použitie len s adaptérom rúry 85-72
- *použitie len s adaptérom rúry MG

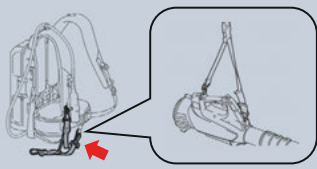
Vhodné pre model	Popis	Obj. č.	MOC s DPH
DUB184	Predaná rúra 	183P96-3	cena na vyžiadanie
DUB362	Predĺžená rúra 	183R02-0	cena na vyžiadanie
DUB363	Koncová rúra 72 	183R01-2	cena na vyžiadanie
DUB363	Predĺžovacia rúra 90-72 	183R06-2	cena na vyžiadanie
UB001C UB001G	Koncová rúra 80 	191P97-7	cena na vyžiadanie
DUB184** DUB362 DUB363 UB001C*** UB001G*** UB400MP**** UB401MP****	Dýza okruhlá 	197888-8	5,98 €
	Dýzy ploché 	197889-6	3,29 €
DUB184** DUB362* DUB363 UB001C*** UB001G*** UB400MP**** UB401MP****	Sada na čistenie okapov (celková dĺžka 2,9 m)  sada obsahuje: 3 x rúra 0,9 m 1 x dýza (otočné koleno) 3 x sťahovacia objímka	191B03-8	56,69 €
DUB362 DUB363	Rúra adaptér 71 	191J13-3	cena na vyžiadanie
DUB184	Rúra adaptér 80-72 	191L13-5	0,06 €
UB001C UB001G	Rúra adaptér 85-72 	191L96-5	6,99 €
UB400MP UB401MP	Rúra adaptér MG 	191C15-7	cena na vyžiadanie
UB001G DUB184 DUB362	Popruh jednoramenný 	166094-6	cena na vyžiadanie
UB001C + PDC1200 UB001C + PDC01	Popruh 	191J48-4	cena na vyžiadanie

Hubice pre fukáre

A: štandardne dodávané



Vhodné pre model	Dĺžka (mm)	Typ	Obj. č.	MOC s DPH
UB100D, UB101D, DUB185, DUB186	220	A	123245-4	3,79 €
	430	-	123246-2	cena na vyžiadanie

Štrbinová dýza



Použitie len s hubicou 132025-7

Vhodné pre model	Farba	Obj. č.	MOC s DPH
UB100D, UB101D, DUB185, DUB186	Gray	192236-6	5,69 €

Predĺžená hubica



Vhodné pre model	Obj. č.	MOC s DPH
UB100D, UB101D, DUB183, DUB185, DUB186	191G09-6	4,69 €

Zberný vak



Vhodné pre model	Obj. č.	MOC s DPH
UB100D, UB101D, DUB185, DUB186, UB1102, UB1103	123241-2	4,79 €
UB1100, UB1101	122321-1	2,69 €

Príslušenstvo pre vysávanie

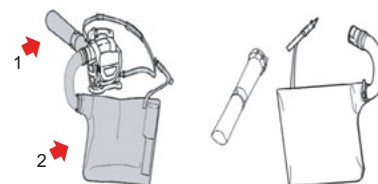

Vhodné pre model	Číslo	Popis	Obj. č.	MOC s DPH
DUB363	1+2	Sada na odsávanie	191E19-1	41,89 €
	2	Zberný vak	162697-4	18,89 €
DUB187		Dýza nasávania	GB00000165	5,19 €
		Zberný vak	GB00000185	cena na vyžiadanie
		Jednoramenný popruh	GB00000038	cena na vyžiadanie



Príslušenstvo pre vysokotlakové čističe DHW080, HW1200, HW1300

Typ	Vhodné pre model	Obj. č.	MOC s DPH
Striekacia pištoľ	DHW080 HW1200 HW1300	197842-2	16,89 €
Aretovateľná dýza	DHW080 HW1200 HW1300	197822-8	8,49 €
Vario tryska set	DHW080 HW1200 HW1300	191U88-8	22,09 €
Vario tryska set	DHW080 HW1200 HW1300	191U86-2	15,09 €
Predĺženie	DHW080 HW1200 HW1300	191U84-4	cena na vyžiadanie
Vario tryska	DHW080 HW1200 HW1300	197876-5	17,09 €
Turbo tryska	DHW080 HW1200 HW1300	197824-4	9,49 €
Kefa na podlahy	DHW080 HW1200 HW1300	197864-2	16,89 €
Zahnutá tryska	DHW080 HW1200* HW1300* (*for 110-127V) HW1200** HW1300** (**for 220V-240V)	197859-5 198909-9	cena na vyžiadanie 21,79 €
Predĺžovacia sada (0,9m / 1,3m / 1,7m)	DHW080 HW1200 HW1300	197870-7	32,09 €
Rotačná kefa	DHW080 HW1200 HW1300	197831-7	13,89 €
Kefa	DHW080 HW1200 HW1300	197828-6	6,39 €
Nádržka na saponát	DHW080 HW1200 HW1300	197886-2	15,19 €
Hadica na čistenie potrubia	DHW080 HW1200 HW1300	10m 197837-5 15m 197840-6	23,19 € 28,79 €
Vysokotlaková predĺžovacia hadica	DHW080 HW1200 HW1300	5m 197845-6 8m 197847-2 10m 197850-3	20,39 € 28,09 € 31,79 €

Typ	Vhodné pre model	Obj. č.	MOC s DPH
Spojka kĺbová	DHW080 HW1200 HW1300	197867-6	12,89 €
Nasávací hadica	DHW080 HW1200 HW1300	197873-1	28,69 €
Spojka trysky	DHW080 HW1200 HW1300	197853-7	5,09 €
Nadstavec na ventil	DHW080 HW1200 HW1300	197881-2	3,99 €
Spojka na prírodnú hadicu	DHW080 HW1200 HW1300	197883-8	3,09 €
Čistiaca ihla	DHW080 HW1200 HW1300	197879-9	1,49 €
Jednoramenný popruh	DHW080	199486-4	cena na vyžiadanie
Hadica 10 m	HW1300	TG00000009	92,34 €
Hadica 10 m	HW1200	123784-4	16,09 €



VYSOKOTLAKOVÉ ČISTIČE

(Makita)
HW102
(Dolmar)
HP-20

(Makita)
HW111
(Dolmar)
HP-300

(Makita)
HW112
(Dolmar)
HP-350

(Makita)
HW132
(Dolmar)
HP-450

(Makita)
HW151
(Dolmar)
HP-7000

Obj. č.

MOC s DPH



Striekacia pištoľ	☺	☺	☺			3320152	5,59 €
Striekacia pištoľ				☺		3640920	17,69 €
Striekacia pištoľ					☺	41154	21,29 €
Aretovateľná dýza	☺					3640640	2,29 €
Aretovateľná dýza		☺	☺			3640650	2,69 €
Aretovateľná dýza				☺		3641150	6,39 €
Aretovateľná dýza					☺	40246	21,49 €
Vysokotlaková hadica 5 m	☺					3640630	6,99 €
Vysokotlaková hadica 8 m		☺	☺	☺		3640960	50,09 €
Tryska napeňovacia		☺	☺	☺		3640670	1,49 €
Hadica na čistenie potrubia 8 m	☺	☺	☺	☺	☺	40863	36,69 €
Hadica na čistenie potrubia 16 m	☺	☺	☺	☺	☺	40864	65,89 €
Keňa na podlahy	☺	☺	☺	☺		41175	50,99 €
Filter na vodu	☺	☺	☺	☺	☺	40855	13,69 €
Filter na vodu	☺	☺	☺	☺	☺	3082130	1,09 €
Keňa na podlahy s nádržkou na čistiaci prostriedok					☺	41849	51,29 €
Univerzálny čistič 1 L	☺	☺	☺	☺	☺	40724	12,99 €

VYSOKOTLAKOVÉ ČISTIČE



	(Makita) HW101 (Dolmar) HP-110	(Makita) HW110 (Dolmar) HP-115	(Makita) HW130 (Dolmar) HP-135	(Makita) HW131 (Dolmar) HP-1500	Obj. č.	MOC s DPH
Striekacia pištoľ	☺				40797	12,79 €
Aretovateľná dýza	☺				40798	6,99 €
Aretovateľná dýza			☺		40879	12,29 €
Aretovateľná dýza				☺	40886	23,89 €
Turbo tryska				☺	40867	40,99 €
Vysokotlaková hadica 3 m	☺				3082290	17,57 €
Vysokotlaková hadica 5,5 m		☺			40856	19,39 €
Vysokotlaková hadica 7,5 m			☺		609 040 857	26,49 €
Hadica na čistenie potrubia 8 m		☺	☺		40863	36,69 €
Hadica na čistenie potrubia 16 m		☺	☺		40864	65,89 €
Hadica na čistenie potrubia 16 m				☺	609 040 866	69,09 €
Kefa	☺	☺	☺		40869	cena na vyžiadanie
Rotačná kefa				☺	609 040 897	20,99 €
Filter na vodu		☺	☺	☺	40855	13,69 €
Kefa na podlahy s nádržkou na čistiaci prostriedok				☺	41849	51,29 €

Akumulátory
Odkladacie systémy
Vítanie
Skrutkovanie
Brúsky
Pílenie
Frézovanie
Brúsenie
Klince / spony
Špeciálne stroje
Vysávanie
Fény/lampy
Záhraďa
Ručné náradie
Ostatné

zapaľovacie sviečky

	Zapaľovacia sviečka pre modely	Typ	Obj. č.	MOC (s DPH)
	PS-33, PS-330, PS-340/344, PS-400/401, PS-410/411	BPMR6F / NGK	965 603 018	3,94 €
	PS-2, PS-3, PS-4, PS-34, PS-36, PS-41, PS-43, PS-45, PS-3400 TH, PS-3410, PS-3410 TH, PS-350 C, PS-420 C, PS-460, PS-500, PS-500 C, PS-4600 S, PS-4605, PS-5000, PS-5105, PS-5105 C, PS-52, PS-630, PS-6100, PS-6400, PS-7300, PS-7310, PS-7900, PS-7910, PS-6000i, PS-6800i, PS-9000, PS-9010, 109, 110, 111, 115, 115i, LT-30, MS-20, MS-26, MS-2600, MS-24 U, MS-30 U, MS-30 C, MS-340, MS-3310, MS-400, MS-4010, MS-4200, MS-4211, MS-4510, PC-6112, PC-6114, PC-6212, PC-6412, PC-6414, PC-7414, PC-8116, PC-8216, 309, 343, PB-500 R, PD-520 R	BPMR7A / NGK	168517-0	2,70 €
	LT-250, MS-220, MS-250, MS-252, MS-2300, MS-3200, MS-3202, PB-250, HT-2256 D, HT-2276 E	BMR7A / NGK	381 014 981	3,19 €
	MS-250.4, MS-252.4 U, MS-352.4 U, MS-245.4U/UE, MS-335.4U, PS-222 TH, PS-32 C, PS-35 C, PB-7600.4	CMR6A / NGK	168401-9	3,59 €

zapaľovacie sviečky – servisné balenie

		ks/bal	Obj. č.	MOC (s DPH)
	WSR6F / Bosch	100	965 603 014*	5,03 €
	BPMR6F / NGK	100	965 603 018*	3,94 €
	BPMR7A / NGK	100	168517-0*	2,70 €

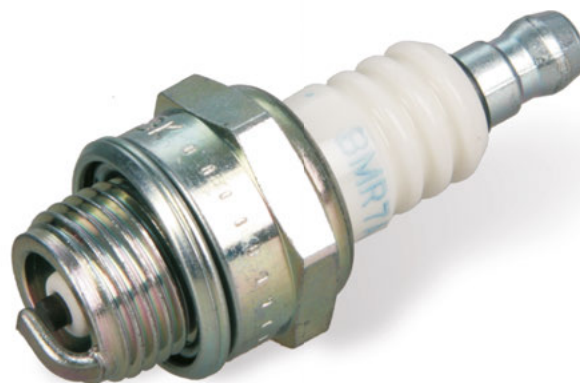







* cena za 1 ks

kombinované kľúče

		Obj. č.	MOC (s DPH)
	Kombinovaný kľúč 13/16 pre hobby píly.	941 716 132	2,09 €
	Kombinovaný kľúč 13/16 pre farmárske píly.	941 713 161	2,09 €
	montážny kľúč 13 / 16	782023-7	1,88 €
	Kombinovaný kľúč 19/13 pre profi píly.	941 719 133	1,89 €
	Kombinovaný kľúč 17/19 pre profi píly.	941 717 192	1,49 €
	Kombinovaný kľúč 13/19 pre hobby píly.	782028-7	1,99 €
	Kombinovaný kľúč 13 pre elektrické píly.	941 713 001	1,69 €

ŽACIE HLAVY





		Priemer lanka (mm)	ET-40, UR3000	ET-70,100C, LT-27,30	ET-71, 101C, UR3500, 3501	ET-110C, UR3502	LT250	LT245,4	MS-20U	MS-24,34U	MS-26,27U	CS-246,4	MS-260U	MS-330U	MS-430U	MS-3202UE
	Tap&Go	1,6	☺													
	Tap&Go	1,6		☺												
	Tap&Go	2,0			☺											
	Tap&Go	2,4														
	Tap&Go	2,4							☺		☺					
	Tap&Go	2,4								☺						
	Tap&Go	3,0														
	Tap&Go	3,0														
	Tap&Go	2,7								☺*		☺				
	Automatic	3,0											☺	☺	☺	
	Automatic	2,4					☺	☺								
	Automatic	2,4							☺	☺	☺	☺				☺

* len pre model MS-34

MS-4200JE	MS-4520U	MS-245,4,246,4U,JE,CE	MS-335,4UK	MS-5700U	MS-252,4U	MS-352,4UR	MS-252U	MS-340,341U	MS-400U	MS-3310U	MS-4010,4011U	MS-4510,4511U	MS-430,4,4300,4UR	Objednávacie číslo	MOC EUR s DPH
														DA00000001	6,39 €
														YA00000649	9,46 €
														YA00000681	12,49 €
												☺		122931-4	16,99 €
														DA00000500	13,59 €
														161341-0	15,39 €
												☺		196053-6	48,99 €
☺					☺	☺								366 224 010	20,19 €
		☺	☺											B-06507	17,59 €
								☺	☺	☺	☺	☺		384 224 503	53,19 €
														B-70518	18,89 €
		☺	☺				☺							B-02945	22,49 €

ŽACIE NOŽE

pre krovinořezy

		MS-20U	MS-24,34U	MS-26,27U	CS-246,4	MS-260U	MS-330U	MS-430U	MS-3202UE
	8 zubý vyžínací nôž 230x25,4	☺		☺					
	4 zubý žací nôž 230x25,4	☺	☺	☺	☺	☺	☺	☺	
	4 zubý žací nôž 255x25,4								☺
	3 zub nôž na burinu 255x25,4			☺					
	3 zub nôž na burinu 300x20								
	3 zub nôž na burinu 300x25,4								
	2 zub žací nôž 230x25,4	☺	☺	☺	☺	☺	☺	☺	
	Pilový kotúč na krovie 200x20								
	Pilový kotúč na krovie 225x20								

MS-4200UE	MS-4520U	MS-245,4,246,4U,UE,CE	MS-335,4U/K	MS-5700U	MS-252,4U	MS-352,4U/R	MS-252U	MS-340,341U	MS-400U	MS-3310U	MS-4010,4011U	MS-4510,4511U	MS-430,4,4300,4U/R	Objednávacie číslo	MOC (s DPH)
☺		☺	☺				☺						☺	362 224 180	12,19 €
☺		☺	☺		☺		☺						☺	D-66008	6,89 €
☺			☺			☺							☺	729023-6	8,19 €
		☺	☺			☺	☺						☺	385 224 340	15,59 €
										☺	☺	☺		385 224 130	8,89 €
			☺			☺							☺	385 224 150	18,19 €
☺		☺	☺		☺		☺						☺	197808-2	8,89 €
											☺	☺		385 224 171	19,59 €
										☺	☺	☺		385 224 161	22,89 €





















KRYTY ŽACÍCH HLÁV A NOŽOV

		ET-40, UR3000	ET-71/101, UR3500, 3501	ET-110, UR3502	MS-20U	MS22C	MS-24	MS-26U	MS-34U	CS-246,4
	kryt komplet								☺	
	kryt žacej hlavy		☺							
	kryt žacej hlavy			☺						
	kryt komplet	☺								
	kryt komplet				☺					
	kryt žacej hlavy						☺			
	kryt noža						☺			
	kryt komplet					☺				
	kryt komplet							☺		
	kryt noža							☺		
	kryt žacej hlavy							☺		
	kryt komplet									
	kryt noža									
	násuvný kryt žacej hlavy									
	kryt noža									
	kryt žacej hlavy							☺		
	kryt komplet									
	kryt noža									
	násuvný kryt žacej hlavy									
	kryt noža									
	kryt noža									☺
	násuvný kryt žacej hlavy									☺
	kryt noža									
	kryt komplet									
	kryt komplet									
	kryt noža									
	kryt komplet									
	kryt komplet									
	kryt pilového kotúča ø200mm									
	kryt pilového kotúča ø255mm									







MS-3202UE	MS-4200UE	MS-4520U	MS-245,4U/UE	MS-245,4/247,4CE	MS-246,4U/UE	MS-335,4U	MS-5700U	MS-352,4U/R	MS-252U	MS-340/400/341U	MS-3310 /4010 /4011/4510/4511	MS-430,4/4300,4U	Objednávacie číslo	MOC (s DPH)
													140424-9	6,29 €
													YA00000653	4,24 €
													YA00000636	4,00 €
													DA00000047	3,64 €
													6198014001	19,25 €
													DA00000526	3,94 €
													DA00000525	5,86 €
													6198014001	19,25 €
													6258064001	17,21 €
													6258065001	13,02 €
☺	☺												140424-9	6,29 €
	☺												6358008004	42,50 €
		☺					☺						542410/NE	7,62 €
		☺					☺						729200	4,31 €
			☺	☺									452260-4	5,18 €
					☺								452260-4	5,18 €
			☺	☺	☺	☺						☺	135 753-3	cena na vyžiadanie
						☺						☺	452 259-9	cena na vyžiadanie
								☺					XNR0000343	7,62 €
									☺				6258060002	18,00 €
									☺				6258061002	11,12 €
										☺			010 341 202	46,79 €
											☺		010 341 612	43,69 €
											☺		010 341 030	24,38 €
											☺		010 341 100	66,29 €

ŽACIE HLAVY

		Vhodné pre modely	Obj. č.	MOC (s DPH)
	žacia hlava	MS-260 U, MS-330 U, MS-430 U	B-06507 /351 502 030/	17,59 €
	kryt hlavy spodný	MS-260 U, MS-330 U, MS-430 U	351 502 032	10,68 €
	bubon silónu	MS-260 U, MS-330 U, MS-430 U	351 502 033	10,72 €
	kryt hlavy – domec	MS-260 U, MS-330 U, MS-430 U	351 502 031	11,57 €
	adaptér	MS-260 U, MS-330 U, MS-430 U	351 502 034	6,62 €
	veko hlavy	MS-20U, MS-26U, MS-245.4U,UE, MS-335.4U, MS-252U, MS-3202, MS-246.4 U/UE, MS-24U, CS-246.4 C/CBC, MS-247.4 CE	B-70390	3,90 €
	vnútorné telo hlavy	MS-20U, MS-26U, MS-245.4U,UE, MS-335.4U, MS-252U, MS-3202, MS-246.4 U/UE, MS-24U, CS-246.4 C/CBC, MS-247.4 CE	A-15986	2,10 €
	bubon silónu	MS-20U, MS-26U, MS-245.4U,UE, MS-335.4U, MS-252U, MS-3202, MS-246.4 U/UE, MS-24U, CS-246.4 C/CBC, MS-247.4 CE	A-15970	2,99 €
	adaptér M8 (LH)	MS-20U, MS-26U, MS-245.4U,UE, MS-335.4U, MS-252U, MS-3202, MS-246.4 U/UE, MS-24U, CS-246.4 C/CBC, MS-247.4 CE	A-16025	2,79 €
	očko nylonovej hlavy	MS-20U, MS-26U, MS-245.4U,UE, MS-335.4U, MS-252U, MS-3202, MS-246.4 U/UE, MS-24U, CS-246.4 C/CBC, MS-247.4 CE	A-15992	2,59 €
	kryt hlavy – domec	MS-20U, MS-26U, MS-245.4U,UE, MS-335.4U, MS-252U, MS-3202, MS-246.4 U/UE, MS-24U, CS-246.4 C/CBC, MS-247.4 CE	A-16003	11,99 €
	pružina	MS-20U, MS-26U, MS-245.4U,UE, MS-335.4U, MS-252U, MS-3202, MS-246.4 U/UE, MS-24U, CS-246.4 C/CBC, MS-247.4 CE	A-16097	2,79 €
	adaptér M10 (LH)	MS-20U, MS-26U, MS-245.4U,UE, MS-335.4U, MS-252U, MS-3202, MS-246.4 U/UE, MS-24U, CS-246.4 C/CBC, MS-247.4 CE	A-16031	3,16 €
	montážny kľúč	MS-20U, MS-26U, MS-245.4U,UE, MS-335.4U, MS-252U, MS-3202, MS-246.4 U/UE, MS-24U, CS-246.4 C/CBC, MS-247.4 CE	A-16069	2,49 €

		Vhodné pre modely	Obj. č.	MOC (s DPH)
	žacia hlava	MS-30C,U, MS-340 U, MS-400 U, MS-3310 U, MS-4010 U, MS-4011 U, MS-4510 U, MS-4511 U	384 224 503	53,19 €
	kryt hlavy spodný	MS-30C,U, MS-340 U, MS-400 U, MS-3310 U, MS-4010 U, MS-4011 U, MS-4510 U, MS-4511 U	384 224 520	10,07 €
	krytka nyl. hlavy spodná	MS-30C,U, MS-340 U, MS-400 U, MS-3310 U, MS-4010 U, MS-4011 U, MS-4510 U, MS-4511 U	384 224 530	9,07 €
	bubon silónu	MS-30C,U, MS-340 U, MS-400 U, MS-3310 U, MS-4010 U, MS-4011 U, MS-4510 U, MS-4511 U	385 224 571	8,96 €
	pružina	MS-30C,U, MS-340 U, MS-400 U, MS-3310 U, MS-4010 U, MS-4011 U, MS-4510 U, MS-4511 U	384 224 510	2,03 €
	adaptér (M10 × 1,25 L)	MS-30C,U, MS-340 U, MS-400 U, MS-3310 U, MS-4010 U, MS-4011 U, MS-4510 U, MS-4511 U	387 224 590	3,28 €
	adaptér (M12 × 1,5 L)	MS-30C,U, MS-340 U, MS-400 U, MS-3310 U, MS-4010 U, MS-4011 U, MS-4510 U, MS-4511 U	385 224 550	4,54 €
	skrutka hlavy horná	MS-30C,U, MS-340 U, MS-400 U, MS-3310 U, MS-4010 U, MS-4011 U, MS-4510 U, MS-4511 U	384 224 540	6,22 €
	očko nylónovej hlavy	MS-30C,U, MS-340 U, MS-400 U, MS-3310 U, MS-4010 U, MS-4011 U, MS-4510 U, MS-4511 U	385 224 560	2,64 €
	žacia hlava	MS-430.4 U, MS-4300.4 U	196053-6	48,99 €
	kryt hlavy vrchný	MS-430.4 U, MS-4300.4 U	453957-8	6,19 €
	kryt hlavy spodný	MS-430.4 U, MS-4300.4 U	453960-9	6,56 €
	Tap & Go tlačítko	MS-430.4 U, MS-4300.4 U	453961-7	3,08 €
	bubon silónu	MS-430.4 U, MS-4300.4 U	453958-6	4,22 €
	prevodová doska	MS-430.4 U, MS-4300.4 U	453956-0	5,17 €
	pružina	MS-430.4 U, MS-4300.4 U	234260-4	2,53 €
	pružina	MS-430.4 U, MS-4300.4 U	234259-9	5,41 €
	skrutka hlavy M10	MS-430.4 U, MS-4300.4 U	318918-4	3,85 €
	očko nylónovej hlavy	MS-430.4 U, MS-4300.4 U	318917-6	1,43 €
	platnička	MS-430.4 U, MS-4300.4 U	453955-2	3,95 €

ŽACIE HLAVY

		Vhodné pre modely	Obj. č.	MOC (s DPH)
	žacia hlava	MS-20 U, MS-26 U, MS-252 U, MS-27 U	DA00000500	13,59 €
	kryt hlavy spodný	MS-20 U, MS-26 U, MS-252 U, MS-27 U	DA00000168	2,81 €
	bubon silónu	MS-20 U, MS-26 U, MS-252 U, MS-27 U	DA00000166	2,76 €
	kryt hlavy – domec	MS-20 U, MS-26 U, MS-252 U, MS-27 U	DA00000440	3,79 €
	pružina	MS-20 U, MS-26 U, MS-252 U, MS-27 U	DA00000165	0,70 €
	podložka spodná	MS-20 U, MS-26 U, MS-252 U, MS-27 U	DA00000164	0,31 €
	podložka vrchná	MS-20 U, MS-26 U, MS-252 U, MS-27 U	DA00000164	0,31 €

		Obj. č.	MOC (s DPH)
	Klin plastový 14 cm.	945 900 001	9,69 €
	Klin plastový 20 cm.	988 070 819	7,29 €
	Klin plastový 25 cm.	988 070 824	7,79 €
	Klin hliníkový – duralový 26 cm.	988 070 101	34,39 €
	Klin z tvrdého dreva pre nasadzovanie násad na sekery, kladivá 43 mm.	988 090 090	0,69 €
	Klin z tvrdého dreva pre nasadzovanie násad na sekery, kladivá 50 mm.	988 090 080	0,69 €

príslušenstvo



		Obj. č.	MOC (s DPH)
	Meracie pásmo 15 m	988 050 615	55,39 €
	Meracie pásmo 20 m	988 050 620	60,49 €
	Označovacia krieda modrá 12 ks/bal	988 050 730	10,99 €

ŽACIE NOŽE

unášače pre elektrické kosačky

	EM3310/3511	EM33	EM3713/3913	EM37	EM330	EM370	EM380/ ELM3800	EM331/ ELM3320	EM371/ ELM3720
	☺		☺				☺		
	☺		☺						
		☺		☺	☺	☺			
							☺		
		☺		☺	☺	☺		☺	
									☺
									☺

unášače pre benzínové kosačky

	PM410/460/462C/4602S /5102S3/S3C/4600S/S3/ 5101S3/S3C/5600S3/S3C PLM5113N2	PM42/43/48/480/530 /4860	PM46/N/S/SBC PLM4628N	PM4601S/SC/S3C/ 461/4602SC/S3C/5100S3	PM4602SR/5600S3R PLM5600N2	PM4660S1/5175S1/ 4860S/S4/5360S3/ S3E/5365S3pro	PM4655S4	PM4810/4820/S
	☺			☺	☺			
	☺			☺	☺			☺
		☺				☺		
			☺					
							☺	

EM41	EM4316	EM460/460S	EM461/S	EM4818/S	EM410/ ELM4120	EM411/ ELM4121	EM462/463S ELM4620/4621	Obj. č.	MOC (s DPH)
								DA00000917	1,49 €
								664 465 602	10,12 €
				☺				664 998 186	11,58 €
								671 492 001	9,89 €
			☺					671 005 057	4,70 €
		☺						671 478 001	9,69 €
							☺	YA00001066	2,03 €
								664 004 352	4,54 €
				☺				664 793 101	0,78 €
			☺					671 100 802	0,35 €
								671 006 017	0,50 €
☺		☺						671 100 802	0,35 €
					☺	☺		YA00000827	0,60 €
							☺	YA00001067	1,39 €

PM5120	PM5120S	PM5165S3	Obj. č.	MOC (s DPH)
			671 002 977	5,62 €
			664 463 012	13,66 €
			664 465 607	23,05 €
☺			671 002 051	4,97 €
	☺		671 002 049	8,93 €
			671 002 448	6,20 €
		☺	664 465 608	23,50 €
		☺	664 735 698	2,68 €
☺			DA00000528	0,97 €

MULČOVACIE KLINY

pre elektrické kosačky

	EM460/S	EM461/S	EM4818/S
			
	☺		☺
		☺	

pre benzínové kosačky

	PM410/411	PM46SBC/ PLM4628N	PM460/4600S/S3	PM462/C/ 4602SSC/S3C/R 5102S3/S3C	PM461/46N/ S/4601S/SC/ S3/S3C
					
	☺	☺	☺*		
			☺*		☺
				☺	

*model 2009 – 2011

**model 2012

***model 2017

EM411/ELM4121	EM462/463S, ELM4620/4621	Obj. č.	MOC (s DPH)
	☺	YA00001047	4,39 €
☺		YA00000978	12,44 €
		664 140 223	12,99 €
		671 469 001	11,39 €
		DA00000844	cena na vyžiadanie

PM48/S/480/S4	PM530/S	PM4860S/S4/S4E /4660S1/4655S4/ 5165S3/5175S1/ 5360S3/S3E/S3pro	PM5100S3/ 5101S3/S3C/ PLM5113N2	PM5600S3/S3C/R/ PLM5600N2	Obj. č.	MOC (s DPH)
☺					664 140 223	12,99 €
	☺				664 140 222	25,99 €
					671 326 001	11,99 €
			☺*		671 450 001	11,02 €
					671 660 001	10,69 €
					DA00000844	cena na vyžiadanie
		☺*			664 140 224	cena na vyžiadanie
				☺	671 315 001	11,89 €

prevodník strojov Makita/Dolmar

Dolmar	Makita	Dolmar	Makita	Dolmar	Makita
AH-1848	UH482DW	MS-252.4 U	BCX2500	PS-3410 TH	DCS3410TH
AH-1852	UH522DZ	MS-253	RBC2510	PS-35	EA3502S
AH-1852 H	DUH523Z	MS-26 C	DBC260L	PS-35 C	EA3500S
AK-3622	UK360	MS-26 U	DBC260U	PS-35 C TLC	EA3501S
AL-3630	BUR360Z	MS-260 C	BCM2610	PS-35 TLC	EA3503S
AM-3643	LM430DZ	MS-260 U	BCM2600	PS-350	DCS3500, MDE350
AS-1212	DUC122DZ	MS-290 C	DBC291	PS-350	DCS3500, MDE350
AS-1813	DUC122	MS-290 U	DBC290	PS-350 C	DCS3501, MDE354
AS-3625	DUC250	MS-30 C	DBC301	PS-350 S	EA3501F
AS-3626	DUC252	MS-30 U	DBC300	PS-350 SC	EA3500F
AT-1826	UR180DZ	MS-3202	RBC3101	PS-400	DCS400, MDE400
AT-1826 H	DUR181Z	MS-330 C	BCM3310	PS-401	DCS401, DE4040
AX-1820	UM167DZ	MS-330 U	BCM3300	PS-410	DCS410
AX-1820 H	DUM168Z	MS-3310	DBC3310	PS-411	DCS411
SP-1815	BVF154RF	MS-335.4 U	EBH341U	PS-420	DCS4300, MDE430
PB-250	RBL250, EUB251	MS-340	DBC340	PS-420 C	DCS4301, MDE435
PB-250.4	BHX2500	MS-352.4 C	BCX3410	PS-420 C	DCS4301, MDE435
PB-250.4 V	BHX2510	MS-352.4 R	EBH341R	PS-420 S	EA4301F
PB-252.4	BHX2501	MS-352.4 U	BCX3400	PS-420 SC	EA4300F
PB-252.4 V	BHX2511	MS-400	DBC400	PS-45	DCS4610
PB-7600.4	BBX7600	MS-4010	DBC4010	PS-460	DCS460
PB-7600.4	BBX7600	MS-4200 E	RBC420E	PS-4600 S	DCS4600S
CS-246.4 C	EX2650L	MS-4205	RBC412U	PS-4600 SH	DCS4600SH
ET-100 C	UM4030	MS-4211	RBC421L	PS-4605	DCS4630
ET-40	UR3000	MS-430 U	BCM4300	PS-500	DCS500
ET-70 C	UM3830	MS-430.4 C	EM4350LH	PS-500 C	DCS5121
ET-101C	UR3501	MS-430.4 U	EM4350UH	PS-5000	DCS5000
ET-110C	UR3502	MS-4300.4 U	EM4351UH	PS-5000 D	DCS5001, DE5045
LT-245.4	ER2550LH	MS-4510	DBC4510	PS-5000 H	DCS5000H
LT-250	RST250	PE-251	ETR2500	PS-5000 HD	DCS5001H
LT-30	DST300	ES-152 A	UC3001A	PS-5105	DCS5030
MS-20 C	RBC201	ES-162 A	UC3501A	PS-5105 C	EA5000P
MS-20 U	RBC200, MEM201	ES-172 A	UC4001A	PS-5105 D	DCS5031
MS-22 C	RBC2110	ES-2035 A	UC3503A	PS-6100	EA6100P
MS-23 C	EM2301L	ES-2040 A	UC4003A	PS-6400	DCS6400
MS-23 U	EM2301U	ES-2135 AP	UC3530AP	PS-7300	DCS7300
MS-230 C	BCM2310	ES-2140 AP	UC4030AP	PS-7310	EA7300P
MS-24 U	EM2500U	ES-33 A	UC3020A	PS-7900	DCS7900
MS-245.4 C	EBH252L	ES-38 A	UC3520A	PS-7900	DCS7901
MS-245.4 CE	EBH253L	ES-42 A	UC4020A	PS-7910	EA7900P
MS-245.4 U	EBH252U	109	DCS430	PS-9010	DCS9010
MS-245.4 UE	EBH253U	111	DCS520	PD-491	PD491
MS-246.4 C	EM2650L	115	DCS5200	PD-520	BBA520
MS-246.4 CE	EM2651L	109 Happy Start	DCS431, DE4345	HT-140	UH4050
MS-246.4 UE	EM2651U	PS-221 TH	DCS231T	HT-148	UH4850
MS-25 C	DBC251	PS-222 TH	DCS232TH	HT-155	UH5550
MS-25 CS	DBC251S	PS-32 C	MEA3200S	HT-163	UH6350
MS-25 U	DBC250	PS-32 C TLC	EA3201S	HT-345	UH4570
MS-25 US	DBC250S	PS-34	DCS34	HT-355	UH5570
MS-251.4	EM4251, MEM425	PS-340	DCS340	HT-365	UH6570
MS-252	RBC2500	PS-341	DCS341	HT-42	UH4260
MS-252.4 C	BCX2510	PS-3410	DCS3410	HT-43	UH4261

Dolmar	Makita	Dolmar	Makita	Dolmar	Makita
HT-4500	UH4540	PM-4600 S	PLM4611	MH-2556	PTR2500
HT-48	UH4860	PM-4600 S3	PLM4612	EE-150	UW2500
HT-49	UH4861	PM-4601 S	PLM4621	MP-245.4	MEW1050H
HT-52	UH5260	PM-4601 S3	PLM4622	MP-245.4 Z	EW1050HX
HT-53	UH5261	PM-4602 S	PLM4631	MP-335.4	MEW1060H
HT-5500	UH5540	PM-4602 S3	PLM4632	MP-335.4 Z	EW1060HX
HT-5510	UH5580	PM-461	PLM4620	MP-352.4	EPH1000
HT-6500	UH6540	PM-462	PLM4630	MP-352.4 Z	EPH1000
HT-6510	UH6580	PM-4655 S4	PLM4816	HP-10	HW101
HT-7510	UH7580	PM-4660 S1	PLM4815	HP-115	HW110
HT-2249 D	HTR4901	PM-48	PLM4600	HP-135	HW130
HT-2350 D	EH5000W	PM-48 S	PLM4601	HP-1500	HW131
HT-2360 D	EH6000W	PM-480	PLM4602	HP-20	HW102
HT-2375 D	EH7500W	PM-480 S4	PLM4603	HP-300	HW111
HT-245	HTS4500	PM-4855 SA pro	PLM4814	HP-350	HW112
HT-2460	EH6000S	PM-4860	PLM4810	HP-400	HW121
HT-2475	EH7500S	PM-4860	PLM4810	HP-450	HW132
HT-255	HTS5500	PM-4860 S	PLM4811	HP-6000	HW140
HT-2556 D	HTR5600	PM-4860 S4	PLM4812	HP-7000	HW151
HT-2576 E	HTR7610	PM-4860 S4E	PLM4813	HP351	HW1200
HT-2950	HTS5000	PM-5100 S3	PLM5102	HP401	HW1300
HT-2960	HTS6000	PM-5101 S3	PLM5113	EV-3213	UV3200
HT-2975	HTS7500	PM-5101S3R	PLM5113N2	EV-3618	UV3600
EM-33	ELM3310	PM-5102 S3	PLM5130	EV-3918	UV380
EM-330	ELM3311	PM-5120	PLM5120	PV-3936	EUV400
EM331	ELM3320	PM-5120 S	PLM5121	FH-2500	UD2500
EM-3511	ELM3300	PM-5165 S3	PLM5115	SP-7600.4	PM7650H
EM-37	ELM3710	PM-5175 S1	PLM5114	EP-132	PF0800
EM371	ELM3720	PM-530	PLM5100	EP-144 D	PF1010
EM-370	ELM3711	PM-530 S	PLM5101	EP-1500 DS	PF1110
EM-3913	ELM3700	PM-5360 S3	PLM5110	EP-1680 S	PF1100
EM-41	ELM4110	PM-5360 S3E	PLM5112	EP-720 S	PF0403
EM410	ELM4120	PM-5365 S3 pro	PLM5111	EP-84	PF0300
EM411	ELM4121	PM-5600 S3	PLM5600	EP-84 D	PF0410
EM-4316	ELM4100	PM-5600S3R	PLM5600N2	EP-960 DS	PF0610
EM-460	ELM4610	RM-63.7	PRM0600		
EM-460 S	ELM4611	RM-72.13 H	PRM0700		
EM-461	ELM4612	TM-102.16	PTM1000		
EM-461 S	ELM4613	TM-102.16 H2	PTM1003		
EM462	ELM4620	TM-102.18 H	PTM1001		
EM463S	ELM4621	TM-102.20 H2	PTM1002		
EM-4818	ELM4600	TM-122.22 H2	PTM1200		
EM-4818 S	ELM4601	TM-92.14	PTM0900		
PM-410	PLM4110	TM-92.14 H	PTM0901		
PM-411	PLM4120	TM-92.14 H2	PTM0903		
PM-42	PLM4100	TM-98.14 H2D	PTM0902		
PM-43	PLM4101	TM-98.14 H2D	PTM0902		
PM-46	PLM4616	RM-72.13 H	PRM0700		
PM-46 N	PLM4617	LS-6002	MLS6000		
PM-46 S	PLM4618	MH-246.4 D	EN4950H		
PM46SBC	PLM4628	MH-246.4 DS	EN5950SH		
PM-460	PLM4610	MH-246.4 ES	EN7350SH		

PRÍSLUŠENSTVO

▣ Ručné náradie



Zvinovacie metre



Funkcia

1. Špeciálny náter

* „DURA COAT“ je 5-krát odolnejší

* „SILICA COAT“ možnosť písania



2. Vysoká odolnosť háčika

* Inštalovaný doraz, tlmi nárazy háčika

* Chránič háčika znižuje otrasy háčika

* Pevne uchytený háčik štyrmi nitmi s chráničom



3. Výhody

* Obojstranná podtláč

* Háčik s magnetom

* Matný povrch, uľahčuje čítanie stupnice pri ostrom svetle

* Výsuv bez zalomenia



Tape measure



Jednotka	Dĺžka	Šírka	Obj. č.	MOC s DPH
cm	2m	13mm	E-03078	6,19 €



Jednotka	Dĺžka	Šírka	Obj. č.	MOC s DPH
cm	3.5m	16mm	B-57130	9,79 €

Skrutkovače okrúhli profil



	Veľkosť	Dĺžka (mm)	Obj. č.	MOC s DPH
+	PH1	100	B-65903	5,59 €
	PH2	100	B-65919	6,49 €
	PH3	150	B-65931	7,89 €
+	PZ1	80	B-65947	4,49 €
	PZ2	100	B-65953	6,09 €
	PZ3	150	B-65969	7,79 €
*	T10	100	B-65975	4,89 €
	T15	100	B-65981	4,89 €
	T20	100	B-65997	4,59 €
	T25	100	B-66008	5,79 €
-	T30	100	B-66014	6,09 €
	SL4.0	100	B-66020	4,49 €
	SL5.5	100	B-66036	5,69 €
	SL6.5	125	B-66042	5,39 €
	SL8	150	B-66058	7,09 €

Skrutkovače hranatý profil



	Veľkosť	Dĺžka (mm)	Obj. č.	MOC s DPH
+	PH1	75	B-66064	5,49 €
	PH2	100	B-66070	6,47 €
	PH3	150	B-66086	8,88 €
+	PZ1	75	B-66092	5,89 €
	PZ2	100	B-66101	6,09 €
	PZ3	150	B-66117	9,79 €

Sady ručných skrutkovačov

E-10528

30,19 € (MOC s DPH)

PH1, PH2, PZ1, PZ2, SL4, SL5,5

KS. / bal. – 6

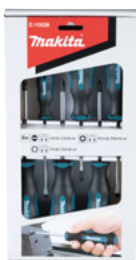

Sady ručných skrutkovačov

E-10534

26,99 € (MOC s DPH)

T10, T15, T20, T25, T30

KS. / bal. – 5



Nárazový skrutkovač

Makita nárazový skrutkovač je veľmi účinný na povolovanie poškodených alebo zalomených skrutiek



Použitie

1. Držte pevne skrutkovač pri použití

2. Silným úderom kladiva povelte skrutku

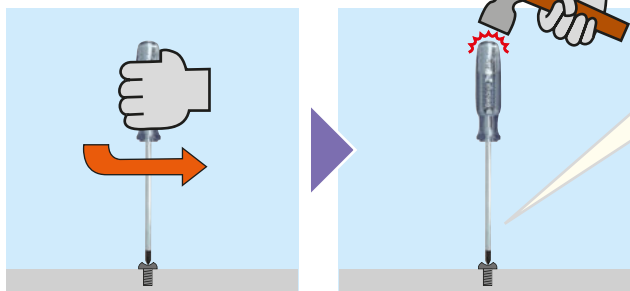

Nárazový skrutkovač dokáže odstrániť skrutky s poškodenou alebo úplne zničenou hlavičkou. Úderom kladiva na rukoväť sa vytvorí krútiaci moment smere otáčania, takže je možné skrutky s poškodenou alebo úplne zničenou hlavičkou.



*Úderom na rukoväť sa vytvára 12 stupňový krútiaci moment v smere povolovania, čo umožní povoliť poškodenú skrutku

12 degrees

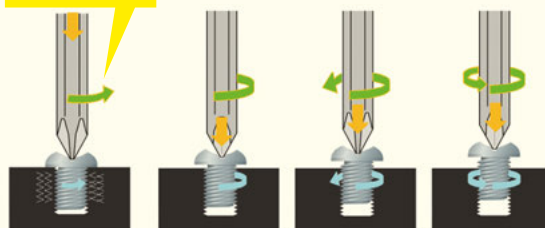

	Velkosť	Dĺžka (mm)	Obj. č.	MOC s DPH
+	PH2	125	B-42438	18,79 €
	PH3	150	B-42444	21,29 €
*	PZ2	125	B-42450	18,59 €
	PZ3	150	B-42466	21,29 €

Sada imbusových kľúčov 9ks



Velkosť	Obj. č.	MOC s DPH
1,5, 2, 2,5, 3, 4, 5, 6, 8, 10mm	B-65894	13,09 €

Pracovné rukavice – L

P-84470

38,89 € (MOC s DPH)

Odolné a priedušné pracovné rukavice s mimoriadne odolnými švami proti roztrhnutiu. Obzvlášť vysoká odolnosť vďaka viacnásobnému zosilneniu v oblasti prstov. Dvojitá vrstva a dvojitá ochrana v oblasti kĺbov a záprstných kostí z pružného materiálu odolného voči oderu. Flexibilné nastavenie šírky pomocou suchého zipsu.

Pracovné rukavice – XL

P-84486

43,89 € (MOC s DPH)

Odolné a priedušné pracovné rukavice s mimoriadne odolnými švami proti roztrhnutiu. Obzvlášť vysoká odolnosť vďaka viacnásobnému zosilneniu v oblasti prstov. Dvojitá vrstva a dvojitá ochrana v oblasti kĺbov a záprstných kostí z pružného materiálu odolného voči oderu. Flexibilné nastavenie šírky pomocou suchého zipsu.

SPONY PRE PREPRAVNÉ KUFRE

model	kufor	spohna	MOC s DPH	model	kufor	spohna	MOC s DPH
1050DWA	824544-4	417059-4	0,16 €	6222DWE	824715-3	186347-7	1,19 €
1806B	821137-8			6223DWE	824510-1	186347-7	1,19 €
1902	182113-0			6226DWE	824635-1	186347-7	1,19 €
1923H	182113-0			6227DWE	824635-1	186347-7	1,19 €
2012NB	824002-0			6228DWE	824635-1	186347-7	1,19 €
2107FK	824728-4	163455-1	1,18 €	6261DWE	824853-1	163455-1	1,18 €
3612/C	P-38314			6261DWLE	824853-1	163455-1	1,18 €
3620	P-38314			6271DWAE	824853-1	163455-1	1,18 €
3901	824540-2	417059-4	0,16 €	6271DWALE	824581-8		
4112HS	824697-9	163467-4	2,56 €	6271DWPE	824853-1	163455-1	1,18 €
4304	824809-4			6281DWAE	824853-1	163455-1	1,18 €
4304T	824809-4			6281DWALE	824581-8		
4305	824809-4			6313DWAE	824476-5	416661-0	1,29 €
4305T	824809-4			6313DWBE	824476-5	416661-0	1,29 €
4326	824572-9	186347-7	1,19 €	6314DWAE	824635-1	186347-7	1,19 €
4327	824572-9	186347-7	1,19 €	6316DWAE	824525-8	417075-6	6,49 €
4329	824572-9	186347-7	1,19 €	6316DWBE	824525-8	417075-6	6,49 €
4331DWD	824553-3	416661-0	1,29 €	6317DWDRE	183763-4	417724-5	0,89 €
4334DWD	824553-3	416661-0	1,29 €	6319DWFE	824626-2	450909-0	0,26 €
4350CT/FCT	824809-4			6327DWE	824635-1	186347-7	1,19 €
4351CT/FCT	824809-4			6328DWE	824635-1	186347-7	1,19 €
4604DW	824556-7	416401-6	2,62 €	6333DWAE	824476-5	416661-0	1,29 €
5017RKB	193196-5	183336-3	1,41 €	6333DWBE	824476-5	416661-0	1,29 €
5103R	P-15942			6336DWAE	824525-8	417075-6	6,49 €
5603R	824606-8	183336-3	1,41 €	6336DWBE	824525-8	417075-6	6,49 €
5604R	824555-9			6337DWDESP	183763-4	417724-5	0,89 €
5621RDWA	824533-9	417075-6	6,49 €	6339DWFE	824626-2	450909-0	0,26 €
5703RK	824606-8	183336-3	1,41 €	6343DWAE	824525-8	417075-6	6,49 €
5704R	824555-9			6343DWBE	824525-8	417075-6	6,49 €
5705RK	824606-8	183336-3	1,41 €	6347DWDESP	183763-4	417724-5	0,89 €
5903R	193196-5	183336-3	1,41 €	6349DWFE	824626-2	450909-0	0,26 €
6016DW	824723-4			6380	824744-6		
6017DWE	824723-4			6381DWAE	824852-3	163455-1	1,18 €
6018DWE	824723-4			6390	824744-6		
6019DWE	824723-4			6391DWAE	824853-1	163455-1	1,18 €
6019DWE	824723-4			6391DWALE	824853-1	163455-1	1,18 €
6095DWE	824723-4			6503DWDE	824635-1	186347-7	1,19 €
6095DWE	824723-4			6704DW	824380-8		
6096DWE	824723-4			6800DBV	824700-6		
6096DWE	824723-4			6802DBV	824700-6		
6203DWAE	824476-5	416661-0	1,29 €	6805DBV	824700-6		
6203DWBE	824476-5	416661-0	1,29 €	6822	824700-6		
6204DWAE	824653-1	186347-7	1,19 €	6824	824449-8		
6207DWDE	183763-4	417724-5	0,89 €	6825R	824449-8		
6213DWAE	824476-5	416661-0	1,29 €	6826	824449-8		
6213DWBE	824476-5	416661-0	1,29 €	6827	824449-8		
6214DWAE	824635-1	186347-7	1,19 €	6830	824421-0		
6216DWAE	824525-8	417075-6	6,49 €	6831DWH	824551-7	417075-6	6,49 €
6216DWBE	824525-8	417075-6	6,49 €	6832	824421-0		
6221DWE	824715-3	186347-7	1,19 €	6833	824421-0		

Akumulátory
 Odkladacie systémy
 Vŕtanie
 Skrutkovanie
 Brúsky
 Pílenie
 Frézovanie
 Brúsenie
 Klince / spony
 Špeciálne stroje
 Vysávanie
 Fény/lampy
 Záhrada
 Ručné náradie
 Ostatné

SPONY PRE PREPRAVNÉ KUFRE

model	kufor	spóna	MOC s DPH	model	kufor	spóna	MOC s DPH
6834	824421-0			AN621	824582-6		
6835DWH	824551-7	417075-6	6,49 €	AN711H	824792-5		
6842	824808-6	163455-1	1,18 €	AN901	824545-2	417075-6	6,49 €
6844	824808-6	163455-1	1,18 €	AN911H	824792-5		
6904VH	824439-1			AN943K	824841-8		
6905B	824698-7			BCS550RFE	824802-8	163455-1	1,18 €
6905H	824698-7			BDA340RFE	824851-5	163455-1	1,18 €
6906	182604-1			BDA341RFE	824851-5	163455-1	1,18 €
6908DWA	824635-1	186347-7	1,19 €	BDA350Z	824816-7	163455-1	1,18 €
6914DWA	824635-1	186347-7	1,19 €	BDA351Z	824816-7	163455-1	1,18 €
6915DWA	824549-4	186347-7	1,19 €	BDF343SHE	824862-0	163455-1	1,18 €
6916DWA	824635-1	186347-7	1,19 €	BDF430F	824710-3	417724-5	0,89 €
6918DWA	824635-1	186347-7	1,19 €	BDF440RFE	824753-5	417724-5	0,89 €
6918FDWDE	824635-1	186347-7	1,19 €	BDF441RFE	824754-3	417724-5	0,89 €
6934FDWDE	824635-1	186347-7	1,19 €	BDF442RFE	824774-7	417724-5	0,89 €
6935FDWDE	824635-1	186347-7	1,19 €	BDF450RFE	824753-5	417724-5	0,89 €
6936FDWDE	154902-3			BDF451RFE	824754-3	417724-5	0,89 €
6940DW	824686-4			BDF452RFE	824774-7	417724-5	0,89 €
6951	824439-1			BDF453SHE	824862-0	163455-1	1,18 €
6953	824630-1	186347-7	1,19 €	BDF460SH	153514-9	417075-6	6,49 €
6960DWA	824635-1	186347-7	1,19 €	BFR440RFE	824756-9	417059-4	0,16 €
6980FDWDE	824710-3	417724-5	0,89 €	BFR540RFE	824807-8	163455-1	1,18 €
8271DWAE	824853-1	163455-1	1,18 €	BFR550RFE	824807-8	163455-1	1,18 €
8281DWAE	824853-1	163455-1	1,18 €	BFR750RFE	824807-8	163455-1	1,18 €
8281DWAET2	149504-3			BFS230F	824710-3	417724-5	0,89 €
8281DWALE	824853-1	163455-1	1,18 €	BFS440Z	824756-9	417724-5	0,89 €
8381DWAE	824852-3	163455-1	1,18 €	BFS450Z	824756-9	417724-5	0,89 €
8391DWAE	824853-1	163455-1	1,18 €	BGA450RFE	824767-4	163455-1	1,18 €
8391DWALE	824853-1	163455-1	1,18 €	BGA452RFE	824767-4	163455-1	1,18 €
8413DWDE	824626-2	450909-0	0,26 €	BHP343SHE	824862-0	163455-1	1,18 €
8414DWFE	824626-2	450909-0	0,26 €	BHP440RFE	824753-5	417724-5	0,89 €
8433DWDE	824626-2	450909-0	0,26 €	BHP441RFE	824754-3	417724-5	0,89 €
8434DWFE	824626-2	450909-0	0,26 €	BHP442RFE	824774-7	417724-5	0,89 €
8443DWDE	824626-2	450909-0	0,26 €	BHP450RFE	824753-5	417724-5	0,89 €
8444DWFE	824626-2	419655-4	cena na vyžiadanie	BHP451RFE	824754-3	417724-5	0,89 €
9554NB	824736-5			BHP452RFE	824774-7	417724-5	0,89 €
9555NB	824736-5			BHP453SHE	824862-0	163455-1	1,18 €
9557HN	188627-7			BDF / BHP456	141856-3	162302-3	0,99 €
9558HNK	188627-7			BHP460SH	153514-9	417075-6	6,49 €
9562CH/CVH	188627-7			BHR162RFE	824815-9	417724-5	0,89 €
9564H	188627-7			BHR200SF	824690-3	417152-4	1,07 €
9565CR/CVR	188627-7			BHR200SJE	824690-3	417152-4	1,07 €
9565CLR	188627-7			BHR202RFE	824861-2	163455-1	1,18 €
9565H	188627-7			BHR240	824771-3	163455-1	1,18 €
9566CR/CVR	188627-7			BHR241RFE	824771-3	163455-1	1,18 €
AF505	HY00000090			BHR261RDE/TRDE	824874-3	162271-8	1,79 €
AN450H	824792-5			BJR181RFE	824760-8	163455-1	1,18 €
AN510H	824793-3			BJS101RFE	824899-7	163455-1	1,18 €
AN610H	824490-1			BJS130RFE	824756-9	417059-4	0,16 €
AN620H	824490-1			BJV140RFE	824775-5	450909-0	0,26 €

SPONY PRE PREPRAVNÉ KUFRE

model	kufor	spóna	MOC s DPH	model	kufor	spóna	MOC s DPH
BJV180RFE	824775-5	450909-0	0,26 €	GA4530	188627-7		
BO4555/4556	824806-0			GA5030	188627-7		
BO4557	824806-0			GA7010C	824878-5	163455-1	1,18 €
BO4565/4566	824806-0			GA7020	824878-5	163455-1	1,18 €
BO5030	824562-2			GA7030	824878-5	163455-1	1,18 €
BO5031	824562-2			GA7040	824878-5	163455-1	1,18 €
BO6040	824591-5	417059-4	0,16 €	GA9010C	824878-5	163455-1	1,18 €
BPB180RFE	824766-6	163467-4	2,56 €	GA9020	824878-5	163455-1	1,18 €
BPT350RFE	824863-8			GA9020SFK	824878-5	163455-1	1,18 €
BSR730SH	153612-9	417075-6	6,49 €	GA9030	824878-5	163455-1	1,18 €
BSS500RFE	824802-8			GA9040	824878-5	163455-1	1,18 €
BSS610RFE	824757-7	163455-1	1,18 €	HG5002K	HG118897		
BTD123F	824710-3	417724-5	0,89 €	HG5012K	HG118897		
BTD130FRFE	824753-5	417724-5	0,89 €	HG550VK	HG118897		
BTD132RFE	140058-8	417724-5	0,89 €	HG551VK	HG118897		
BTD133RFE	140058-8	417724-5	0,89 €	HG650CK	HG118897		
BTD140RFE	824753-5	417724-5	0,89 €	HG651CK	HG118897		
BTD200SH	824593-1	417075-6	6,49 €	HK0500	824523-2	163455-1	1,18 €
BTL060RFE	824816-7	163455-1	1,18 €	HK1810	150640-5	417059-4	0,16 €
BTL061RFE	824816-7	163455-1	1,18 €	HK1820	824789-4	417724-5	0,89 €
BTP130RFE	824753-5	417724-5	0,89 €	HM0810	150879-0	417383-5	0,28 €
BTP140RFE	824753-5	417724-5	0,89 €	HM0810B	150878-2	162202-7	1,02 €
BTW200SH	824593-1	417075-6	6,49 €	HM0810T	150879-0	417383-5	0,28 €
BTW250RFE	824753-5	417724-5	0,89 €	HM0860C	824708-0	162202-7	1,02 €
BTW251RFE	824753-5	417724-5	0,89 €	HM0870C	824905-8		
BTW450RFE	824777-1	163467-4	2,56 €	HM0871C	824904-0		
BUC122RFE	824820-6	163455-1	1,18 €	HM1100	150676-4	416401-6	2,62 €
BVR450RFE	824768-2	417383-5	0,28 €	HM1100C	150676-4	416401-6	2,62 €
DA302D	824627-0	186347-7	1,19 €	HM1101C	140561-9		
DA312D	824627-0	186347-7	1,19 €	HM1111C	140561-9		
DA312DWAE	824627-0	186347-7	1,19 €	HM1130C	150676-4	163467-4	2,56 €
DA391DW	824627-0	186347-7	1,19 €	HM1140C	150676-4	163467-4	2,56 €
DA392D	824627-0	186347-7	1,19 €	HM1200	150583-1	163467-4	2,56 €
DA400LR	824646-6	163467-4	2,56 €	HM1200B	150586-5	163467-4	2,56 €
DA6300	181791-3			HM1200K	150583-1	163467-4	2,56 €
DA6301	181791-3			HM1202C	824564-8	163467-4	2,56 €
DBM080	P-45135			HM1203C	824876-9	162271-8	1,79 €
DBM130	P-45141			HM1213C	824908-2	162271-8	1,79 €
DF010DSE	824781-0	417724-5	0,89 €	HM1214C	824882-4	162271-8	1,79 €
DF030DWE	824842-6	417724-5	0,89 €	HM1303	182714-4		
DF330DWE	824842-6	417724-5	0,89 €	HM1303B	182851-4		
DK1150	E02248-2			HM1304	183567-4		
DK1867	824774-7	417724-5	0,89 €	HM1304B	183598-3		
DP3003	824595-7	417059-4	0,16 €	HM1307C	824898-9		
DP4001	824595-7	417059-4	0,16 €	HM1307CB	824898-9		
DP4003	824595-7	417059-4	0,16 €	HM1317C	824897-1		
DP4010	P-04101			HP1620K	824724-2		
DP4011	P-04101			HP1621K	824724-2		
DP4700	P-04101			HP1630K	824811-7	417724-5	0,89 €
FS2700	824890-5			HP1631K	824811-7	417724-5	0,89 €

Akumulátory
Odkladacie systémy
Vrtanie
Skrutkovanie
Brúsky
Pílenie
Frézovanie
Brúsenie
Klince / spony
Špeciálne stroje
Vysávanie
Fény/lampy
Záhrada
Ručné náradie
Ostatné

SPONY PRE PREPRAVNÉ KUFRE

<i>model</i>	<i>kufor</i>	<i>spona</i>	<i>MOC s DPH</i>	<i>model</i>	<i>kufor</i>	<i>spona</i>	<i>MOC s DPH</i>
HP1640K	824724-2			HR4501C	158274-8	163467-4	2,56 €
HP1641K	824724-2			HR4510C	158275-6	163467-4	2,56 €
HP1830	824650-5	417724-5	0,89 €	HR4511C	158273-0	163467-4	2,56 €
HP2030	824485-4			HR5001C	824519-3	163467-4	2,56 €
HP2031	824485-4			HR5201C	158274-8	163467-4	2,56 €
HP2050	824650-5	417724-5	0,89 €	HR5210C	158275-6	163467-4	2,56 €
HP2051	824650-5	417724-5	0,89 €	HR5211C	158273-0	163467-4	2,56 €
HP2051F	824650-5	417724-5	0,89 €	824961-8	HS300D		
HP2070	824650-5	417724-5	0,89 €	JN3200	181797-1		
HP2071	824650-5	417724-5	0,89 €	JR1000FTK	824722-6	417059-4	0,16 €
HP2071F	824650-5	417724-5	0,89 €	JR180DWD	824565-6	417152-4	1,07 €
HR160DWA	824550-9	417059-4	0,16 €	JR3000V	824539-7	417059-4	0,16 €
HR1830	824650-5	417724-5	0,89 €	JR3000VT	824539-7	417059-4	0,16 €
HR2010	824464-2	186347-7	1,19 €	JR3020	824539-7	417059-4	0,16 €
HR2020	824650-5	417724-5	0,89 €	JR3030	824539-7	417059-4	0,16 €
HR2230	824799-1	417724-5	0,89 €	JR3030T	824539-7	417059-4	0,16 €
HR2400	824445-6			JR3050T	824734-9	417724-5	0,89 €
HR2410	824445-6			JR3060T	824734-9	417724-5	0,89 €
HR2430	824575-3	417059-4	0,16 €	JR3070CT	824734-9	417724-5	0,89 €
HR2431	824575-3	417059-4	0,16 €	JS3200	181797-1		
HR2432	824729-2	163455-1	1,18 €	KP0810	824786-0		
HR2440	824650-5	417724-5	0,89 €	KP0810C	824786-0		
HR2450	824650-5	417724-5	0,89 €	LCT304	824842-6		
HR2450T	824695-3			MEU041	824888-2		
HR2460	824799-1	417724-5	0,89 €	NHP1300S	824700-6		
HR2470	824799-1	417724-5	0,89 €	PC1100	181789-0		
HR2470T	824799-1	417724-5	0,89 €	PC5000C	140073-2		
HR2600	141856-3	162302-3	0,99 €	SC130DRA	SC08100910		
HR2650/2651	141856-3	162302-3	0,99 €	SG1250	824709-8	163455-1	1,18 €
HR2800	824789-4	417724-5	0,89 €	SG150	B50856		
HR2810	824789-4	417724-5	0,89 €	SKR60	LM.400.02		
HR2810T	824789-4	417724-5	0,89 €	SKR301	ZA.023.0M		
HR2811F	824789-4	417724-5	0,89 €	SP6000K	824783-6		
HR2811FT	824789-4	417724-5	0,89 €	T221DW	183771-5		
HR3000C	824559-1	163467-4	2,56 €	TD020DSE	831272-4		
HR3200C	824819-1	163467-4	2,56 €	TD090DWE	824842-6	417724-5	0,89 €
HR3210C	824825-6	163467-4	2,56 €	TW0200	824703-0	186347-7	1,19 €
HR3210FCT	824825-6	163467-4	2,56 €	TW0350	824702-2	186347-7	1,19 €
HR3520	150597-0	163467-4	2,56 €	TW1000	824737-3	416401-6	2,62 €
HR3540C	824819-1	163467-4	2,56 €	UC120DWAE	824491-9	417059-4	0,16 €
HR3541FC	824819-1	163467-4	2,56 €	VR250DWAE	824486-2		
HR3550C	824559-1	163467-4	2,56 €	VR250DWDE	824486-2		
HR3850	150582-3	163467-4	2,56 €				
HR3850K	150582-3	163467-4	2,56 €				
HR4000C	824479-9	416401-6	2,62 €				
HR4001C	158693-8	163467-4	2,56 €				
HR4002	824798-3	163467-4	2,56 €				
HR4010C	158691-2	163467-4	2,56 €				
HR4011C	158692-0	163467-4	2,56 €				
HR4500C	824607-6	163467-4	2,56 €				

model	obj. číslo	model	obj. číslo	model	obj. číslo	model	obj. číslo	model	obj. číslo
440	80051B5X*	6510LVR	CB-64	BCS550	CB-430	BFT125FZ	CB-434	BTP141	CB-448
445X	80050B0X*	6821	CB-419	BDA340	CB-448	BFT126FZ	CB-434	BTS130	CB-448
446L	W49625*	6822	CB-419	BDA341	CB-448	BGA450	CB-430	BTW200	CB-441
447L	W49625*	6823	CB-419	BDA350	CB-448	BGA452	CB-430	BTW250	CB-448
448	80051B5X*	6824	CB-419	BDA351	CB-448	BGD800	CB-430	BTW251	CB-448
906	CB-64	6825R	CB-419	BDF440	CB-448	BHP440	CB-448	BTW450	CB-441
1806B	CB-153	6826	CB-419	BDF441	CB-448	BHP441	CB-448	BUB360	CB-430
1902	CB-51	6827	CB-419	BDF442	CB-448	BHP442	CB-448	BUC122	CB-430
1911B	CB-106	6842	CB-411	BDF444	CB-448	BHP444	CB-448	BUC250	CB-442
1923H	CB-132	6844	CB-411	BDF446	CB-448	BHP446	CB-448	BUH550	CB-442
2012NB	CB-153	6904VH	CB-415	BDF448	CB-448	BHP448	CB-448	CA5000	CB-303
2107FK	CB-303	6905B	CB-65	BDF450	CB-448	BHP450	CB-448	DA3010F	CB-419
2414EN	CB-203	6905H	CB-415	BDF451	CB-448	BHP451	CB-448	DA3011F	CB-419
2414NB	CB-203	6906	CB-100	BDF452	CB-448	BHP452	CB-448	DA4000LR	CB-303
2704	CB-153	6916FD	CB-431	BDF454	CB-448	BHP454	CB-448	DA6301	CB-100
3612C	CB-203	6918FD	CB-434	BDF456	CB-448	BHP456	CB-448	DBM080	EE7332022S**
3612	CB-203	6934FD	CB-434	BDF458	CB-448	BHP458	CB-448	DBM130	EE7332022S**
3620	CB-106	6935FD	CB-434	BFL060FZ	CB-434	BHR162	CB-430	DBM230	EE7332022S**
3706	CB-64	6936FD	CB-434	BFL061FZ	CB-434	BHR200	CB-430	DBN500	CB-448
3707	CB-411	6951	CB-411	BFL080FZ	CB-434	BHR202	CB-441	DCO180	CB-430
3708	CB-411	6953	CB-411	BFL081FZ	CB-434	BHR240	CB-430	DCS550	CB-430
3709	CB-411	6980FD	CB-434	BFL082FZ	CB-434	BHR241	CB-441	DDA340	CB-448
3710	CB-411	7104L	CB-153	BFL120FZ	CB-434	BHR261	CB-442	DDA341	CB-448
3901	CB-411	8414D	CB-430	BFL122FZ	CB-434	BHR262	CB-442	DDA350	CB-448
4101RH	CB-303	8434D	CB-430	BFL200FZ	CB-434	BHS630	CB-441	DDA351	CB-448
4105KB	CB-100	8444D	CB-430	BFL201FZ	CB-434	BJN161	CB-430	DDF446	CB-448
4112HS	CB-204	9031	CB-411	BFL201RZ	CB-434	BJR181	CB-411	DDF448	CB-448
4131	CB-303	9032	CB-411	BFL202FZ	CB-434	BJS101	CB-430	DDF456	CB-448
4157KB	CB-153	9046	CB-419	BFL300FZ	CB-434	BJS130	CB-448	DDF458	CB-448
4326	CB-64	9079SF	CB-204	BFL301FZ	CB-434	BJV140	CB-430	DDF482	CB-448
4327	CB-64	9207SPB	CB-100	BFL301RZ	CB-434	BJV180	CB-430	DFR440	CB-448
4329	CB-64	9227CB	CB-303	BFL400FZ	CB-434	BKP180	CB-441	DFR540	CB-448
4350	CB-419	9237CB	CB-303	BFL402FZ	CB-434	BLS713	CB-441	DFR550	CB-448
4351	CB-419	9403	CB-303	BFL402RZ	CB-434	BO3700	CB-64	DFR750	CB-448
5014/5016	CB-403	9404	CB-303	BFR440	CB-448	BO3710	CB-64	DFS440	CB-448
5017RKB	CB-303	9541/9542	CB-302	BFR540	CB-448	BO3711	CB-64	DFS450	CB-448
5103R	CB-203	9554/55NB	CB-325	BFR550	CB-448	BO4555	CB-419	DFS451	CB-448
5104S	CB-203	9557/58	CB-325	BFR750	CB-448	BO4556	CB-419	DGA450	CB-430
5143R	CB-203	9562CH/CVH	CB-318	BFS440	CB-448	BO4557	CB-419	DGA452	CB-430
5603R	CB-303	9562CR	CB-318	BFS441	CB-448	BO4565	CB-419	DGD800	CB-430
5604R	CB-303	9562CVH	CB-318	BFS450	CB-448	BO4900V	CB-419	DHP446	CB-448
5704R	CB-303	9562CVR	CB-318	BFS451	CB-448	BO5021	CB-64	DHP448	CB-448
5705R	CB-303	9564H	CB-325	BFT020FZ	CB-434	BO5030	CB-419	DHP456	CB-448
5903R	CB-203	9565C/CV	CB-318	BFT022FZ	CB-434	BO5031	CB-419	DHP458	CB-448
6013B	CB-51	9565CLR	CB-318	BFT040FZ	CB-434	BO5041	CB-64	DHP482	CB-448
6207D	CB-430	9565CR	CB-318	BFT041FZ	CB-434	BO6030	CB-419	DHR162	CB-430
6300-4	CB-51	9565CVL	CB-318	BFT041RZ	CB-434	BO6040	CB-318	DHR164	CB-430
6305	CB-303	9565CVR	CB-318	BFT042FZ	CB-434	BO6050	CB-325	DHR165	CB-430
6317D	CB-430	9565H	CB-325	BFT043FZ	CB-434	BPB180	CB-430	DHR202	CB-441
6319D	CB-430	9565HZ1	CB-325	BFT044FZ	CB-434	BPJ180	CB-430	DHR241	CB-441
6337D	CB-430	9565PCV	CB-318	BFT080FZ	CB-434	BSS500	CB-430	DHR263	CB-442
6339D	CB-430	9566C/CV	CB-318	BFT082FZ	CB-434	BSS501	CB-430	DHR264	CB-442
6347D	CB-430	9566CR	CB-318	BFT082RZ	CB-434	BSS610	CB-411	DHS630	CB-441
6349D	CB-430	9566CVR	CB-318	BFT083FZ	CB-434	BTD130	CB-448	DHS710	CB-442
6408	CB-419	9741	CB-100	BFT084FZ	CB-434	BTD134	CB-448	DJN161	CB-430
6412	CB-64	9903	CB-303	BFT122FZ	CB-434	BTD140	CB-448	DJR181	CB-411
6413	CB-64	9910/11	CB-411	BFT123FZ	CB-434	BTD146	CB-448	DJS101	CB-430
6501X	CB-70	9920	CB-303	BFT124FZ	CB-434	BTP130	CB-448	DJS130	CB-448
6501	CB-70	9924DB	CB-100	BFT124RZ	CB-434	BTP140	CB-448	DJV140	CB-430

Akumulátory
 Odkladacie systémy
 Vrtanie
 Skrutkovanie
 Brúsky
 Pílenie
 Frézovanie
 Brúsenie
 Klince / spony
 Špeciálne stroje
 Vysávanie
 Fény/lampy
 Záhrada
 Ručné náradie
 Ostatné

model	obj. číslo	model	obj. číslo	model	obj. číslo	model	obj. číslo	model	obj. číslo
DJV180	CB-430	GA7061R	CB-218	HP2050	CB-419	JS1660	CB-65	TM3010C	CB-459
DKP180	CB-441	GA7062R	CB-218	HP2051	CB-419	JS1670	CB-65	TW0200	CB-411
DLS713	CB-441	GA7063R	CB-218	HP2070	CB-419	JS3200	CB-100	TW0350	CB-411
DP2010	CB-419	GA7070/7071	191T31-1	HP2071	CB-419	JS3201	CB-303	TW1000	CB-153
DP2011	CB-419	GA9010	CB-204	HR1830	CB-419	JV0600	CB-64	UB1101	CB-303
DP3003	CB-419	GA9020	CB-204	HR2010	CB-105	KC100	CB-203	UB1103	CB-303
DP4001	CB-419	GA9030	CB-204	HR2230	CB-325	KP0800	CB-411	UB360D	CB430
DP4003	CB-419	GA9040	CB-204	HR2300	CB-325	KP0810	CB-132	UC250D	CB442
DP4010	CB-419	GA9050	CB-204	HR2432	CB-419	KP0810C	CB-132	UC3020A	CB-132
DP4011	CB-419	GA9060R	CB-218	HR2450	CB-419	KP312S	CB-203	UC3030A	181044-0*
DP4700	CB-64	GA9061R	CB-218	HR2460	CB-325	LC1230	CB-203	UC3041A	CB-132
DPB180	CB-430	GA9062R	CB-218	HR2470	CB-325	LF1000	CB-153	UC3051A	CB-153
DPJ180	CB-430	GA9063R	CB-218	HR2600	CB-325	LH1040	CB-153	UC3520A	CB-132
DS4010	CB-411	GA9070/9071	191T31-2	HR2610	CB-325	LH1200FL	JM23300083*	UC3530A	181044-0*
DS4011	CB-411	GD0600	CB-325	HR2611	CB-325	LH1201FL	JM23000123*	UC3541A	CB-132
DSC191	CB-448	GD0601	CB-325	HR2630	CB-325	LS0714	CB-303	UC3551A	CB-153
DSS500	CB-430	GD0602	CB-325	HR2630T	CB-325	LS0714FL	CB-303	UC4020A	CB-132
DSS610	CB-411	GD0603	CB-64	HR2631F	CB-325	LS0815FL	JM23500117	UC4030A	181044-0*
DTD134	CB-448	GD0800C	CB-318	HR2631FT	CB-325	LS1013	CB-153	UC4041A	CB-132
DTD146	CB-448	GD0801C	CB-318	HR2641	CB-325	LS1013L	CB-153	UC4051A	CB-153
DTD152	CB-448	GD0810C	CB-318	HR2800	CB-325	LS1016	CB-153	UC4530A	181044-0*
DTP141	CB-448	GD0811C	CB-318	HR2810	CB-325	LS1016L	CB-153	UC4551A	CB-153
DTS130	CB-448	HB500	EIB106C*	HR2811F	CB-325	LS1018L	JM23000123*	UH4260	CB-419
DTW250	CB-448	HK0500	CB-113	HR2811FT	CB-325	LS1040	CB-153	UH4261	CB-419
DTW251	CB-448	HK1820	CB-350	HR3200C	CB-350	LS1214	CB-153	UH4570	CB-419
DTW450	CB-441	HK1820L	CB-350	HR3210C	CB-350	LS1214L	CB-153	UH4860	CB-419
DUB361	CB-430	HM0810T	CB-105	HR3210FCT	CB-350	LS1216	CB-153	UH4861	CB-419
DUC122	CB-430	HM0860C	CB-327	HR3540C	CB-350	LS1216L	CB-153	UH5260	CB-419
DVC860L	CB-353	HM0870C	CB-350	HR3541FC	CB-350	LS1440	CB-154	UH5261	CB-419
FS2300	CB-419	HM0871C	CB-350	HR4001C	CB-350	LW1400	CB-203	UH550D	CB442
FS2700	CB-419	HM1101C	CB-175	HR4002	CB-350	LW1401	CB-203	UH5540	223804410*
FS4000	CB-419	HM1111C	CB-175	HR4003C	CB-175	M6001/6002	CB-85	UH5550	957800410*
FS4300	CB-419	HM1200	CB-155	HR4011C	CB-350	M8100/8001	CB-85	UH5570	CB-419
FS6300R	CB-419	HM1200B	CB-155	HR4013C	CB-175	M8103/8104	CB-85	UH5580	CB-419
GA4530	CB-459	HM1202C	CB-155	HR4501C	CB-175	MLS100	JM23000123*	UH6350	957800410*
GA4530R	CB-459	HM1203C	CB-175	HR4510C	CB-175	MLT100X	JM23000123*	UH6540	223804410*
GA4540	CB-325	HM1205C	CB-175	HR4511C	CB-175	N1923B	CB-51	UH6570	CB-419
GA4540C01	CB-325	HM1213C	CB-175	HR5201C	CB-175	N5900B	CB-153	UH6580	CB-419
GA4540R	CB-325	HM1214C	CB-175	HR5202C	CB-175	PC1100	CB-100	UH7580	CB-419
GA4541C01	CB-325	HM1304	CB-204	HR5210C	CB-175	PC5000C	CB-253	UR3500	YA00000504*
GA4541R	CB-325	HM1304B	CB-204	HR5211C	CB-175	PC5001C	CB-253	UR3501	YA00000504*
GA4541X01	CB-325	HM1307C	CB-175	HR5212C	CB-175	PJ7000	CB-459	UT120	EE80700013**
GA5021	CB-303	HM1307CB	CB-175	HS6100/6101	CB-174	PV7000C	CB-303	UT1200	EE80700032
GA5030	CB-459	HM1317C	CB-175	HS7100/7101	CB-174	PW5000CH	CB-318	UT1305	CB-303
GA5030R	CB-459	HM1400	CB-155	HS6101	CB-147	RP0900	CB-107	UT1400	EE80700013**
GA5040	CB-325	HM1501	CB-218	HS7101	CB-147	RP0910	CB-303	UT1401	EE80700013**
GA5040C01	CB-325	HM1502	CB-218	HS7601	CB-303	RP1110C	CB-303	UT1600	EE7332022S**
GA5040R	CB-325	HM1511	CB-218	JN1601	CB-411	RP1800FX	CB-203	UT2204	CB-303
GA5041C01	CB-325	HM1512	CB-218	JN3200	CB-100	RP2300FCX	CB-203	VC2211	CB-173
GA5041R	CB-325	HM1801	CB-204	JN3201	CB-303	RT0700C	CB-411	VC3210	CB-173
GA5041X01	CB-325	HM1802	CB-218	JR1000FTK	CB-419	SA5040C	CB-318	VC3211	CB-173
GA5050/5051R	CB-260	HM1810	CB-204	JR180DWDE	CB-432	SA7000C	CB-204		
GA6021	CB-303	HM1812	CB-218	JR3050T	CB-303	SG1250	CB-318		
GA6040C01	CB-325	HP1620	CB-419	JR3060T	CB-303	SG1251J	CB-318		
GA7010C	CB-204	HP1621	CB-419	JR3070CT	CB-303	SG150	B45872**		
GA7020	CB-204	HP1630	CB-85	JS1000	CB-459	SP6000	CB-303		
GA7030	CB-204	HP1631	CB-85	JS1600	CB-65	SP6000K	CB-303		
GA7040	CB-204	HP1640	CB-419	JS1601	CB-459	TD0101F	CB-411		
GA7060R	CB-218	HP1641	CB-419	JS1602	CB-459	TM3000C	CB-459		

* zároveň obj. číslo; ** zároveň obj. číslo, iba 1 ks v balení

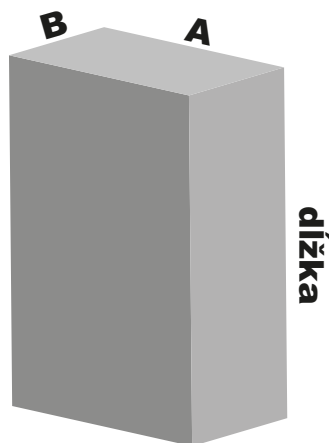

typ	obj. č.	dĺžka	šírka A	hĺbka B	MOC s DPH
CB-51	181021-2	11,8	8	5	2,29 €
CB-55	181026-2	11,7	8	5	3,59 €
CB-64	191627-8	10,8	8	5	2,39 €
CB-65	191628-6	11,7	8	5	3,59 €
CB-70	191914-5	10,8	8	5	2,99 €
CB-85	191998-3	k.A.	k.A.	k.A.	2,49 €
CB-100	181030-1	14,8	10	6	2,49 €
CB-105	181038-5	15,3	9,9	5,9	7,79 €
CB-106	181410-1	14,8	10	6	3,29 €
CB-113	191904-8	14,8	9,9	6	8,09 €
CB-132	191972-1	14,7	10	6	3,99 €
CB-153	181044-0	17,8	13,4	6,5	2,69 €
CB-154	181047-4	17,8	13,4	6,5	4,49 €
CB-155	181048-2	17,8	13,4	6,5	7,19 €
CB-173	195483-8	k.A.	k.A.	k.A.	9,09 €
CB-174	196018-8	k.A.	k.A.	k.A.	5,09 €
CB-175	195844-2	26,6	8,4	6,5	5,09 €
CB-203	191953-5	15,8	17,9	6,9	3,49 €
CB-204	191957-7	16,2	17,9	7	4,29 €
CB-218	197129-2	23,7	17,9	6,9	5,49 €
CB-251	194547-5	16,8	10,9	6,9	4,19 €
CB-253	194547-5	16,8	10,9	6,9	4,19 €
CB-260	191D85-2	k.A.	k.A.	k.A.	6,39 €
CB-302	191959-3	k.A.	k.A.	k.A.	6,99 €
CB-303	191963-2	17,8	10,9	5	2,79 €
CB-318	191978-9	15,7	10,9	5	8,49 €
CB-325	194074-2	15,8	11	4,9	1,69 €
CB-327	194285-9	16,8	11	4,9	6,29 €
CB-350	194160-9	25,3	10,9	6,5	5,59 €
CB-353	197208-6	k.A.	k.A.	k.A.	27,99 €
CB-403	191928-4	k.A.	k.A.	k.A.	6,49 €
CB-411	191940-4	11,7	8,9	6	3,29 €
CB-414	191949-6	11,6	5,7	3,7	4,39 €
CB-415	191950-1	8,7	8,9	6	4,99 €
CB-417	191955-1	9,4	8,9	6	9,19 €
CB-419	191962-4	11,3	9	6	2,89 €
CB-424	191966-6	8,7	5,3	4,8	2,99 €
CB-430	191971-3	9,7	7,2	6,9	3,29 €
CB-434	193466-2	11,8	5,8	4,9	3,39 €
CB-441	194435-6	10,8	10,8	6,9	4,69 €
CB-442	194928-3	10,8	10,7	6,9	3,79 €
CB-448	196854-2	13,3	9,9	3	3,59 €
CB-459	194722-3	12,8	8,9	6	2,49 €
	191T31-1	k.A.	k.A.	k.A.	4,29 €
B45872 (iba 1 ks)		20	9,9	6,2	12,89 €
EE7132A22S (iba 2 ks)		17,9	9,9	6,2	24,19 €
EE7332022S (iba 2 ks)		20	15,9	6,2	22,49 €
EIB106C		k.A.	k.A.	k.A.	37,09 €
JM23000123		17,3	13,4	6,5	3,59 €
W49625		32	10,9	6,3	52,39 €
JM23500117		k.A.	k.A.	k.A.	3,19 €
EE7701822S		k.A.	k.A.	k.A.	23,59 €
YA00000504		k.A.	k.A.	k.A.	0,79 €

VYSVETLIVKY

18 V / 12 V MAX program

- Z – dodávané bez akumulátora a nabíjačky
- J – dodávané v systainery
- K – dodávané v kufri
- X – extra príbal príslušenstva
- PT2 – Dvojnabíjačka /rýchlonabíjačka/, 2 ks 5,0 Ah akumulátor
- PT4 – Dvojnabíjačka /rýchlonabíjačka/, 4 ks 5,0 Ah akumulátor
- PF2 – Rýchlonabíjačka, 2 ks 3,0 Ah akumulátor
- RF – Rýchlonabíjačka, 1 ks 3,0 Ah akumulátor
- SYE – Nabíjačka, 2 ks 1,5 Ah akumulátor
- RFJ – Rýchlonabíjačka, 2 ks 3,0 Ah akumulátor, systainer
- RFE – Rýchlonabíjačka, 2 ks 3,0 Ah akumulátor
- RTE – Rýchlonabíjačka, 2 ks 5,0 Ah akumulátor
- RTJ – Rýchlonabíjačka, 2 ks 5,0 Ah akumulátor, systainer
- RF3J – Rýchlonabíjačka, 3 ks 3,0 Ah akumulátor, systainer
- RFEb – Rýchlonabíjačka, 2 ks 3,0 Ah akumulátor, čierne prevedenie stroja
- RTJV – Rýchlonabíjačka, 2 ks 5,0 Ah akumulátor, systainer, odsávacie zariadenie
- DZ – dodávané bez akumulátora a nabíjačky
- DSAE – Rýchlonabíjačka, 2 ks 2,0 Ah akumulátor
- DSME – Rýchlonabíjačka, 2 ks 4,0 Ah akumulátor

40 V program

- GD101 – Rýchlonabíjačka, 1 ks 2,5 Ah akumulátor
- GM101 – Rýchlonabíjačka, 1 ks 4,0 Ah akumulátor
- GT101 – Rýchlonabíjačka, 1 ks 5,0 Ah akumulátor
- GZ – dodávané bez akumulátora a nabíjačky
- GD201 – Rýchlonabíjačka, 2 ks 2,5 Ah akumulátor
- GM201 – Rýchlonabíjačka, 2 ks 4,0 Ah akumulátor
- GT201 – Rýchlonabíjačka, 2 ks 5,0 Ah akumulátor

Označenie akumulátorov 12 / 14,4 / 18 V

- Y – 1,5 Ah
- A – 2,0 Ah
- F – 3,0 Ah
- M – 4,0 Ah
- T – 5,0 Ah
- G – 6,0 Ah



- A – 2,0 Ah
- D – 2,5 Ah
- M – 4,0 Ah
- T – 5,0 Ah

ADT – Automatická regulácia otáčok

AFT – Automatické zastavenie stroja

DXT – presný rez

XPT – ochrana proti zvýšenej
prašnosti a vlhkosti

SJST – antivibračný systém

AWS – prepojenie aku strojov
s aku vysávačom

AVT – antivibračný systém

ANTI VIBRATION TECHNOLOGY

BL – bezuhlíkový motor

MOTOR



– brzda

Sortiment príslušenstva

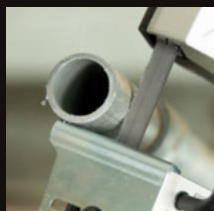

Spoločnosť Makita si vyhradzuje právo kedykoľvek vykonávať zmeny ponuky bez predchádzajúceho upozornenia.
Ponuky sú k dispozícii do vypredania skladových zásob.
Obrázky sú ilustračné a oproti skutočnosti sa môžu líšiť.



Makita s. r. o.
Priemyselná 26
974 01 Banská Bystrica
Web: www.makita.sk

Uvedené ceny sú odporúčané maloobchodné ceny vrátane DPH. Technické údaje sú nezáväznú. Výrobca nie je zodpovedný za tlačové chyby.