

Installieren *Install*
Montieren *Mount*
Reparieren *Repair*

 **RENNSTEIG**
Solutions for professionals.

Werkzeuglösungen *Tool solutions*

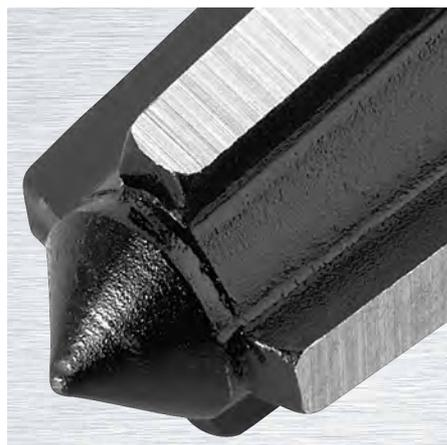
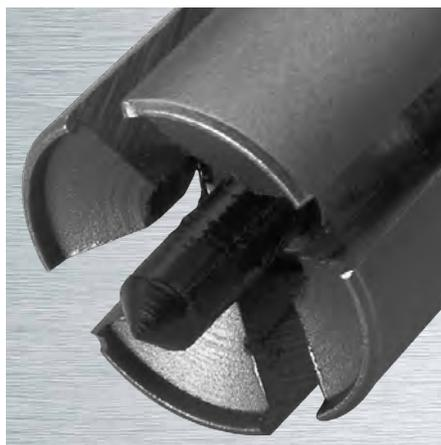
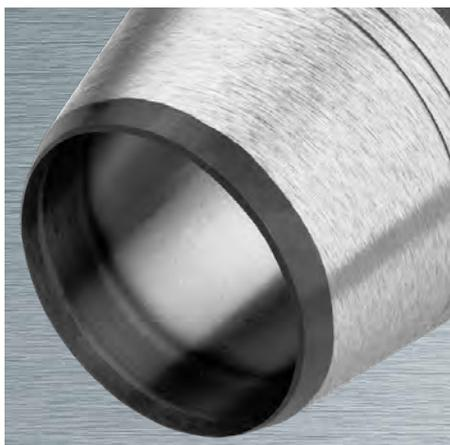
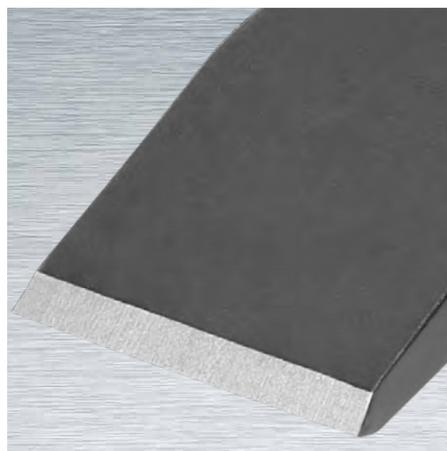
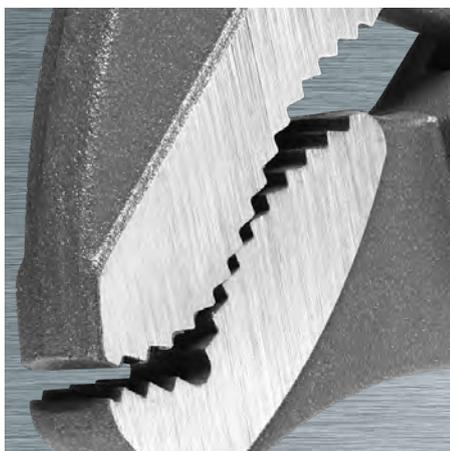

RENNSTEIG – Lösungen für Profis

**RENNSTEIG –
*Solutions for professionals***



Hauptsitz Viernau
Headquarter Viernau



Werkzeuglösungen Tool solutions

Die Firma RENNSTEIG verdankt ihren Namen dem „Rennsteig“, einem der schönsten Mittelgebirgswanderwege Deutschlands. Unser Firmensitz befindet sich in Thüringen, einer Region mit Jahrhunderte alter Tradition in der Werkzeugherstellung.

Immer eine gute Verbindung – nach dieser Überzeugung entstehen bei RENNSTEIG seit 1959 Profi-Handwerkzeuge von der Idee bis zum Serienprodukt.

Seit 1991 agiert RENNSTEIG als eigenständige Tochter der renommierten KNIPEX-Werk C. Gustav Putsch KG in Wuppertal.

The company RENNSTEIG owes its name to one of the most beautiful hiking trails of Germany - The "Rennsteig". Our headquarters is located in Thuringia, a region with a longstanding tradition of excellence in hand tool design and manufacturing.

Always a good connection – since 1959, RENNSTEIG has been making the professional tools for the job, from the idea to series production.

Since 1991 RENNSTEIG has been an independent subsidiary of the well-known tool maker KNIPEX-Werk C. Gustav Putsch KG in Wuppertal, Germany.



Betriebsteil Altersbach
Manufacturing Site Altersbach

Tradition am Puls der Zeit

A tradition of leadership

Mit neuen Technologien und Arbeitsverfahren werden hochwertige Materialien zu Werkzeugen der Kabelbearbeitung, Kabelscheren, Abisolier- und Kabelcrimpzangen, Schlagwerkzeugen, Einsteckwerkzeugen sowie zu einem breiten Sortiment an sonstigen Werkzeugen verarbeitet.

Eine eigene Entwicklungsabteilung ermöglicht zahlreiche Neu- und Weiterentwicklungen. Eine Reihe von Patenten, auch über die Grenzen Deutschlands hinaus, dokumentieren die Innovationsfähigkeit des Unternehmens. So können auch kundenspezifische Sonderzangen für die verschiedensten Anwendungsgebiete entwickelt und gebaut werden.

Using new technologies, innovative processes and the highest quality materials, we build cable cutting, stripping and crimping tools, striking tools, shank chisels and a wide variety of other tools.

Our in-house R&D Department works to continuously improve our tools and develop new ones, and numerous international patents are evidence of our innovative ability. One of our special strengths is the development and manufacturing of customer-specific plier designs for a very diverse array of special tasks.



DIN
Norm



Automatisierte Fertigung von Rohrzangen, Nageleisen und Meißeln
Automated production of pipe wrenches, crowbars and chisels



Ihr kompetenter Partner

Your expert partner

RENNSTEIG Qualitätswerkzeuge werden regelmäßig auf den wichtigsten internationalen Branchenmessen präsentiert. Das Unternehmen genießt beim Fachpublikum einen ausgezeichneten Ruf und hat weltweit einen festen Stellenwert unter den renommierten Werkzeugherstellern.

Die erfolgreiche Zertifizierung nach ISO 9001 zeigt eindrucksvoll die hervorragende Einstellung und das positive Verhältnis aller Mitarbeiter des Unternehmens zu Fragen der Qualität – ein Erfolgsfaktor für die Präsenz der RENNSTEIG Werkzeuge auf dem sehr sensiblen Werkzeugmarkt für jetzt und die Zukunft.

Durch die GFE - Gesellschaft für Fertigungstechnik und Entwicklung Schmalkalden e.V. - wurde einer Vielzahl von RENNSTEIG Werkzeugen das Gütesiegel erteilt und somit die Fertigung nach DIN bestätigt.

RENNSTEIG's high-quality tools are regularly presented at the leading international tool shows; and we enjoy an excellent reputation amongst knowledgeable professionals. Around the world, experts know RENNSTEIG as one of the top tool manufacturers.

Our ISO 9001 certification demonstrates the proactive approach and the positive engagement of all employees of the company on the issue of quality - a critical success factor for the presence of RENNSTEIG tools on the highly sensitive tool market - now and in the future.

The GFE, the Association for Product Engineering and Development Schmalkalden e.V., has awarded numerous RENNSTEIG tools with a Quality Seal and has certified the production according to DIN standards.



Auf internationalen Fachmessen stellt sich RENNSTEIG dem kritischen Fachpublikum
RENNSTEIG presents its tools to professional users at international trade fairs



Inhaltsverzeichnis *Contents*

Sanitärwerkzeuge

Rohrzangen, Sets

Kombischeren, Rohrscheren, Ratschenscheren

Sanitärkreuzschlüssel

Plumbing Tools

Pipe Wrenches, Sets

Pipe Cutters, Ratchet Pipe Cutters

Plumbing Wrenches



8–19

10–13

14–19

17

Spezialwerkzeuge

Henkellocheisen, Revolverlochzangen

Sicherungsringwerkzeuge

Ausklinkzangen, Pelikanschere

Gripzangen

Special Tools

Wad Punches, Revolving Punch Pliers

Circlip Pliers

Notching Pliers, Pelican Cutters

Locking Pliers



20–35

22–25

26–27

28–31

32–35

Werkzeuge für den Metallbereich

Splintentreiber, Durchtreiber, Körner

Meißel, Verkaufsdiskontrollen

Schaber, Lösehebel

Schraubenausdreher

Metalworking Tools

Parallel Pin Punches, Taper Punches, Centre Punches

Chisels, Sales Displays

Scrapers, Release Lever

Screw Extractors



36–61

38–49

50–55

56–59

60–61

Werkzeuge für den Bau- und Montagebereich

Meißel, Verkaufsdiskontrollen

Nageleisen, Brechstangen, Dorne, Einschlaghilfen

Tools for Construction and Installation

Chisels, Sales Displays

Wrecking Bars, Crowbars, Plugs, Impact Nail Set



62–75

64–69

70–75

Meißel für Elektro- und Druckluftschlämmer

Meißel für Elektroschlämmer

Meißel für Elektro- und Druckluftschlämmer

Meißel für Druckluftschlämmer

Meißel XXL

Shank Chisels for Electric and Pneumatic Hammers

Shank Chisels for Electric Hammers

Shank Chisels for Electric and Pneumatic Hammers

Shank Chisels for Pneumatic Hammers

XXL Chisels



76–89

80–85

85

86–87

88–89

Weitere Informationen

Additional Information

90–91

Ohne unsere Genehmigung ist es nicht gestattet, den Katalog oder Teile daraus in jeglicher Form zu vervielfältigen. Änderungen vorbehalten. Keine Gewährleistung für Druckfehler und Irrtümer.

It is not permissible to copy the catalogue or parts of it in any way without our approval. Subject to change without notice. No liability is assumed for misprints or errors.

Investition in die Zukunft: Sanitärwerkzeuge von RENNSTEIG.

Ob im privaten oder öffentlichen Bereich: Sanitärtechnik dient der Hygiene und damit unserer Gesundheit. Technische Installationen für die Wasserver- und Entsorgung gehören ebenso wie Heizungs- und Lüftungsanlagen zu diesem Bereich.

Die Installation sanitärer Anlagen ist eine Investition in die Zukunft des Gebäudes und stellt einen nicht zu unterschätzenden Kostenfaktor dar. Umso wichtiger ist die korrekte Installation, sie sichert die störungsfreie Nutzung über viele Jahre. Gerade für sanitärtechnische Arbeiten sind die richtigen Werkzeuge entscheidend, die natürlich auch sach- und fachgerecht zum Einsatz kommen müssen.

Flüssigkeiten und Gase werden in Gebäuden vor allem in Rohrleitungen transportiert. Die Hersteller der Rohre entwickeln Materialien und Konzepte ständig weiter, um neue Anforderungen zu erfüllen. Neben den bekannten, klassischen Rohren aus Stahl und Kupfer setzt man heute neue, moderne und leistungsfähigere Materialien, wie etwa Mehrschichtverbundrohrsysteme ein.

Passende Werkzeuge spielen eine wesentliche Rolle bei der richtigen Bearbeitung dieser Systeme. Dies gilt beispielhaft für die klassische Bearbeitung eines Stahlrohrs mit einer sicheren, GS-geprüften Rohrzange oder das schonende Verschrauben hochwertiger Armaturen. Ebenso ist das exakte, verformungsarme und rechtwinklige Schneiden eines Mehrschichtverbundrohres und dessen präzise Kalibrierung vor der weiteren Verarbeitung nur mit hochwertigen Qualitätswerkzeugen möglich.

RENNSTEIG bietet Ihnen eine Vielzahl von Werkzeugen an, die universell einsetzbar oder speziell auf Ihre Anwendung hin optimiert sind. Alle Werkzeuge werden professionell geprüft und beweisen im täglichen Einsatz ihre Leistungsfähigkeit. Sie bestehen aus hochwertigen, zum Teil spezialvergüteten Hochleistungswerkstoffen, und entsprechen den für den jeweiligen Einsatzfall geltenden Normen und Vorschriften, oder sie übertreffen diese sogar.

An investment in the future: RENNSTEIG Plumbing Tools

Whether in private homes or public buildings, plumbing is essential for sanitation and health. This goes beyond water supply and disposal; it includes heating and ventilation technology as well.

Installing plumbing is an investment in the future of a building, as well as a significant cost factor. This makes proper installation important to ensure many years of worry-free use. This in turn requires professional skills and the right tools.

Pipes transport liquids and gases throughout buildings. Pipe manufacturers are continually improve their materials and designs to meet new requirements. Today, in addition to the familiar steel and copper pipes, new high-performance materials, such as multilayer composites, are used.

All these pipe materials and types require the right tools for proper installation and repair. For conventional metal pipe or for installing high-end fittings without leaving marks, GS-approved pipe wrenches are the right choice. Other specialized tools are needed for cutting multilayer composite pipes precisely, at a 90° angle and with minimum deformation so they are ready for further processing.

RENNSTEIG offers a wide range of general purpose tools, as well as for specialized use. All are professionally inspected and prove their value in use day in and day out. Made of high quality materials, in many cases with special coatings, the tools meet and often exceed the standards and requirements for their applications.

Sanitärwerkzeuge *Plumbing Tools*



Schnell, präzise und
kraftvoll zupacken
*For a fast, precise,
powerful grip*

patentiert
patented



Art. No. 1302 015 2



Passgenaue Einstellung direkt am Werkstück

*Adjusts for a perfect fit without removal
from the workpiece*



Schnelle und präzise Verstellung per Knopfdruck

Quick and precise adjustment by pushbutton



Sichere Anpassung auf gesamten Arbeitsbereich

*Safe locking and gripping for the complete working
range*

Rohrzange S-Maul mit Schnellverstellung

- zeitsparende präzise Schnellverstellung
- Einhandbedienung
- Einstellung der Öffnungsweite per Knopfdruck direkt am Werkstück
- kein unbeabsichtigtes Verstellen der Zangenschenkel
- hohe Kraftübertragung durch vollvergütete Zangenschenkel
- integrierter Klemmschutz zur Vermeidung von Quetschungen
- zweifarbig pulverlackiert mit kunststoffbeschichteten Griffhüllen



Art. No. 1302 015 2



Hohe Verschleißfestigkeit durch zusätzlich gehärtete Verzahnung

Teeth specially hardened for high wear resistance

Pipe Wrench, S-jaws with quick adjustment

- Time-saving and precise quick adjustment
- One-hand operation
- Adjustment of opening width by pushbutton without leaving the workpiece
- No unintentional shifting of the jaws
- Maximum force transmission with drop forged and hardened handles
- Integral crush protection
- Powder coated in two colors with plastic grips



Art. No.	Zoll Inch	Griffe Grips	mm	Länge Length mm	Gewicht Weight g	VPE PU	 DIN 5234
1302 010 2	1	•	0-42	325	930	1	•
1302 015 2	1 1/2	•	0-60	425	1560	1	•
1302 020 2	2	•	0-70	560	2420	1	•



Kraftsparendes Arbeiten durch Selbstklemmung

Self-clamping mechanism for convenient handling

RENNSTEIG Rohrzangen

- Alle Zangen aus Chrom-Vanadium-Stahl, geschmiedet und vergütet
- Verzahnung induktiv gehärtet
- gegen die Drehrichtung versetzte Verzahnung
- schlankes Mauldesign für bessere Zugänglichkeit
- Zangenhebel aus Doppel-T-Profil, verstärkte Führungshülse
- Stellmutternsicherung, Klemmschutz
- zweifarbig pulverlackiert
- Zangenspiegel geschliffen

RENNSTEIG Eckrohrzange Zangenmaul „S“-Form

- 45° abgewinkeltes Zangenmaul „S“-Form, Form C



Art. No. 131 010 2



RENNSTEIG Eckrohrzange Zangenmaul 45°

- 45° abgewinkeltes Zangenmaul, Form B



Art. No. 121 010 2



RENNSTEIG Rohrzange Zangenmaul 90°

- 90° abgewinkeltes Zangenmaul, Form A



Art. No. 111 010 2

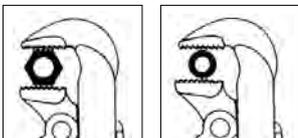

RENNSTEIG Pipe Wrenches

- All pliers are made of chrome vanadium steel, drop forged and hardened
- Teeth inductively hardened
- Jaws with double offset teeth
- Lean jaw design for better accessibility
- Double T-profile handles, reinforced guide sleeve
- Captive adjusting nut, pinch guard
- Powder coated in two colors
- Teeth bright ground

RENNSTEIG Offset Pipe Wrench, S-jaws

- 45° offset S-jaws, style C

Art. No.	Zoll Inch	mm	Länge Length mm	Gewicht Weight g	VPE PU	 DIN 5234
131 005 2	1/2	0-35	265	480	1	•
131 010 2	1	0-42	315	815	1	•
131 015 2	1 1/2	0-60	420	1510	1	•
131 020 2	2	0-70	530	2570	1	•
131 030 2	3	10-110	680	4295	1	•

RENNSTEIG Offset Pipe Wrench, 45° jaws

- 45° angled jaws, style B

Art. No.	Zoll Inch	mm	Länge Length mm	Gewicht Weight g	VPE PU	 DIN 5234
121 005 2	1/2	0-35	265	465	1	•
121 010 2	1	0-42	310	745	1	•
121 015 2	1 1/2	0-60	410	1380	1	•
121 020 2	2	0-70	570	2750	1	•
121 030 2	3	25-110	695	4380	1	•

RENNSTEIG Pipe Wrench, 90° jaws

- 90° angled jaws, style A

Art. No.	Zoll Inch	mm	Länge Length mm	Gewicht Weight g	VPE PU	 DIN 5234
111 010 2	1	0-42	305	785	1	•
111 015 2	1 1/2	0-60	405	1400	1	•
111 020 2	2	0-70	560	2690	1	•
111 030 2	3	10-105	650	3450	1	•
111 040 2	4	10-130	750	4940	1	•

RENNSTEIG Rohrzensets in Rolltasche

- schwarze Rolltasche aus strapazierfähigem Polyester-Gewebe mit zwei praktischen, verstellbaren Schnellverschlüssen
- bestückt mit vier verschiedenen Sortimenten an RENNSTEIG Rohrzensen
- Abmessungen geschlossen: ca. 600 x 140 x 80 mm



RENNSTEIG Pipe Wrench Sets in Roll-up Tool Pouch

- Black roll-up pouch made of durable polyester fabric with two practical, adjustable quick release fastener
- Equipped with four different assortments of RENNSTEIG pipe wrenches
- Dimensions closed: about 600 x 140 x 80 mm

RENNSTEIG SRS/Wapu Rohrzenset

Inhalt:

- Rohrzanze mit Schnellverstellung, 1 und 1 1/2 Zoll
- Wasserpumpenzange 10 Zoll

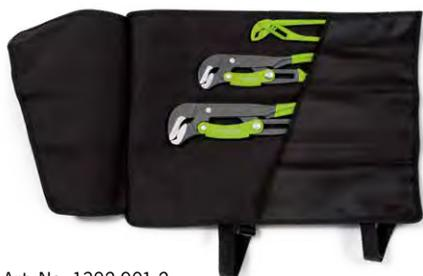

Art. No. 1302 901 2

RENNSTEIG SRS/Wapu Pipe Wrench Set

Content:

- Pipe Wrenches with quick adjustment, 1 and 1 1/2 inches
- Water pump pliers 10 inch

Art.No Set Set	Art. No. Rohrzensen Pipe Wrenches	Zoll Inch	Griffe Handles	 mm	 DIN 5234	Gewicht Weight g	VPE PU
1302 901 2	125 240 2	10		0-36		3360	1
	1302 010 2	1	•	0-42	•		
	1302 015 2	1 1/2	•	0-60	•		

RENNSTEIG S-Maul/Wapu Rohrzenset 1

Inhalt:

- RENNSTEIG Eckrohrzensen S-Maul, 1 und 1 1/2 Zoll
- Wasserpumpenzange 10 Zoll



Art. No. 131 911 2

RENNSTEIG S-jaws/Wapu Pipe Wrench Set 1

Content:

- RENNSTEIG Offset Pipe Wrenches, S-jaws, 1 and 1 1/2 inches
- Water pump pliers 10 inch

Art.No Set Set	Art. No. Rohrzensen Pipe Wrenches	Zoll Inch	Griffe Handles	 mm	 DIN 5234	Gewicht Weight g	VPE PU
131 911 2	125 240 2	10		0-36		3160	1
	131 010 2	1		0-42	•		
	131 015 2	1 1/2		0-60	•		

**Verformungsarm
und gratfrei schneiden**

*Cut without
deformation or burrs*

patentiert
patented



Art. No. 502 026 6



Schneiden des Schutzrohres

Cutting protective outer pipe



Schneiden von Aluminium-Verbundrohr

Cutting aluminum compound pipe



Kalibrieren und Anphasen der Verbundrohrenden

Calibration and chamfering composite pipe ends

Kombischere

- zum exakten, rechtwinkligen Schneiden von Aluminium-Verbund- und Kunststoffrohren in einem Durchmesserbereich von 12 bis 25 mm
- saubere, glatte und gratfreie Schnittflächen
- jetzt auch mit Dreiecksmesser für kraftoptimiertes Schneiden
- sicheres Schneiden von Riffelschutzrohr auf dem Außendurchmesser, ohne Beschädigung des innenliegenden Leitungsrohres
- problemloses Schneiden des Schutzrohres auch im Montagezustand durch kurze Schneidwege (90°)
- Möglichkeit zum Anbringen eines Kalibrierdorns z.B. für Geberitrohre Ø 11,5 und 15 mm
- austauschbare Messer
- auch ohne Schutzrohrschneider erhältlich
- ergonomisch geformte Zwei-Komponenten-Griffe



Art. No. 502 026 6

mit Kalibrierdorn
with calibration arbour



Art. No. 502 011 6

mit Dreiecksmesser, ohne Kalibrierdorn
with triangular blade, without calibration arbour



Art. No. 502 031 6

ohne Kalibrierdorn, ohne Schutzrohrschneider
without calibration arbour,
without protective pipe cutter

Pipe Cutter for composite and protective pipes



- Precise right-angle cutting of aluminum composite and plastic pipes from 12 to 25 mm diameter
- Clean, smooth, burr-free cuts
- Now available with triangular blade for better cutting performance
- Safe cutting of corrugated outer protective pipe without damaging the inner pipe
- Short cutting distances (90°) allow cutting of protective outer pipe when installed
- Option to install calibration arbour, e.g. for Geberit pipes of 11.5 and 15 mm diameter
- Replaceable blades
- Also available without outer pipe cutting attachment
- Ergonomically designed two-component handles

Art. No.	Bezeichnung Designation	Kapazität Capacity		Länge Length mm	Gewicht Weight g	VPE PU
		Verbundrohr Composite pipe Ø mm	Schutzrohr Protective pipe Ø mm			
502 026 6	mit Kalibrierdorn with calibration arbour	12–25	18–35	210	340	1
502 030 6	ohne Kalibrierdorn without calibration arbour	12–25	18–35	210	320	1
502 031 6	ohne Kalibrierdorn ohne Schutzrohrschneider without calibration arbour without protection pipe cutter	12–25	–	195	295	1
502 011 6	mit Dreiecksmesser ohne Kalibrierdorn with triangular blade without calibration arbour	12–25	18–35	210	330	1
502 021 0 0	Ersatzmesser (Rechteckform) für Aluminium-Verbundrohr Replacement rectangular blade for aluminum composite pipe					1
502 011 0 0	Ersatzmesser (Dreieckform) für Aluminium-Verbundrohr Replacement triangular blade for aluminum composite pipe					1
502 022 0 0	Ersatzmesser für Schutzrohr Replacement blade for protective pipe					1
502 023 3 0	Kalibrierdorn für Rohre Ø 11,5 und 15 mm Calibration arbour for 11.5 and 15 mm dia. pipe					1



Schneiden mit der Kombischere – exakter Schnitt ohne Deformierung des Rohres

Cutting with the Rennsteig pipe cutter – a smooth precision cut that does not deform the pipe.



Schneiden mit herkömmlichen Scheren – hoher Kraftaufwand, hohe Verformung des Rohres

Cutting with conventional cutters – high effort, high deformation of the pipe.

Rohrschere ECO für Kunststoff-Verbundrohre

- zum exakten rechtwinkligen Schneiden von Aluminium-Verbund- und Kunststoffrohren in einem Durchmesserbereich von 12 bis 25 mm (nicht zum Schneiden von Kabel geeignet)
- saubere, glatte und gratfreie Schnittflächen
- wechselbare Messer aus hochfestem Spezialstahl, in Öl gehärtet und angelassen
- ergonomisch geformte Griffe aus glasfaserverstärktem Kunststoff



Art. No. 502 037 6



Art. No. 502 033 6

ECO Pipe Cutter for composite plastic pipe

- For precise right-angle cutting of aluminum composite and plastic pipes from 12 to 25 mm dia. (not suitable for cutting cable)
- Clean, smooth, burr-free cuts
- replaceable blades of special high-strength steel, oil-hardened and tempered
- Ergonomically designed glass-fibre reinforced plastic handles



Art. No.	Bezeichnung Designation	Kapazität Pipe dia. Ø mm	Länge Length mm	Gewicht Weight g	VPE PU
502 037 6	Rohrschere mit geradem Messer Pipe Cutter with straight blade	12–25	185	180	1
502 033 6	Rohrschere mit Dreieckmesser Pipe Cutter with triangular blade	12–25	185	180	1
502 021 0 0	Ersatzmesser (Rechteckform) Replacement blade (square)				1
502 011 0 0	Ersatzmesser (Dreieckform) Replacement blade (triangular)				1

Ratschenschere 40

- für Aluminium-Verbund- und Kunststoffrohr ø 26–40 mm
- exakter, gratfreier Schnitt durch automatische Anpassung der Rohrabstützung
- Arbeiten nach dem Ratschenprinzip
- hoher Sicherheitsstandard
- ergonomisch geformte Zwei-Komponenten-Griffe
- Burr-free cutting of aluminum composite and plastic pipes ranging from 26 to 40 mm diameter
- Precise vertical cut by automatic adaptation to pipe support
- One-hand operation using ratchet mechanism
- High safety standard
- Ergonomically designed two-component handles



patentiert
patented

Ratchet Pipe Cutter 40



Art. No.	Kapazität Pipe dia. Ø mm	Länge Length mm	Gewicht Weight g	VPE PU
502 040 6	26–40	210	465	1
502 040 0 0	Ersatzmesser Spare blade			1



Vermeidung von Leerhüben durch automatische Messerzustellung auf den jeweiligen Rohrdurchmesser

Automatic adjustment for the pipe diameter prevents idle strokes

Sanitärkreuzschlüssel

- gefertigt aus Werkzeugstahl, pulverlackiert
- zum Ein- und Ausdrehen von Stopfen, Hahnverlängerungen, Heizkörperventilen und Rücklaufverschraubungen



Art. No. 181 200 2



Art. No. 181 201 2

Rohrschneider für Schutzrohre und Schläuche

- zum Schneiden von dünnwandigen Kunststoffrohren (z. B. Kunststoff-Panzerrohre) und Schläuchen, auch gewebeverstärkt, aus Kunststoff und Gummi bis Ø 25 mm Außendurchmesser
- nicht zum Kabelschneiden geeignet
- mit Öffnungsfeder und Sperrklinke
- Werkzeugkörper: Kunststoff, glasfaserverstärkt
- Messer: Spezial-Werkzeugstahl, ölgehärtet, auswechselbar



Plumbing Wrench

- Powder-coated tool steel
- For screwing in and out stop cocks, extensions, radiator valves and lockshields



Art. No.	Anwendungsbereich <i>Application</i>	Länge <i>Length</i> mm	Gewicht <i>Weight</i> g	VPE <i>PU</i>
181 200 2	7-fach Funktion: 4 Außen-Sechskante: 3/8", 1/2", 3/4", 1" 3 Innengewinde M8, M10 und M12 für Stockschrauben Einstecklänge 90 mm 7 functions: 4 outside hexagonal profiles, 3/8", 1/2", 3/4", 1" 3 M8, M10 and M12 threaded sockets for hanger bolts Maximum insertion 90 mm	200	520	1
181 201 2	10-fach Funktion: 4 Außen-Sechskante mit Doppelnutmitnahmen für Hahnverlängerungen 9,5mm (3/8") - 12,7mm (1/2") - 19,0mm (3/4") - 25,4mm (1") 2 Innengewinde M 10 und M 12 für Stockschrauben 2 Innenvierkante für Rohrstopfen: 9,5mm (3/8) und 12,7mm (1/2") Einstecklänge 100 mm 10 functions: 4 outside hexagonal profiles with double grooves for extensions, 9.5mm (3/8") - 12.7mm (1/2") - 19.0mm (3/4") - 25.4mm (1") 2 M10 and M12 threaded sockets for hanger bolts 2 square sockets for stop cocks, 9.5mm (3/8") and 12.7mm (1/2") Maximum insertion 100 mm	220	570	1

Cutter for protective pipe and hose

- For cutting thin-walled plastic (such as plastic protective outer pipe) and plastic and rubber hose, including fabric-reinforced, up to 25 mm outer diameter
- Not for cable cutting
- With opening spring and lock
- Tool body glass-fibre reinforced
- Blade of special tool steel, oil-hardened, replaceable



Art. No.	Kapazität <i>Pipe dia.</i> Ø mm	Länge <i>Length</i> mm	Gewicht <i>Weight</i> g	VPE <i>PU</i>
502 038 6	25	185	172	1
502 038 0 0	Ersatzmesser <i>Spare blade</i>			1

**Rohre und Schläuche
rechtwinklig schneiden**
*Right-angle cutting
of hoses and pipes*



Art. No. 502 1001 6



Universalaufgabe zum rechtwinkligen Positionieren
Universal support for perpendicular positioning



Schneiden von Flüssigkeits-, Mehrschicht-, und
Pneumatikschläuchen/-rohren
*Cutting of industry-standard liquid, multi-layer and
pneumatic hoses and tubing*



Klinge austauschbar
Replaceable blade

Rohr- und Schlauchschere Perfect Cut

- geeignet für alle marktüblichen Flüssigkeits-, Mehrschicht-, und Pneumatikschläuche/-rohre
- großer Anwendungsbereich von Ø 4 mm – 20 mm
- automatische Öffnung durch Federmechanismus
- geringe Handkraft (< 100 N)
- dauerhaft scharfe, hochwertige Klinge mit hoher Standzeit, austauschbar
- ergonomisches Griffdesign



Tube and hose shears Perfect Cut

- Compatible with all industry-standard liquid, multi-layer and pneumatic hoses and tubing
- Handles wide range of diameters from Ø 4 mm to 20 mm
- Opens automatically with spring mechanism
- Low manual force needed (<100 N)
- Permanently sharp, pro-quality blade with a long service life, replaceable
- ergonomic handle design



Art. No.	Bezeichnung Designation	Kapazität Pipe dia. Ø mm	Länge Length mm	Gewicht Weight g	VPE PU
502 1001 6	Rohr- und Schlauchschere Perfect Cut Tube and hose shears Perfect Cut	4-20	185	190	1
502 021 0 0	Ersatzmesser (Rechteckform) Replacement blade (square)				1
502 011 0 0	Ersatzmesser (Dreieckform) Replacement blade (triangular)				1

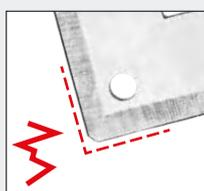

Vergleichsprodukt
Comparable product



Perfect Cut

> 20.000 Schnitte
durch Verbundrohr
> 20,000 cuts through
composite tube

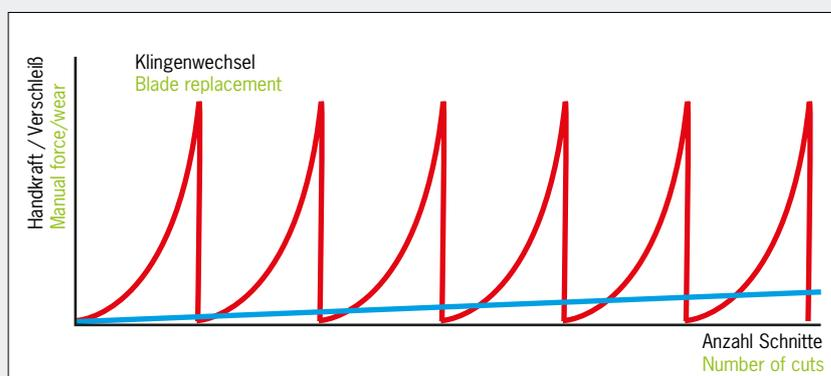

Entwicklung der Handkraft durch Verschleiß
Effect of wear on manual force required

Effiziente Problemlöser: Spezialwerkzeuge von RENNSTEIG.

In der Industrie und im Handwerk werden heute verschiedenste Verfahren in immer kürzeren Zeitabständen weiter entwickelt. So entstehen neue Techniken und veränderte Einsatzaufgaben, für die spezielle Handwerkzeuge entwickelt und produziert werden müssen. Effiziente Problemlösungen stehen hierbei im Vordergrund.

Spezialwerkzeuge kommen unter anderem im Automobil- und Windkraftanlagenbau zum Einsatz, ebenso im Maschinen- und Werkzeugbau. Gebraucht werden sie bei der Fertigung, Montage und Reparatur von Teilen oder Baugruppen. Dabei muss jedes Werkzeug so beschaffen sein, dass es präzises und einfaches Montieren sowie beschädigungsfreies, ergonomisches und sicheres Arbeiten ermöglicht.

Wo zur Bearbeitung verschiedenster Materialien, Formen und Größen spezielle Hilfsmittel notwendig sind, bringt jeder durch Spezialwerkzeuge vereinfachte Arbeitsgang dem Unternehmen einen direkten Nutzen. Zeit und Kosten werden eingespart und gleichzeitig ist höchste Arbeitssicherheit gewährleistet. Das ist Grundlage einer störungsfreien Produktion.

RENNSTEIG entwickelt in Zusammenarbeit mit den Anwendern maßgeschneiderte Werkzeuge für Arbeitsaufgaben in unterschiedlichsten Einsatzbereichen. Dabei arbeiten unsere Ingenieure in enger Kooperation mit den zukünftigen Benutzern, um Spezialwerkzeuge zu schaffen, die alle vorgegebenen Qualitätsparameter erfüllen und zum Teil übertreffen.

Efficient problem-solvers: Special Tools from RENNSTEIG.

Today, new processes and work methods are being developed and improved at an accelerating rate. Tradespeople and technicians use an expanding range of techniques, and need the special tools to use them efficiently. The priority is on effective problem-solving.

Special tools are used in the automotive industry, wind power, mechanical engineering, toolmaking, and many other industries, in production, assembly, and repair. To be useful, a tool needs to enable precise, ergonomic, safe, and damage-free work.

Special tools simplify work with new materials, shapes and sizes, bringing users and companies tangible benefits. They save time and costs, while at the same time helping maximize work safety - an important part of trouble-free production and maintenance work.

In close cooperation with users, RENNSTEIG engineers develop tailor-made tools for a wide variety of applications and industries, that meet and often exceed all quality parameters.

Spezialwerkzeuge *Special Tools*



Dichtungen flexibel herstellen
Manufacture various seal sizes



Art. No. 140 026 0



konischer Schneidkopf, geschliffen und blank,
innen leicht konisch zum Entfernen der Ausschnitte

*Conical cutting head, polished and blank, slightly
conical on the inside to remove stamped out material*



Schneide geschärft, gehärtet und angelassen

Cutting edge sharpened, hardened and tempered



Laserkennzeichnung

Laser engraved

Henkellocheisen

- zum Lochen oder Herstellen von Dichtungen und Dichtungsringen aus Gummi, Leder, Filz, Kunststoff, Kork, Stoff oder ähnlichen Materialien
- als Schlagunterlage beim Stanzen sind Mehrschicht-holzplatten oder Polyamidplatten zu verwenden
- gefertigt aus Werkzeugstahl nach DIN 7200 A
- schwarz tauchlackiert



Art. No. 140 002



Art. No. 140 012



Art. No. 140 026

Wad Punches

- For stamping out or producing gaskets and seal rings from materials such as rubber, leather, felt, plastic, cork, fabric or similar components
- Multi-layered wooden boards or polyamide boards should be used as a base impact support for stamping
- Made of tool steel according to DIN 7200 A
- Black dip-coating



Art. No.	Länge Length mm	Loch-Ø Hole dia. mm	Loch-Ø Hole dia. Zoll Inch	Gewicht Weight g	VPE PU
140 002 0	100	2	1/16	40	10
140 003 0	100	3	1/8	45	10
140 004 0	100	4	5/32	45	10
140 005 0	105	5	3/16	55	10
140 006 0	105	6	1/4	55	10
140 007 0	105	7	9/32	55	10
140 008 0	115	8	5/16	80	10
140 009 0	115	9	11/32	80	10
140 010 0	115	10	3/8	80	10
140 011 0	125	11	7/16	115	10
140 012 0	125	12	15/32	115	10
140 013 0	125	13	1/2	115	10
140 014 0	135	14	9/16	160	10
140 015 0	135	15		165	10
140 016 0	135	16	5/8	160	10
140 017 0	135	17		160	6
140 018 0	140	18	11/16	195	6
140 019 0	140	19	3/4	195	6
140 020 0	140	20	25/32	190	6
140 021 0	160	21		270	6
140 022 0	160	22	7/8	285	6
140 023 0	160	23		275	6
140 024 0	160	24	15/16	270	6
140 025 0	165	25	1	380	6
140 026 0	165	26		375	6
140 027 0	165	27	1 1/16	375	3
140 028 0	175	28	1 1/8	455	3
140 029 0	175	29		435	3
140 030 0	175	30		435	3
140 031 0	175	31	1 3/16	500	3
140 032 0	175	32	1 1/4	490	3
140 033 0	175	33		490	3
140 034 0	180	34		595	3
140 035 0	180	35		590	3

Spezialwerkzeuge *Special Tools*

Art. No.	Länge <i>Length</i> mm	Loch-Ø <i>Hole dia.</i> mm	Loch-Ø <i>Hole dia.</i> Zoll <i>Inch</i>	Gewicht <i>Weight</i> g	VPE <i>PU</i>
140 036 0	180	36	1 3/8	585	3
140 037 0	180	37		575	3
140 038 0	190	38	1 1/2	710	3
140 039 0	190	39		705	3
140 040 0	190	40		700	2
140 041 0	205	41		1090	2
140 042 0	205	42	1 5/8	1080	2
140 043 0	205	43		1000	2
140 044 0	205	44		1000	2
140 045 0	205	45	1 3/4	1035	2
140 046 0	205	46		1035	2
140 047 0	215	47		1035	2
140 048 0	215	48	1 7/8	1035	2
140 049 0	215	49		1030	2
140 050 0	215	50	2	1015	2
140 055 0	220	55		1540	1
140 060 0	240	60		1745	1
140 065 0	240	65		1675	1
140 070 0	250	70	2 3/4	2210	1
140 075 0	255	75		2320	1

größere Lochdurchmesser auf Anfrage
Larger hole diameters available on request

Art. No.	Ausführung <i>Version</i>	Bestückung <i>Contents</i>	Gewicht <i>Weight</i> g	VPE <i>PU</i>
140 900 0	9 Stück in Rolltasche 9-piece set in roll-up pouch	Lochdurchmesser 3–19 mm (in Stufen von 2 mm steigend) Hole diameter 3–19 mm (in increments of 2 mm)	1030	1
140 901 0	19 Stück in Rolltasche 19-piece set in roll-up pouch	Lochdurchmesser 2–20 mm (in Stufen von 1 mm steigend) Hole diameter 2–20 mm (in increments of 1 mm)	2200	1
140 902 0	15 Stück in Rolltasche 15-piece set in roll-up pouch	Lochdurchmesser 2–30 mm (in Stufen von 2 mm steigend) Hole diameter 2–30 mm (in increments of 2 mm)	3060	1



Art. No. 140 900



Art. No. 140 901



Revolverlochzange

- mit 6 auswechselbaren Lochpfeifen
Ø 2,0/2,5/3,0/3,5/4,0/5,0 mm
- zum Ausstanzen von Löchern
in Papier, Leder, Textilien, Kunststoffmaterial
- Zangenkörper aus Stahlblech



Art. No. 103 220 2 Revolverzange pulverlackiert
Punch pliers, powder coated



Art. No. 104 220 4 Revolverzange mit Griffhülle
Punch pliers with plastic grips

Revolving Punch Pliers

- With six replaceable punches
dia. 2,0/2,5/3,0/3,5/4,0/5,0 mm
- For punching holes in paper, leather,
textiles or plastic material
- Pliers body of steel



Art. No.	Ausführung Design	Länge Length mm	Arbeitsbereich Application	Gewicht Weight g	VPE PU
103 220 2	pulverlackiert powder coated	240	2-5 mm	260	1
104 220 4	mit Griffhülle with plastic grips	240	2-5 mm	260	1
105 220 4	Art. No. 104 220 4 auf Karte Art. No. 104 220 4 on card	240	2-5 mm	280	1



Sicherungsringzange für Innenringe

- abrutschhemmende, stabile Präzisionsspitzen für Innenringe (Bohrungen), auswechselbar
- für Ringe Ø 122–400 mm
- Spitzen vergütet, verzinkt
- Griffe: Stahlblech, schwarz pulverlackiert



Sicherungsringzange für Außenringe

- mit auswechselbaren Präzisionsspitzen für Außenringe (Wellen)
- für Ringe Ø 122–400 mm
- Spitzen vergütet, verzinkt
- Griffe: Stahlblech, schwarz pulverlackiert



Internal Circlip Pliers



- Precision tips for circlips in bore hole: solid design, no slipping, replaceable
- For circlips of 122–400 mm diameter
- Tips are made of tempered steel, zinc plated
- Handles of steel, black powder coated

Art. No.	Größe Size	Spitze Tips Ø mm	Form Form	für Bohrung Bore Ø mm	Länge Length mm	Gewicht Weight g	VPE PU
780 035 2	I5	3,5		122–300	570	1720	1
780 045 2	I6	4,5		252–400	580	1740	1
780 035 5 0	I5	3,5		Ersatzspitzenpaar <i>spare tips</i>			1
780 045 5 0	I6	4,5		Ersatzspitzenpaar <i>spare tips</i>			1
780 135 2	I51	3,5		122–300	590	1800	1
780 145 2	I61	4,5		252–400	595	1800	1
780 135 5 0	I51	3,5		Ersatzspitzenpaar <i>spare tips</i>			1
780 145 5 0	I61	4,5		Ersatzspitzenpaar <i>spare tips</i>			1
780 000	Zange ohne Spitzen <i>pliers without tips</i>				548	1620	1

External Circlip Pliers

- Precision tips for circlips on shafts: solid design, no slipping, replaceable
- For circlips of 122–400 mm diameter
- Tips are made of tempered steel, zinc plated
- Handles of steel, black powder coated

Art. No.	Größe Size	Spitze Tips Ø mm	Form Form	für Wellen Shaft Ø mm	Länge Length mm	Gewicht Weight g	VPE PU
782 035 2	A5	3,5		122–300	560	1760	1
782 045 2	A6	4,5		252–400	570	1780	1
782 035 5 0	A5	3,5		Ersatzspitzenpaar <i>spare tips</i>			1
782 045 5 0	A6	4,5		Ersatzspitzenpaar <i>spare tips</i>			1
782 135 2	A51	3,5		122–300	580	1820	1
782 145 2	A61	4,5		252–400	585	1820	1
782 135 5 0	A51	3,5		Ersatzspitzenpaar <i>spare tips</i>			1
782 145 5 0	A61	4,5		Ersatzspitzenpaar <i>spare tips</i>			1
782 000	Zange ohne Spitzen <i>pliers without tips</i>				540	1640	1

Sicherungsringwerkzeug SRW 1000

- universell einsetzbar für Sicherungsringe von \varnothing 400–1000 mm
- sicheres Öffnen / Schließen der Ringe und Halten durch selbsthemmenden Präzisions-Spindeltrieb
- sicherer Halt des Ringes durch kurze, direkte Aufnahmen
- hochfeste, vergütete Spitzen
- maximale Öffnungsweite 260 mm
- Bedienung wahlweise mit Innensechskantschlüssel, Ratschenschlüssel oder Akku-Schrauber
- wechselbare Spitzenpaare für unterschiedliche Durchmesserbereiche



Retaining Ring Tool SRW 1000

- Usable with any retaining rings from 400–1000 dia.
- Securely opens, closes and holds rings thanks to a self-locking precision spindle action
- Holds rings securely due to short, direct-contact sockets
- High-strength, hardened and tempered tips
- Opening width up to 260 mm
- Can be operated with Allen key, ratchet wrench or cordless screwdriver
- Interchangeable paired tips to cover different diameter ranges



Art. No.	Artikel Article	Länge Length mm	Gewicht Weight g	VPE PU
783 000 61	Set im Kunststoffkoffer: Sicherungsringwerkzeug, Spitzenpaar \varnothing 6 und 9 mm, Innensechskantschlüssel 6 mm, Bit 6 / 1/4" Set in plastic case includes: retaining ring tool, paired tips dia. 6 and 9 mm, Allen key 6 mm, bit 6 1/4"	300	2150	1
783 006 30	Ersatzspitzenpaar Durchmesser 6 mm für Ringe bis 690 mm Set of replacement tips, diameter 6 mm for rings up to 690 mm	60	90	1
783 009 30	Ersatzspitzenpaar Durchmesser 9 mm für Ringe ab 700 mm (DIN) Set of replacement tips, diameter 9 mm for rings from 700 mm (DIN)	60	100	1

Abweichende Spitzendurchmesser auf Anfrage
Different tip diameters on request

patentiert
patented



Auslieferung im Kunststoffkoffer
Supplied in plastic case



Wechselbare Einsätze für Innen- und Außenringe
Interchangeable inserts for inner and outer rings



Maschinell oder von Hand zu betätigen
Power tool or manual operation

Spezialwerkzeuge *Special Tools*

Einfach und exakt ausklinken
mit System
Simple and precise notching

patentiert
patented



Art. No. 503 002 3

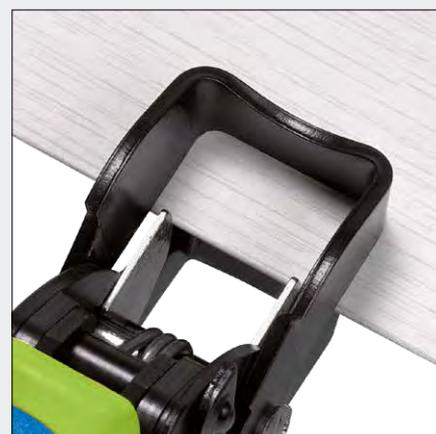
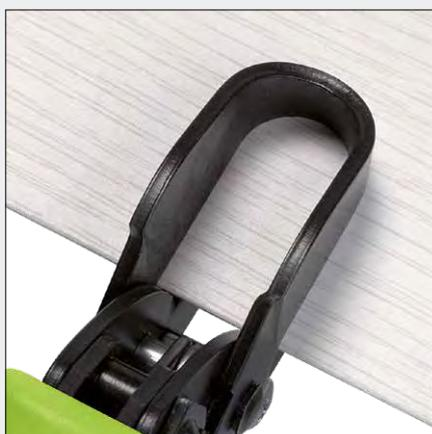

Mögliche Ausklinkprofile

Notch profiles



Werkzeuglösungen *Tool solutions*

Ausklinkzangen

- zum Ausklinken von Aussparungen aus Kunststoffgehäusen für die Elektro- und Sanitärinstallation
- leichter ziehender Schnitt (Scherenprinzip)
- saubere Schnittkanten, exaktes Schneiden der Gummilippe an der Sockelleiste
- unterschiedliche Schnittformen und Griff­längen
- Zange öffnet selbsttätig
- Schneidkopf aus Spezialwerkzeugstahl
- Oberfläche brüniert
- Griffe mit Kunststoffüberzug oder Zwei-Komponenten-Griffe



Art. No. 503 002 3



Art. No. 503 001 39



Art. No. 503 102 3 / 503 103 3

mit spezieller Schneidengeometrie zum Ausklinken von Aussparungen aus Dehnungsfugenprofilen
Special blade geometry for recesses in section material of expansion gaps

Notching Pliers

- For notching plastic skirtings, cases and cable ducts for plumbing related and electric installation
- Easy shear-action draw cut
- Neat cut edges, precise cuts in rubber lips on skirtings
- Available with different cutting profiles and grip lengths
- Easy handling with automatic spring opening after notching
- Cutting head of special tool steel
- Black-oxide finish
- Plastic coated grips or two-component handles



Art. No.	Bezeichnung Designation	Schnittform Notch profile	Schnittbreite Cutting width a in mm	Schnittiefe Cutting depth b in mm	Länge Length mm	Gewicht Weight g	VPE PU
503 002 3	Ausklinkzange 16 Notching pliers 16		16	32	190	345	1
503 002 39	Ausklinkzange 16L Notching pliers 16L		16	32	250	410	1
503 001 3	Ausklinkzange 20 Notching pliers 20		20	29	185	345	1
503 001 39	Ausklinkzange 20L Notching pliers 20L		20	29	245	425	1
503 003 3	Ausklinkzange 26 mit Tiefenanschlag Notching pliers 26 with depth stop		26	15 b'26	180	365	1
503 003 39	Ausklinkzange 26L mit Tiefenanschlag Notching pliers 26L with depth stop		26	15 b'26	240	450	1
503 102 3	mit spezieller Schneidengeometrie zum Ausklinken von Aussparungen aus Dehnungsfugen- profilen		16	32	190	345	1
503 103 3	Special blade geometry for recesses in section material of expansion gaps		26	26	180	365	1



Ausklinken von Aussparungen
aus Dehnungsfugenprofilen
Recesses in section material
of expansion gaps

Auslinkzange für Gummidichtungen

- Auslinkzange zum Auslinken von Gummidichtungen für Glasfassadenbauelemente



Art. No. 503 022 3

Notching Pliers for rubber gaskets

- For notching the rubber gaskets of glass facade panels

Art. No.	Schnittform <i>Notching profile</i>	Schnittbreite <i>Cutting width</i> a in mm	Schnitttiefe <i>Cutting depth</i> b in mm	Länge <i>Length</i> mm	Gewicht <i>Weight</i> g	VPE <i>PU</i>
503 021 3		51	15	200	550	1
503 022 3		61	15	200	585	1



Auslinkzange für Verdrahtungskanäle

- Spezialzange zum Auslinken von Stegen aus Verdrahtungskanälen
- Schnittlänge mit einem Schnitt bis 80 mm
- Schnittbreite 24 mm
- sauberer, gratfreier Schnitt bis zum Kanalboden
- Matrize mit integriertem Auswerfer der Abschnittslängen

patentiert
patented



Art. No. 503 618 3

Notching Pliers for wiring ducts

- Special tool for notching tabs in wiring ducts
- Up to 80 mm cut length with a single cut
- Cut width 24 mm
- Clean, burr-free cut to the bottom of the duct
- Matrices with integrated cut section ejector

Art. No.	Schnittform <i>Notching profile</i>	Schnittbreite <i>Cutting width</i> a in mm	Schnitttiefe <i>Cutting depth</i> b in mm	Länge <i>Length</i> mm	Gewicht <i>Weight</i> g	VPE <i>PU</i>
503 618 3		24	variabel max. 80 variable max. 80	260	660	1



Pelikanschere

- zum gratfreien Schneiden von Kunststoffplatten, Sockelleisten und Kabelkanälen
- sehr gute Schneidwirkung auch an der Scherenspitze
- gleichbleibende Handkraft über die gesamte Schneidlänge durch optimale Hebelübersetzung
- in zwei Ausführungen mit Schnittlängen von 60 mm und 110 mm erhältlich
- Schere mit Schnittlänge 110 mm mit Auflage für Gehrungsschnitte erhältlich

patentiert
patented



Art. No. 502 060 3



Art. No. 502 111 3

Pelican Cutter

- For burr-free cuts of plastic panels, baseboards and cable ducts
- Great cutting performance even at the tip of the blade
- Force is evenly distributed over the entire blade length because of the optimal leverage transfer
- Two versions, with 60 mm or 110 mm cut lengths
- 110 mm cutter version available with positioner for bevel cuts



Art. No.	Ausführung Finish	Schnittlänge Cutting length mm	Länge Length mm	Gewicht Weight g	VPE PU
502 060 3	brüniert black-oxide finish	bis 60 up to 60	220	450	1
502 110 3	brüniert black-oxide finish	bis 110 up to 110	280	520	1
502 111 3	Modell 502 110 3 mit Auflage für Platten und Kanäle Model 502 110 3 with positioner for plates / trunks			630	1
502 060 0 0	Ersatzmesser 60 mm spare blades 60 mm			30	1
502 110 0 0	Ersatzmesser 110 mm spare blades 110 mm			60	1
502 111 0 0	Ersatz-Auflage spare positioner for plates / trunks			110	1



**Werkstücke variabel spannen
und fixieren**

Get a lockdown on workpieces



Alle Zangenkörper aus Stahlblech, Oberfläche galvanisiert, verstellbarer Spannungsbereich, Spannen über Kniehebel und Lösen mittels Schnell-Lösehebel

All pliers of steel, galvanized surface, adjustable clamping range, toggle lever clamping and quick action lever release

Art. No. 162 250 5



Klemmbacken für runde, flache und eckige Werkstücke

Jaws for round, flat and cornered workpieces



Lösehebel

Release lever



Stellschraube für Öffnungsweite

Opening width adjusting screw

Gripzange mit Drahtschneider

- Zum Spannen und Halten von Werkstücken
- Zangenbacken aus Chrom-Vanadium-Stahl, geschmiedet



Locking Pliers with wire cutter

- For clamping and holding work pieces
- Jaws made of drop-forged chrome vanadium steel



Art. No.	Länge Length mm	Länge Length Zoll Inch	 	 	Gewicht Weight g	VPE PU
160 180 5	185	7	8–30 mm	0–20 mm	320	1
160 250 5	250	10	8–40 mm	0–20 mm	510	1
160 300 5	300	12	10–65 mm	0–30 mm	1010	1

Ideal-Gripzange

- Zum Spannen und Halten von Profilen und Rohren durch Dreipunktauflage
- ein doppeltes Prisma im Zangenmaul ermöglicht auch den Einsatz kleinster Querschnitte.
- Zangenbacken aus Chrom-Vanadium-Stahl, geschmiedet



Perfect Locking Pliers

- For clamping and holding work pieces and pipes securely with three point grip
- Jaws with double prism for a good grip even on small cross-sections
- Jaws made of drop-forged chrome vanadium steel

Art. No.	Länge Length mm	Länge Length Zoll Inch		Gewicht Weight g	VPE PU
162 250 5	250	10	0–36 mm	540	1

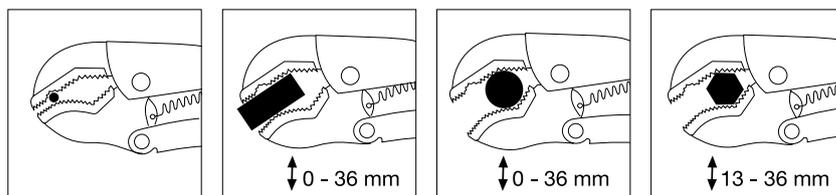

Gripzange mit geraden Backen

- Zum Spannen und Halten von Werkstücken
- Spezialverzahnung und Zangenmaulform ermöglichen das Spannen an der Maulspitze
- Zangenbacken aus Chrom-Vanadium-Stahl, geschmiedet



Locking Pliers with straight jaws

- For clamping and holding work pieces
- Specially designed teeth and straight jaws allow clamping at the jaw tip
- Jaws made of drop-forged chrome vanadium steel

Art. No.	Länge Length mm	Länge Length Zoll Inch			Gewicht Weight g	VPE PU
163 250 5	250	10	0-42 mm	0-16 mm	520	1

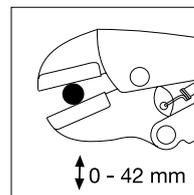
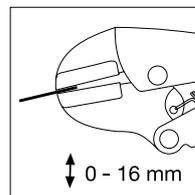

Rohr-Gripzange

- Zum Vorspannen und Zurückholen des Schutzrohres bei der Montage von Fittings mit Kunststoffrohren in der Heizungs- und Sanitärtechnik



Pipe Locking Pliers

- For gripping and pulling back outer protective pipe when working on plastic pipes in heating and plumbing installation

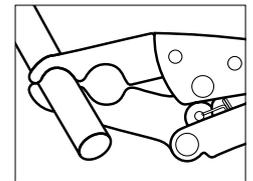

Art. No.	Länge Length mm	Länge Length Zoll Inch	Rohr Pipe Ø mm	Gewicht Weight g	VPE PU
166 250 4	250	10	16/17, 20	495	1

Schweißer-Gripzange

- Zum Halten und Anpassen von Blechen und Profilen
- Zangenbacken aus hochwertigem Temperguß



Welding Locking Pliers

- For gripping and fitting sheet metal and profiles
- Jaws of high-grade malleable cast iron

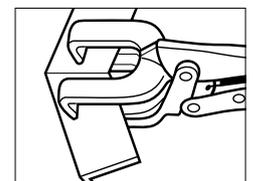

Art. No.	Länge Length mm	Länge Length Zoll Inch			Gewicht Weight g	VPE PU
171 280 5	280	11	30-65 mm	0-55 mm	920	1

Rohr-Schweißer-Gripzange

- Zum Halten und Anpassen von Rohren durch Dreipunktauflage
- Zangenbacken aus hochwertigem Temperguß



Pipe Locking Pliers

- For three-point gripping and fitting of pipes and round material
- Jaws of high-grade malleable cast iron

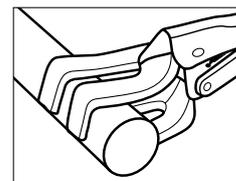

Art. No.	Länge Length mm	Länge Length Zoll Inch		Gewicht Weight g	VPE PU
172 280 5	280	11	12-90 mm	880	1

Klammer-Gripzange

- Zum Halten und Anpassen von Profilen und sperrigen Teilen
- Zangenbacken aus Chrom-Vanadium-Stahl, geschmiedet



Clamp Locking Pliers

- For gripping and fitting bulky work-pieces or pieces with deep recess
- Jaws of chrome vanadium steel, forged

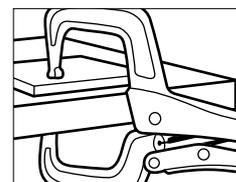

Art. No.	Länge Length mm	Länge Length Zoll Inch		Gewicht Weight g	VPE PU
173 280 5	280	11	0-80 mm	680	1

Sicherheit und Ergonomie: Werkzeuge zur Metallverarbeitung von RENNSTEIG.

Moderne Formen der Metallverarbeitung erfordern immer hochwertigere und speziellere Werkzeuge. Lange Standzeiten, gute Elastizität und Belastbarkeit sind die entscheidenden Anforderungen, die ein hochwertiges Werkzeug erfüllen muss.

Unsere Schlagwerkzeuge erreichen oder übertreffen die einschlägigen DIN-Normen. Die hohe Qualität erzielen wir durch den Einsatz ausgewählter Materialien und durch höchste Sorgfalt in der Verarbeitung. Meißel, Körner und Splintentreiber werden aus hochwertigem Chrom-Vanadium-Lufthärtestahl hergestellt. Alle Schlagwerkzeuge werden durchgängig vergütet, so dass die von der DIN 7255 geforderte Härte zwischen 54 und 58 HRC nicht nur am Arbeitsende erreicht wird, sondern das gesamte Werkzeug auszeichnet. Diese Verarbeitung lässt ein homogenes Gefüge des Werkzeugs entstehen, das außergewöhnlich lange Standzeiten garantiert. Es leitet die Schlagkraft optimal ans Arbeitsende weiter und erleichtert so dem Anwender seine tägliche Arbeit. Darüber hinaus lassen sich die Werkzeuge problemlos nachschleifen.

RENNSTEIG legt besonderen Wert auf die Sicherheit des Anwenders. Alle unsere Schlagwerkzeuge verfügen über einen Sicherheitsschlagkopf nach DIN 7255. Die durch eine zusätzliche Wärmebehandlung auf 38 bis 46 HRC reduzierte Härte am Schlagkopf unterbindet gefährliche Absplitterungen. Gleichzeitig reicht die Härte aus, um ungewünschte Wulstbildungen zu vermeiden. Dennoch ist die Einhaltung der gültigen Arbeitsschutzbestimmungen (z.B. das Tragen einer Schutzbrille) durch den Anwender unerlässlich.

Alle unsere Schlagwerkzeuge werden am Arbeitsende geschliffen. Bei allen Handmeißeln kann der Anwender außerdem zwischen einer am Arbeitsende polierten oder einer lackierten Variante auswählen.

Safety and ergonomics: Metalworking Tools from RENNSTEIG.

Modern metalworking techniques demand ever more specialized and higher quality tools that provide long service life, high elasticity and toughness.

Our striking tools meet or exceed all applicable DIN standards. We achieve our superb quality through the use of selected materials and diligent manufacturing processes. Our chisels, centre punches and parallel pin punches are forged from top quality hardened chrome vanadium steel. All of our striking tools are tempered to a hardness of 54 to 58 HRC - not just at the tip of the tool, but throughout the tool. This gives the tool an homogeneous structure that ensures an extended long service life, and also transfers the full striking force to the tip of the tool and makes the user's job easier. It also means these tools can be reground repeatedly and still retain their full effectiveness.

RENNSTEIG pays special attention to user safety. All of our striking tools have safety striking heads acc. to DIN 7255 standards. Supplementary heat treatment reduces the hardness at the head to 38 to 46 HRC in order to reduce the danger of splintering. At the same time, the hardness is sufficient to prevent undesirable spreading.

However, the user always needs to obey the relevant health and safety regulations, e.g. wearing of safety goggles.

All of our striking tools are ground at the tip, and on our hand chisels the user can also choose between polished or painted tips versions.

Werkzeuge für den Metallbereich

Metalworking Tools

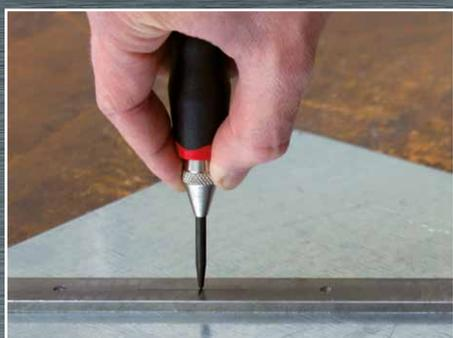

**Sicher demontieren
mit Werkzeugen
höchster Präzision**

**Safe disassembly
with top precision**



Art. No. 425 530 6 RC



Abgerundete Kanten

- alle Kanten des Splintentreibers sind abgerundet
- Absplitterung und Bartbildung an der Nadel werden nahezu vermieden
- Verringerung des Verletzungsrisikos des Anwenders
- keine Beschädigung des Werkstückes

Rounded edges

- All edges of the pin punch are rounded
- Splitting and burring at the tip are almost entirely eliminated
- Reduced risk of injury
- No damage to the workpiece



Verbesserte Oberfläche

Hochglänzende, glatte Oberfläche

Improved finish
High-polished finish



Know How unter dem Lack

Vergüteter Sicherheitsschlagkopf

Quality that goes deep
Tempered safety head

Splintentreiber

Splintentreiber „Exklusiv“

- hochlegierter Werkzeugstahl, durchgängig vergütet, Härte ≥ 58 HRC,
- Sicherheitsschlagkopf
- Hochglanz poliert
- pulverbeschichtet

Splintentreiber „Standard“

- neue verbesserte Qualität
- geschliffene und polierte Oberfläche
- abgerundete Kanten
- Chrom-Vanadium-Stahl
- tauchlackiert

Parallel Pin Punches

“Exclusive” Parallel Pin Punch

- High-alloy tool steel, tempered throughout, ≥ 58 HRC
- Safety striking head
- High gloss polished
- Powder coated

“Standard“ version

- New improved quality
- Ground and polished
- Rounded edges
- Chrome vanadium steel
- Dip coated



Verbesserte Oberfläche der RENNSTEIG Splintentreiber

- geschliffene und polierte Oberfläche
- sehr geringe Oberflächen-Rauheit im Vergleich zum Wettbewerb (siehe Rauheitsprofile)
- Vorteile dieser Oberflächenbehandlung:
 1. geringere Korrosionsneigung des Splintentreibers
 2. kleinere Klemmgefahr bei der Anwendung
 3. höhere Biegebelastbarkeit (verbesserte Standzeiten und Elastizität)
 4. herstellungsbedingte Oberflächenkerben werden verschliffen und somit Sollbruchstellen nahezu ausgeschlossen

RENNSTEIG pin punches with improved surface finish

- Ground and polished
- Much less roughness than competitors (see roughness comparison below)
- Your benefits:
 1. Less prone to corrode
 2. Less likely to pinch during use
 3. Higher bending resilience (for longer service life and higher elasticity)
 4. Any surface nicks from forging are ground out, practically eliminating fracture points

Rauheitsprofile im Vergleich

Roughness comparison

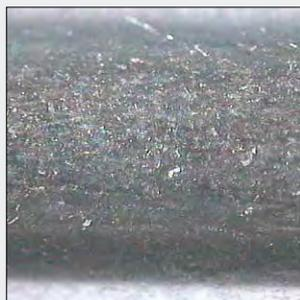
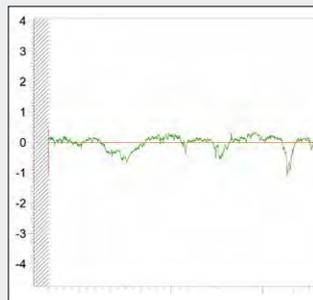

RENNSTEIG Splintentreiber
Ra: 0,15 μm , Rz: 0,92 μm
RENNSTEIG Pin Punch
Ra: 0.15 μm , Rz: 0.92 μm

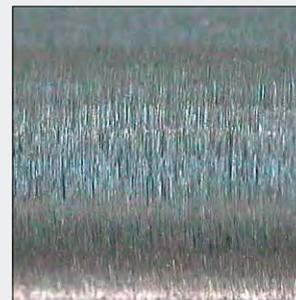
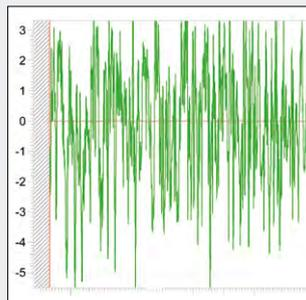

Splintentreiber Vergleichsprodukt
Ra: 1,53 μm , Rz: 11,13 μm
Comparable competitor pin punch
Ra: 1.53 μm , Rz: 11.13 μm

Ra Mittenrauwert, ist der arithmetische Mittelwert der Beträge aller Profilwerte des Rauheitsprofils

Rz Einzelrautiefe, ist der arithmetische Mittelwert von Einzelrautiefen aufeinanderfolgender Einzelmessstrecken. Die Einzelrautiefen ergeben sich aus der Summe der Höhe der größten Profilschuppe und der Tiefe des größten Profiltals innerhalb einer Einzelmessstrecke.

Ra Mean roughness, the arithmetic mean of all roughness profile values

Rz Individual roughness depth, the arithmetic mean of individual roughness depth of consecutive measurement samples. The individual roughness depths are the sum of the height of the highest peak and deepest valley within a measurement sample.

Splintentreibersätze

- Sätze ohne Handschutz 6 teilig, jeweils bestückt mit Ø 3 mm/4 mm/5 mm/6 mm/8 mm/10 mm
- wahlweise im Kunststoffhalter, in Kunststoffkassette oder Metallkassette
- Sätze mit Handschutz 5 teilig, jeweils bestückt mit Ø 2 mm/3 mm/4 mm/5 mm/6 mm nur in Kunststoffkassette
- Splintentreibersätze „Exklusiv“ rot oder mehrfarbig pulverbeschichtet, Splintentreibersätze „Standard“ gold tauchlackiert
- betroffene Werkzeuge entsprechen der DIN 6450

Sets of Parallel Pin Punches

- Sets of punches without handguard includes 6 pieces: dia. 3 mm/4 mm/5 mm/6 mm/8 mm/10 mm
- Choose between plastic stand, plastic case, or metal case
- Sets of punches with handguard includes 5 pieces: dia. 2 mm/3 mm/4 mm/5 mm/6 mm, only in plastic case
- “Exclusive” pin punches powder coated in different colours, “Standard” pin punches gold dip coated
- Affected tools comply with DIN 6450

Art. No.	Modell Model	Ausführung Version	Farbe Colour	Gewicht Weight g	VPE PU
425 560 6 RC	Kunststoffhalter Plastic stand	Exklusiv Exclusive	mehrfarbig multicoloured	520	1
425 560 6		Exklusiv Exclusive	rot red	520	1
425 170 0		Standard Standard	gold gold	520	1
425 500 6 RC	Kunststoffkassette Plastic case	Exklusiv Exclusive	mehrfarbig multicoloured	560	1
425 500 6		Exklusiv Exclusive	rot red	560	1
425 502 6		Exklusiv mit Handschutz Exclusive with handguard	rot red	570	1
425 150 0		Standard Standard	gold gold	560	1
425 152 0		Standard mit Handschutz Standard with handguard	gold gold	570	1
425 530 6 RC	Metallkassette Metal case	Exklusiv Exclusive	mehrfarbig multicoloured	740	1
425 530 6		Exklusiv Exclusive	rot red	740	1
425 160 0		Standard Standard	gold gold	740	1



Art. No. 425 170 0

Splintentreibersatz „Standard“
6-teilig in Kunststoffhalter
“Standard” pin punch set
in plastic stand



Art. No. 425 502 6

Splintentreibersatz „Exklusiv“
mit Handschutz
5-teilig in Kunststoffkassette
set of “Exclusive” pin punches
with handguard in plastic case



Art. No. 425 152 0

Splintentreibersatz „Standard“
mit Handschutz
5-teilig in Kunststoffkassette
set of “Standard” pin punches
with handguard in plastic case



Art. No. 425 530 6

Splintentreibersatz „Exklusiv“
6-teilig in Metallkassette
“Exclusive” pin punch set
in metal case

Splintentreiber

- Splintentreiber „Exklusiv“ pulverbeschichtet
- Splintentreiber „Standard“ gold tauchlackiert
- betroffene Werkzeuge entsprechen der DIN 6450



Art. No. 450 005 0

Splintentreiber „Standard“
„Standard“ pin punch



Art. No. 450 105 0

Splintentreiber „Standard“ mit Handschutz
„Standard“ pin punch with handguard



Art. No. 452 005 6

Splintentreiber „Exklusiv“
„Exclusive“ pin punch



Art. No. 452 105 6

Splintentreiber „Exklusiv“ mit Handschutz
„Exclusive“ pin punch with handguard

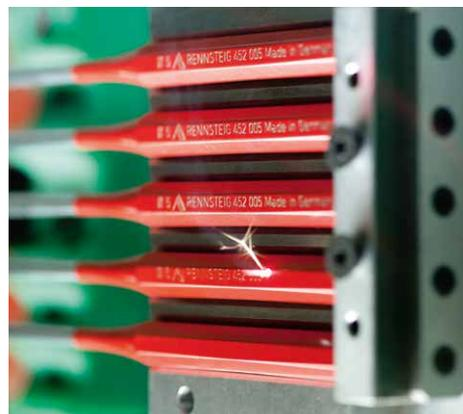

Beschriften der Splintentreiber mittels Lasertechnik
Laser marking pin punches

Parallel Pin Punches

- “Exclusive” pin punches powder coated
- “Standard” pin punches gold dip coated
- Affected tools comply with DIN 6450

Art. No.	Ø mm	 mm	Länge Length mm	Gewicht Weight g	VPE PU	 DIN 7255	
Splintentreiber „Standard“ „Standard“ pin punches							
450 002 0	2	10	150	65	10	•	
450 025 0	2,5	10	150	65	10	•	
450 003 0	3	10	150	70	10	•	
450 035 0	3,5	10	150	70	10	•	
450 004 0	4	10	150	70	10	•	
450 045 0	4,5	10	150	70	10	•	
450 005 0	5	10	150	75	10	•	
450 006 0	6	10	150	80	10	•	
450 007 0	7	12	150	110	10	•	
450 008 0	8	12	150	115	10	•	
450 009 0	9	12	150	120	10	•	
450 010 0	10	12	150	125	10	•	
451 010 0	10	14	150	130	10	•	
451 012 0	12	14	150	135	10	•	
451 014 0	14	16	150	175	10	•	
451 104 0	4	10	175	80	10	•	
451 105 0	5	10	175	90	10	•	
451 106 0	6	10	175	95	10	•	
451 108 0	8	12	175	110	10	•	
451 110 0	10	12	175	120	10	•	
Splintentreiber „Standard“ mit Handschutz „Standard“ pin punches with handguard							
450 102 0	2	10	150	79	5		
450 103 0	3	10	150	84	5		
450 104 0	4	10	150	84	5		
450 105 0	5	10	150	89	5		
450 106 0	6	10	150	94	5		
450 108 09	8	10	150	119	5		
Splintentreiber „Exklusiv“ rot „Exclusive“ pin punches, red							
452 002 6	2	10	150	65	10	•*	
452 003 6	3	10	150	70	10	•*	
452 004 6	4	10	150	70	10	•*	
452 005 6	5	10	150	75	10	•*	
452 006 6	6	10	150	80	10	•*	
452 008 6	8	12	150	115	10	•*	
452 010 6	10	12	150	125	10	•*	
Splintentreiber „Exklusiv“ rot mit Handschutz „Exclusive“ pin punches with handguard, red							
452 102 6	2	10	150	79	5		
452 103 6	3	10	150	84	5		
452 104 6	4	10	150	84	5		
452 105 6	5	10	150	89	5		
452 106 6	6	10	150	94	5		
Splintentreiber „Exklusiv“ mehrfarbig „Exclusive“ pin punches, multicoloured							
452 003 6 RC	3	gelb yellow	10	150	70	10	•*
452 004 6 RC	4	orange orange	10	150	70	10	•*
452 006 6 RC	6	grün green	10	150	80	10	•*
452 008 6 RC	8	hellblau light blue	12	150	115	10	•*
452 010 6 RC	10	dunkelblau dark blue	12	150	125	10	•*

* Härte Arbeitsende ≥ 58 HRC * Pin hardness ≥ 58 HRC

Splintentreiber mit Führungshülse

- Material: Chrom-Vanadium-Stahl
- Ausführung: zink-chromatiert
- Führungshülse kordiert, Treiberstift gehärtet
- Splintentreiber Ø 0,9 bis 3,9 mm mit loser Führungshülse
- Splintentreiber Ø 5,9 mm mit fester Hülse



Art. No. 457 009 5



verschiebbare Hülse
Sliding sleeve

Parallel Pin Punches with guide sleeve

- Chrome vanadium steel
- Zinc chromate
- Knurled guide sleeve, hardened punch pin
- Pin punches dia. 0.9 to 3.9 mm with loose guide sleeve
- Pin punch dia 5.9 mm with fixed sleeve

Art. No.	Ø mm	Mat Ø mm	Länge Length mm	Gewicht Weight g	VPE PU
457 009 5	0,9	6	80	15	10
457 014 5	1,4	6	84	15	10
457 018 5	1,8	6	88	15	10
457 024 5	2,4	8	92	25	10
457 028 5	2,8	8	96	25	10
457 034 5	3,4	8	98	25	10
457 039 5	3,9	8	100	25	10
457 059 5	5,9	8	102	30	10
457 100 5	Satz Splintentreiber in Metallkassette (8-teilig) Set in metal case (8-piece)				1
457 102 5	Satz Splintentreiber in Halterung (8-teilig) Set in stand (8-piece)				1



Art. No. 457 100 5



Art. No. 457 102 5

Splintentreiber XXL

- mit Handschutz
- poliert



Parallel Pin Punches XXL

- Handguard
- Polished

Art. No.	Ø mm	 mm	Länge Length mm	Gewicht Weight g	VPE PU
451 308 0	8	14	225	245	5
451 310 0	10	14	240	280	5
451 312 0	12	14	260	325	5
451 314 0	14	18	275	490	5
451 316 0	16	18	290	570	5
425 153 0	Satz 5-teilig im Karton <i>Set of 5 pieces in cardboard box</i>			1920	1
425 154 0	Satz 5-teilig im Koffer <i>Set of 5 pieces in case</i>			2520	1



Art. No. 425 154 0

Durchtreibersätze

- Durchtreibersätze bestückt mit
Ø 1 mm/2 mm/3 mm/4 mm/5 mm
und Körner Ø 4 mm
- Durchtreibersatz mit Handschutz bestückt mit
Ø 2 mm/3 mm/4 mm/5 mm/6 mm
- geschliffene und polierte Oberfläche
- abgerundete Kanten
- betroffene Werkzeuge entsprechen der DIN 6458

Taper Punch Sets

- Taper punch sets with
dia. 1 mm/2 mm/3 mm/4 mm /5 mm
and centre punch dia. 4 mm
- Set of taper punches with handguard
with dia. 2 mm/3 mm/4 mm/5 mm/6 mm
- Ground and polished surfaces
- Rounded edges
- Affected tools comply with DIN 6458



Art. No.	Ausführung Version	Gewicht Weight g	VPE PU
424 120 0	Durchtreibersatz im Kunststoffhalter Taper punch set in plastic stand	430	1
424 140 0	Durchtreibersatz in Kunststoffkassette Taper punch set in plastic case	460	1
424 130 0	Durchtreibersatz in Metallkassette Taper punch set in metal case	670	1
424 142 0	Durchtreibersatz mit Handschutz in Kunststoffkassette Set of taper punches with handguard in plastic case	570	1



Art. No. 424 120 0

Durchtreibersatz
in Kunststoffhalter
Taper punch set in
plastic stand



Art. No. 424 130 0

Durchtreibersatz
in Metallkassette
Taper punch set in
metal case



Art. No. 424 142 0

Durchtreibersatz mit Handschutz
in Kunststoffkassette, 5-teilig
Set of taper punches with handguard
in plastic case, 5-piece

Durchtreiber

- geschliffene und polierte Oberfläche
- abgerundete Kanten
- auch mit Handschutz erhältlich



Art. No. 440 003 0

Durchtreiber
Taper punch



Art. No. 440 103 0

Durchtreiber mit Handschutz
Taper punch with handguard

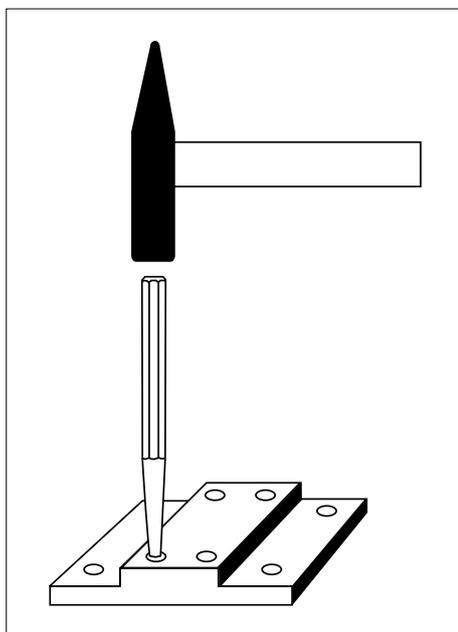

Taper Punches

- Ground and polished surfaces
- Rounded edges
- Also available with handguard

Art. No.	Ø mm	 mm	Länge Length mm	Gewicht Weight g	VPE PU	 DIN 7255
Form B nach DIN 6458 Type B per DIN 6458						
440 001 0	1	10	120	65	10	•
440 002 0	2	10	120	65	10	•
440 003 0	3	10	120	70	10	•
440 004 0	4	10	120	70	10	•
440 005 0	5	10	120	80	10	•
440 006 0	6	10	120	80	10	•
440 008 0	8	10	120	86	10	•
Form B mit Handschutz Type B with handguard						
440 102 0	2	10	120	79	5	
440 103 0	3	10	120	84	5	
440 104 0	4	10	120	84	5	
440 105 0	5	10	120	94	5	
440 106 0	6	10	120	94	5	
440 108 0	8	10	120	100	5	
Form D nach DIN 6458 Type D per DIN 6458						
441 001 0	1	12	120	85	10	•
441 002 0	2	12	120	85	10	•
441 003 0	3	12	120	90	10	•
441 004 0	4	12	120	90	10	•
441 005 0	5	12	120	95	10	•
441 006 0	6	12	120	100	10	•
441 007 0	7	12	120	105	10	•
441 008 0	8	12	120	110	10	•
441 009 0	9	12	120	130	10	•
441 010 0	10	12	120	135	10	•
443 009 0	9	12	150	150	10	•
443 010 0	10	12	150	150	10	•
Ergänzende Ausführungen Other versions						
444 103 0	12	14	150	180	10	•
444 108 0	10	16	150	180	10	•
444 109 0	12	16	150	200	10	•
444 110 0	14	16	150	220	10	•
444 112 0	12	16	175	250	10	•

**Ergonomisch können
mit variabler Handkraft**
*Ergonomic centre-punching
with adjustable hand force*



Art. No. 430 231
Art. No. 430 230
Art. No. 430 229



2-Komponenten-Handschutz

2-components-handguard



Einstellbare Schlagkraft

Adjustable striking force

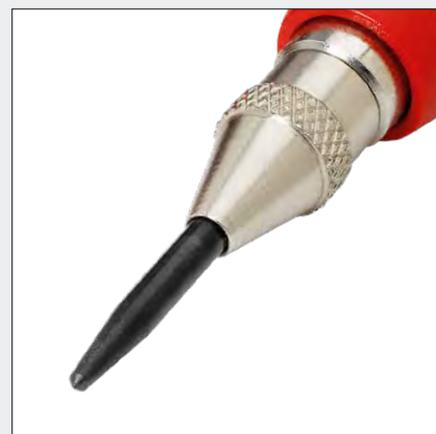

Austauschbare, gehärtete Spitze

Replaceable, hardened pin

Automatischer Körner

- selbstschlagend
- Präzisionsausführung
- mit auswechselbarer gehärteter Spitze
- Schlagkraft einstellbar
- Material: Stahl, Oberfläche galvanisiert
- mit 2-Komponenten-Handschutz erhältlich
- Auslieferung mit Euro-Loch-Aufhängung zur Präsentation an SB-Wänden



Art. No. 430 229



Art. No. 430 130

Mit der Größe des Körners nimmt die Schlagkraft zu. Daher empfehlen wir die Auswahl der Länge entsprechend der gegebenen Anwendung für feine Markierungen auf Stahl, NE-Metallen und Kunststoff bis zu kräftigen Markierungen auf Werkzeug- und Baustählen.

Automatic Centre Punch

- Rugged self striking mechanism activated by downward pressure
- Precision design
- Replaceable hardened pin
- Adjustable striking force
- Material: Steel, galvanized surface
- available with 2-components-handguard
- Delivered with euro slot hanger for presentations on self-service displays



Art. No.	Länge Length mm	Schaft Shank Ø mm	einstellbare Schlagkraft Adjustable striking force		Gewicht Weight g	VPE PU
			min N	max N		
430 129	95	11	20	50	30	1
430 229	95 HS				55	1
439 129	Ersatzspitze Ø 3,5 mm Spare pin dia. 3.5mm					1
430 130	125	14	60	130	65	1
430 230	125 HS				95	1
439 130	Ersatzspitze Ø 4 mm Spare pin dia. 4 mm					1
430 131	130	17	180	250	105	1
430 231	130 HS				140	1
439 131	Ersatzspitze Ø 6 mm Spare pin dia. 6 mm					1

HS: mit Handschutz
HS: with handguard

The punch's striking force increases with its size. We therefore recommend to select the size according to the given application for dot marking on steel, NF metals and plastics until robust marking of tool and structural steel.

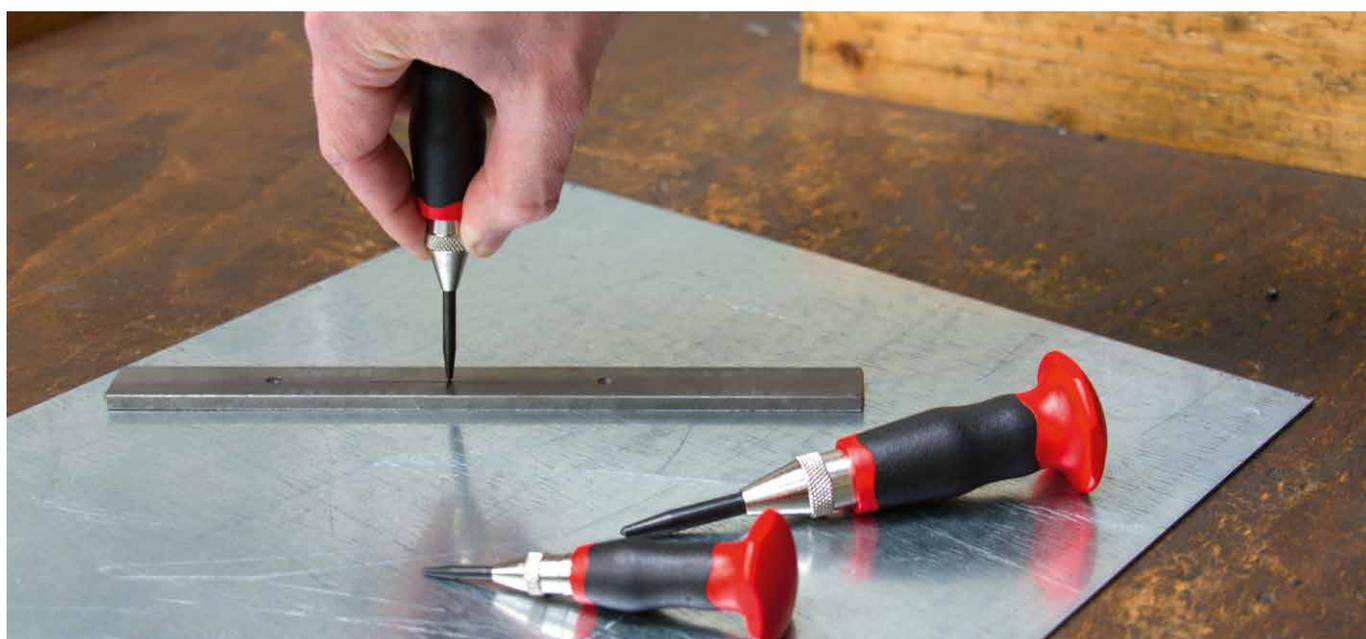

Zentrierkörner

- zum exakten, versatzfreien Körnen auf Werkstücken
- gleichmäßiges Ausrichten der geschlitzten Zentrierhülse am Musterwerkstück bzw. in einer Bohrschablone über Rändelschrauben
- spezialvergüteter, durchgehender Körnerstift
- nachschleifbar
- Material: Spezialwerkzeugstahl poliert



Art. No. 430 141

Adjustable Centering Punch

- For exact, offset-free centering on workpieces
- Perfect alignment of the slotted centering sleeve in the master or drilling jig with knurled screw
- Specially hardened and tempered passing centering punch
- Re grindable
- Material: special tool steel

Art. No.	Länge Length mm	Bohrung Hole Ø mm	Gewicht Weight g	VPE PU
430 140	95	6-8	20	1
430 140 00	Ersatzspitze Ø 6-8 mm Spare pin dia. 6-8 mm			1
430 141	105	8-11	37	1
430 141 00	Ersatzspitze Ø 8-11 mm Spare pin dia. 8-11 mm			1
430 142	115	11-16	78	1
430 142 00	Ersatzspitze Ø 11-16 mm Spare pin dia. 11-16 mm			1
430 143	Zentrierkörnerset 3-teilig 3 piece set			



Anpassbar an Bohrungsdurchmesser

Adjusts to fit hole diameter

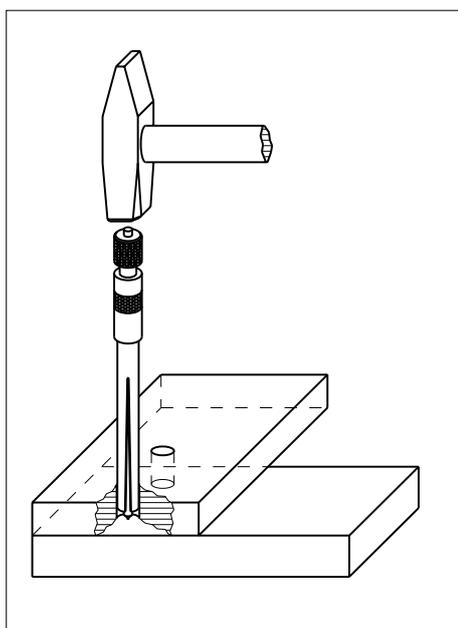

Übertragung von 2 Bohrungen auf eine Grundplatte

1. Verstellbaren Zentrierkörner einsetzen
2. Aufweiten der Zentrierhülse bis Zentrierlappen an Bohrungen anliegen
3. Mit Hammer auf Körnerstift schlagen

Transferring 2 holes onto a workpiece

- 1: Insert adjustable centering punch
- 2: Widen the centering sleeve until it fits the bore hole
- 3: Hit the centering punch with a hammer

Körner mit Hartmetallspitze

- Arbeitsende mit eingelöteter, präzise geschliffener Hartmetallspitze
- poliert



Art. No. 434 131 0

Centre Punch with carbide tip

- Working edge with brazed, precision ground carbide tip
- Polished

Art. No.	Ø mm	 mm	Länge Length mm	Gewicht Weight g	VPE PU
430 121 0	3	10	120	60	10
434 131 0	4	14	130	130	10

Körner

- geschliffene und polierte Oberfläche
- betroffene Werkzeuge entsprechen der DIN 7250



Art. No. 431 120 0



Art. No. 430 122 0
mit Handschutz
with handguard

Centre Punches

- Ground and polished
- Affected tools comply with DIN 7250

Art. No.	Ø mm	 mm	Länge Length mm	Gewicht Weight g	VPE PU	 DIN 7255
430 100 0	3	8	100	30	10	•
430 120 0	4	10	120	70	10	•
430 122 0	4	10	120, mit Handschutz 120, with handguard	84	5	
431 120 0	5	10	120	75	10	•
431 152 0	5	10	150, mit Handschutz 150, with handguard	134	5	
432 120 0	5	12	120	105	10	•
433 150 0	5	12	150	130	10	•
434 150 0	6	14	150	180	10	•
435 150 0	6	16	150	200	10	•

**Metall sicher und
effizient bearbeiten**
*Work metal safely
and efficiently*



Art. No. 381 241
Art. No. 320 250
Art. No. 392 003
Art. No. 393 003



- poliertes Blatt
- geschliffene Schneide
- optional poliert oder lackiert

- Polished blade
- Ground edge
- Polished or painted finish

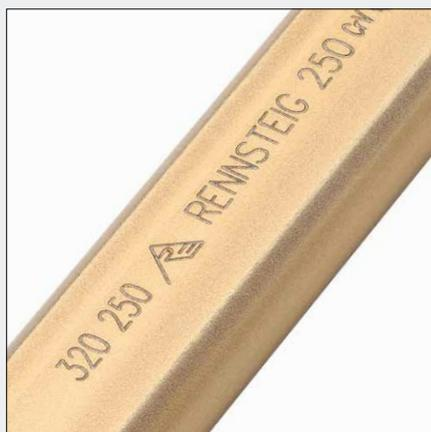

- hochwertige Lackierung, Laserkennzeichnung
- Quality painted finish with laser marking



- Know How unterm Lack:
vergüteter Sicherheitsschlagkopf
- Quality under the surface:
Tempered safety striking head

Flachmeißel

- bis Länge 500 mm gold-tauchlackiert
- größere Längen rot-pulverlackiert
- betroffene Werkzeuge entsprechen der DIN 6453



Art. No. 310 300 0



Art. No. 311 300 0

Flat Cold Chisels

- Sizes up to 500 mm gold dip-coated
- Larger sizes red powder-coated
- Affected tools comply with DIN 6453



Art. No. poliert polished	Art. No. lackiert painted	Länge Length mm	 mm	 mm	Gewicht Weight g	VPE PU	 DIN 7255
310 100 0	310 100 1	100	14 x 9	15	90	10	•
310 125 0	310 125 1	125	17 x 11	18	150	10	•
310 150 0	310 150 1	150	17 x 11	18	205	10	•
310 175 0	310 175 1	175	20 x 12	21	280	10	•
310 200 0	310 200 1	200	23 x 13	24	370	10	•
310 250 0	310 250 1	250	23 x 13	25	500	10	•
311 250 0	311 250 1	250 HS	23 x 13	25	605	10	•
310 300 0	310 300 1	300	23 x 13	26	600	5	•
311 300 0	311 300 1	300 HS	23 x 13	26	705	10	•
310 350 0	310 350 1	350	23 x 13	27	710	5	•
311 350 0	311 350 1	350 HS	23 x 13	27	815	10	•
310 400 0	310 400 1	400	23 x 13	27	935	5	•
310 500 0	310 500 1	500	26x 13	30	1160	5	•
	310 600 2	600	26 x 13	30	1340	5	•
312 125 0	312 125 1	125	 10	12	75	10	•
312 150 0	312 150 1	150	 10	12	90	10	•

HS: mit Handschutz

HS: with handguard

Kreuzmeißel

- betroffene Werkzeuge entsprechen der DIN 6451



Art. No. 320 300 0



Art. No. 321 300 0



Crosscut Chisels

- Affected tools comply with DIN 6451

Art. No. poliert polished	Art. No. lackiert painted	Länge Length mm	 mm	 mm	Gewicht Weight g	VPE PU	 DIN 7255
320 100 0	320 100 1	100	14 x 9	4	75	10	•
320 125 0	320 125 1	125	17 x 11	5	100	10	•
320 150 0	320 150 1	150	17 x 11	6	180	10	•
320 175 0	320 175 1	175	17 x 11	7	210	10	•
320 200 0	320 200 1	200	20 x 12	8	340	10	•
320 250 0	320 250 1	250	23 x 13	9	455	10	•
321 250 0	321 250 1	250 HS	23 x 13	9	560	10	•
320 300 0	320 300 1	300	23 x 13	9	600	5	•
321 300 0	321 300 1	300 HS	23 x 13	9	705	10	•
322 125 0	322 125 1	125	 10	4	65	10	•

HS: mit Handschutz

HS: with handguard

Werkzeuge für den Metallbereich *Metalworking Tools*

Schlitzmeißel

· für Stein- und Metallbearbeitung



Art. No. 380 240 0 / 381 240 0
Schlitzmeißel gerade
Slitting chisels, straight



Art. No. 380 241 0 / 381 241 0
Schlitzmeißel mit gebogenem Arbeitsende
Slitting chisel with offset tip

Trennstemmer



Art. No. 393 003 0

Nutenmeißel

· betroffene Werkzeuge entsprechen der DIN 6455



Art. No. 392 003 0



Slitting Chisels

· For stone and metal cutting

Art. No. poliert <i>polished</i>	Art. No. lackiert <i>painted</i>	Länge Length mm	 mm	 mm	Gewicht Weight g	VPE PU	 DIN 7255
Schlitzmeißel gerade <i>Slitting Chisels, straight</i>							
380 240 0	380 240 1	240	26 x 7	28	330	10	•
	380 240-1 1	240 SG	26 x 7	28	380	10	•
381 240 0	381 240 1	240 HS	26 x 7	28	435	10	•
Schlitzmeißel gebogen <i>Slitting Chisels, offset</i>							
380 241 0	380 241 1	240	26 x 7	27	330	5	•
381 241 0	381 241 1	240 HS	26 x 7	27	435	10	•

HS: mit Handschutz SG: mit Schutzgriff
HS: with handguard SG: with protection sleeve



Parting Chisels

Art. No. poliert <i>polished</i>	Länge Length mm	 mm	 mm	Gewicht Weight g	VPE PU	 DIN 7255
393 002 0	125	10	2	80	10	•
393 003 0	125	10	3	80	10	•
393 004 0	150	12	4	130	10	•
393 005 0	150	12	5	130	10	•

Grooving Chisels

· Affected tools comply with DIN 6455

Art. No. poliert <i>polished</i>	Art. No. lackiert <i>painted</i>	Länge Length mm	 mm	 mm	Gewicht Weight g	VPE PU	 DIN 7255
392 002 0	392 002 1	150	10	2	75	10	•
392 003 0	392 003 1	150	10	3	80	10	•
392 004 0	392 004 1	150	10	4	85	10	•
392 005 0	392 005 1	150	10	5	85	10	•
392 006 0	392 006 1	150	10	6	90	10	•

Werkzeugsatz

- wahlweise im Kunststoffhalter, in Kunststoffkassette oder Metallkassette
- Ausführung: poliert

Tool Set

- Choose from plastic stand, plastic case, or metal case
- Polished



Art. No.	Ausführung Version	Bestückung Contents	Gewicht Weight g	VPE PU
421 000 0	Kunststoffhalter Plastic stand	1 Flachmeißel 150 mm (Art. No. 312 150 0) 1 Flachmeißel 125 mm (Art. No. 312 125 0) 1 Kreuzmeißel 125 mm (Art. No. 322 125 0) 1 Körner Ø 4 mm (Art. No. 430 120 0) 1 Durchtreiber Ø 3 mm (Art. No. 440 003 0) 1 Durchtreiber Ø 4 mm (Art. No. 440 004 0)	470	1
421 001 0	Kunststoffkassette Plastic case	1 Flachmeißel 150 mm (Art. No. 312 150 0) 1 Flachmeißel 125 mm (Art. No. 312 125 0) 1 Kreuzmeißel 125 mm (Art. No. 322 125 0) 1 Körner Ø 4 mm (Art. No. 430 120 0) 1 Durchtreiber Ø 3 mm (Art. No. 440 003 0) 1 Durchtreiber Ø 4 mm (Art. No. 440 004 0)	500	1
421 002 0	Metallkassette Metal case	1 Flachmeißel 150 mm (Art. No. 312 150 0) 1 Flachmeißel 125 mm (Art. No. 312 125 0) 1 Kreuzmeißel 125 mm (Art. No. 322 125 0) 1 Körner Ø 4 mm (Art. No. 430 120 0) 1 Durchtreiber Ø 3 mm (Art. No. 440 003 0) 1 Durchtreiber Ø 4 mm (Art. No. 440 004 0)	700	1
421 102 0	Werkzeuge mit Handschutz in Kunststoffkassette Tools with handguard in plastic case	1 Flachmeißel 125 mm (Art. No. 312 126 0) 1 Kreuzmeißel 125 mm (Art. No. 322 126 0) 1 Körner Ø 4 mm (Art. No. 430 122 0) 1 Durchtreiber Ø 3 mm (Art. No. 440 103 0) 1 Durchtreiber Ø 4 mm (Art. No. 440 104 0) 1 Flat cold chisel 125 mm (Art. No. 312 126 0) 1 Crosscut chisel 125 mm (Art. No. 322 126 0) 1 Centre punch, dia. 4 mm (Art. No. 430 122 0) 1 Taper punch, dia. 3 mm (Art. No. 440 103 0) 1 Taper punch, dia. 4 mm (Art. No. 440 104 0)	585	1



Art. No. 421 000 0
Werkzeugsatz in
Kunststoffhalter
Tool set in plastic stand



Art. No. 421 002 0
Werkzeugsatz in
Metallkassette
Tool set in metal case



Art. No. 421 102 0
Werkzeugsatz mit Handschutz
in Kunststoffkassette, 5-teilig
Tool set with handguards in
plastic case, 5-piece

Nietzieher

- geeignet für Nieten nach DIN 660/661/662/674
- Nietziehersatz 5-teilig im Kunststoffhalter bestehend aus:
Niet Ø 2 mm/3 mm/4 mm/5 mm/6 mm
- betroffene Werkzeuge entsprechen der DIN 6434



Art. No. 445 004 0



Art. No. 445 100 0
Nietziehersatz
Set of rivet setters

Rivet Setters

- For rivets conforming to DIN 660/661/662/674
- 5-piece rivet setter set in plastic stand, for rivet dia. 2 mm/3 mm/4 mm/5 mm/6 mm
- Affected tools comply with DIN 6434

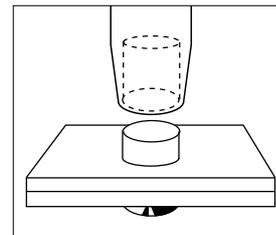

Art. No.	Niet Rivet Ø mm	Loch Hole Ø mm	mm	Länge Length mm	Gewicht Weight g	VPE PU	 DIN 7255
445 002 0	2	2.5	10	100	60	10	•
445 003 0	3	3.5	10	100	60	10	•
445 004 0	4	4.5	12	100	90	10	•
445 005 0	5	6	12	110	100	10	•
445 006 0	6	7	14	110	135	10	•
445 007 0	7	8	14	120	190	10	•
445 008 0	8	9	16	120	190	10	•
445 009 0	9	10	16	120	190	10	•
445 010 0	10	11	18	120	240	5	•
445 100 0	Nietziehersatz im Kunststoffhalter Set of Rivet Setters in plastic stand					1	

Nietkopfsetzer

- geeignet für Nieten nach DIN 660
- Nietkopfsetzersatz 5-teilig im Kunststoffhalter bestehend aus:
Niet Ø 2 mm/3 mm/4 mm/5 mm/6 mm
- betroffene Werkzeuge entsprechen der DIN 6435



Art. No. 446 004 0



Art. No. 446 100 0
Nietkopfsetzersatz
Set of rivet headers

Rivet Headers

- For rivets conforming to DIN 660
- 5-piece rivet header set in plastic stand, for rivet dia. 2 mm/3 mm/4 mm/5 mm/6 mm
- Affected tools comply with DIN 6435

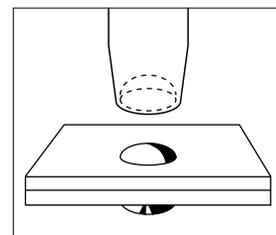

Art. No.	Niet Rivet Ø mm	Kopf Head Ø mm	mm	Länge Length mm	Gewicht Weight g	VPE PU	 DIN 7255
446 002 0	2	3.5	10	100	60	10	•
446 003 0	3	5.2	10	100	60	10	•
446 004 0	4	7	12	100	90	10	•
446 005 0	5	8.8	14	110	135	10	•
446 006 0	6	10.5	16	110	175	10	•
446 007 0	7	13	20	120	315	3	•
446 008 0	8	14	20	120	315	3	•
446 009 0	9	14.5	20	120	320	3	•
446 010 0	10	15	20	120	320	3	•
446 100 0	Nietkopfsetzersatz im Kunststoffhalter Set of rivet headers in plastic stand					1	

VerkaufsdDisplays Industrie und Handwerk

Display Nr. 2 – farbloses Acryl Display No. 2 – clear acrylic glass

Art. No. 429 201 + 429 201 0



Display Nr. 3 – farbloses Acryl Display No. 3 – clear acrylic glass

Art. No. 429 110 + 429 110 0



Sales displays for trade and industry



Art. No.	Artikel Article
429 201	Display Nr. 2, farbloses Acryl, ohne Bestückung Display No. 2, clear acrylic, empty
429 201 0	Bestückung für Display Nr. 2, poliertes Meißelblatt Assortment for Display No. 2, blade polished
429 201 1	Bestückung für Display Nr. 2, lackiertes Meißelblatt Assortment for Display No. 2, blade painted
429 110	Display Nr. 3, farbloses Acryl, ohne Bestückung Display No. 3, clear acrylic, empty
429 110 0	Bestückung für Display Nr. 3, poliertes Meißelblatt Assortment for Display No. 3, blade polished
429 110 1	Bestückung für Display Nr. 3, lackiertes Meißelblatt Assortment for Display No. 3, blade painted
429 611 0	Bestückung für Display Nr. M1, poliertes Meißelblatt Assortment for Display No. M1, blade polished

Bestückung der Displays Display contents

Art. No.	Artikel Article	Länge Length mm	Profil Profil	Display Nr. Display No.		
				2	3	M1
310 150 0/1*	Flachmeißel Flat cold chisels	150	17 x 11		6	
310 200 0/1*	Flachmeißel Flat cold chisels	200	23 x 13	5	6	
310 250 0/1*	Flachmeißel Flat cold chisels	250	23 x 13	5	6	
310 300 0/1*	Flachmeißel Flat cold chisels	300	23 x 13	5		
320 200 0/1*	Kreuzmeißel Crosscut chisels	200	20 x 12	5		
320 250 0/1*	Kreuzmeißel Crosscut chisels	250	23 x 13	5		
330 250 0/1*	Spitzmeißel Pointed chisels	250	16	5		
360 202 0/1*	Elektrikermeißel Electrician's chisels	200	8			10
361 202 0/1*	Elektrikermeißel Electrician's chisels	200	10	5		
361 252 0/1*	Elektrikermeißel Electrician's chisels	250	10	5		
360 252 0/1*	Elektrikermeißel Electrician's chisels	250	8		6	10
361 252 0/1*	Elektrikermeißel Electrician's chisels	250	10		6	
380 240 0/1*	Schlitzmeißel Slitting chisels	240	26 x 7		6	
385 060 0/1*	Fugenmeißel Jointing chisels	250	26 x 13	5		
421 000 0	Werkzeugsatz Tool set					1
430 100 0	Körner Centre punches	100	8		6	
430 120 0	Körner Centre punches	120	10	5	6	10
432 120 0	Körner Centre punches	120	10			10
424 120 0	Durchtreibersatz Set of paper punches					1
440 002 0	Durchtreiber Taper punches	120	10	5		10
440 003 0	Durchtreiber Taper punches	120	10	5		10
440 004 0	Durchtreiber Taper punches	120	10	5		10
440 005 0	Durchtreiber Taper punches	120	10	5		10
440 006 0	Durchtreiber Taper punches	120	10			10
440 008 0	Durchtreiber Taper punches	120	10			10
425 170 0	Splintentreibersatz Set of parallel pin punches					3
450 002 0	Splintentreiber Parallel pin punches	150	12	5	6	10
450 003 0	Splintentreiber Parallel pin punches	150	12	5	6	10
450 004 0	Splintentreiber Parallel pin punches	150	12	5	6	10
450 005 0	Splintentreiber Parallel pin punches	150	12	5	6	10
450 006 0	Splintentreiber Parallel pin punches	150	12		6	10
450 008 0	Splintentreiber Parallel pin punches	150	12		6	10
	Summe der Werkzeuge Total tools			90	89	160

* Art. No. xxx xxx 0: poliert, Art. No. xxx xxx 1: lackiert * Art. No. xxx xxx 0: polished, Art. No. xxx xxx 1: painted

**Extreme Standfestigkeit
durch Hartmetall-Wendeplatte**

*Replaceable carbide tip
for long life*



Art. No. 465 020 0
Art. No. 465 025 0
Art. No. 465 030 0



vierschneidige Hartmetallplatte

Four-edged carbide tip



Schneidplatte schnell auswechselbar

Cutting tip quickly replaceable



ergonomischer Griff

Ergonomic handle

Schaber

- schlanke ergonomische Bauweise
- verschleißfreie Pulverbeschichtung
- Wirkfläche geschliffen
- legierter Werkzeugstahl



Art. No. 465 030 0

Hartmetall-Flachscher
mit auswechselbarer, vierschneidiger,
Hartmetall-Wende-Schneidplatte
Carbide flat scraper with replaceable
four-blade reversible carbide tip



Art. No. 465 115 1

Hartmetall-Flachscher
mit eingelöteter Hartmetallplatte
mit doppelseitiger Bogenschneide
Carbide flat scrapers
with brazed carbide tip,
double sided, curved



Art. No. 460 100 0

Flachscher
Form A, ähnlich DIN 8350
Flat scrapers
Style A, similar to DIN 8350



Art. No. 463 260 09

aus 8-kant Chrom-Vanadium Stahl,
Schneide besonders flach geschmiedet
Chrome vanadium steel, octagonal shank,
very shallow forged scraper edge

Scrapers

- Slim, ergonomic shape
- Zero-wear powder coating
- Ground blade
- Alloy tool steel



Art. No.	Klingenlänge Blade length mm	 mm	Gewicht Weight g	VPE PU
Hartmetall-Flachscher Carbide flat scraper				
465 020 0	300	20 x 5	400	1
465 025 0	330	25 x 5	565	1
465 030 0	330	30 x 5	630	1
Ersatz-Hartmetall-Wende-Schneidplatten Replacement carbide tip				
465 020 0 0	25	20 x 2	16	1
465 025 0 0	25	25 x 2	20	1
465 030 0 0	25	30 x 2	24	1

Art. No.	Klingenlänge Blade length mm	 mm	Gewicht Weight g	VPE PU
Hartmetall-Flachscher Carbide flat scraper				
465 115 1	190	15 x 5	160	10
465 120 1	210	20 x 5	210	10
465 125 1	240	25 x 5	290	10
465 130 1	290	30 x 5	380	5

Art. No.	Klingenlänge Blade length mm	 mm	Gewicht Weight g	VPE PU
Flachscher Flat scraper				
460 100 0	100	20 x 5	95	10
460 150 0	150	20 x 5	140	10
460 175 0	175	20 x 5	155	10
460 200 0	200	20 x 5	170	10
460 250 0	250	25 x 6	300	10
460 300 0	300	25 x 6	320	10

Art. No.	Klingenlänge Blade length mm	 mm	Gewicht Weight g	VPE PU
Dichtungsschaber Seal scraper				
463 260 09	150	24	160	10

Schaber



Art. No. 461 100 0

Dreikantvollschaber,
Form B, ähnlich DIN 8350
Triangular scrapers,
Type B, similar to DIN 8350



Art. No. 462 100 0

Dreikantholschaber,
Form C, ähnlich DIN 8350
Triangular hollow-ground scrapers,
Type C, similar to DIN 8350



Art. No. 463 100 0

Löffelschaber
Spoon scrapers



Art. No. 464 100 0

Dreikantlöffelschaber
Triangular spoon scrapers



Scrapers

Art. No.	Klingenlänge Blade length mm	 mm	Gewicht Weight g	VPE PU
Dreikantvollschaber <i>Triangular scrapers</i>				
461 100 0	100	10	80	10
461 125 0	125	10	90	10
461 150 0	150	10	110	10
461 175 0	175	10	130	10
461 200 0	200	10	140	10

Art. No.	Klingenlänge Blade length mm	 mm	Gewicht Weight g	VPE PU
Dreikantholschaber <i>Triangular hollow-ground scrapers</i>				
462 100 0	100	14	80	10
462 125 0	125	14	90	10
462 150 0	150	14	100	10
462 175 0	175	14	120	10
462 200 0	200	16	140	10
462 250 0	250	16	185	10
462 300 0	300	16	245	10

Art. No.	Klingenlänge Blade length mm	 mm	Gewicht Weight g	VPE PU
Löffelschaber <i>Spoon scrapers</i>				
463 100 0	100	8	80	10
463 150 0	150	8	100	10
463 200 0	200	8	140	10
463 250 0	250	10	185	10
463 300 0	300	10	245	10

Art. No.	Klingenlänge Blade length mm	 mm	Gewicht Weight g	VPE PU
Dreikantlöffelschaber <i>Triangular spoon scrapers</i>				
464 100 0	100	8	95	10
464 125 0	125	8	100	10
464 150 0	150	8	120	10
464 200 0	200	10	140	10
464 250 0	250	10	180	10
464 300 0	300	10	230	10

PROFILIT Feinschaber

- dreischneidige Hohlprofilerschaber Klinge mit schwarzer Kunststoff-Schutzkappe
- schwarzer Kunststoffgriff



Art. No. 466 150 0



PROFILIT Precision Mechanic's Scraper

- Three-edged hollow profile scraping blade with black plastic protective cap
- Black plastic grip

Art. No.	Klingenlänge Blade length mm	 mm	Gewicht Weight g	VPE PU
PROFILIT Feinschaber <i>PROFILIT precision mechanic's scraper</i>				
466 150 0	25	8	40	10

Feinmechaniker-Schaber

- Schaber mit schlanker Dreikant-Hohlprofil Klinge aus Spezial-Feilenstahl



Art. No. 466 175 0



Precision Mechanic's Scraper

- With three-edged hollow profile blade of special file steel

Art. No.	Klingenlänge Blade length mm	 mm	Gewicht Weight g	VPE PU
Feinmechaniker-Schaber <i>Precision mechanic's scrapers</i>				
466 175 0	80	7	35	10

Lösehebel

- zum Lösen der Türverkleidungen in Kraftfahrzeugen
- schwarze Kunststoff-Pulverbeschichtung für besseren Gleiteffekt und zur Vermeidung von Beschädigungen lackierter Oberflächen



Art. No. 449 250 2

Release Lever

- To release door linings on vehicles
- Black powder-coating (PVC) for a better sliding performance and to avoid damages to lacquered surfaces

Art. No.	Blattbreite Blade width mm	Blattstärke Blade thickness mm	Nutbreite Notch width mm	 mm	Gewicht Weight g	VPE PU
Lösehebel <i>Release lever</i>						
449 250 2	26	2	7,4	10	145	10



**Schrauben ausdrehen –
für Rechts- und Linksgewinde**
**Remove damaged bolts,
for right or left-hand thread**

patentiert
patented



- Material: CrV-Stahl, gehärtet
- Oberfläche: brüniert, Schneidfläche poliert
- Of tempered CrV steel
- Black-oxide finish, polished cutting surface

Art. No. 471 005 3
Art. No. 471 003 3
Art. No. 471 001 3



Körnerfunktion
Center punch function



Doppelschneide –
abrutschsicherer zweischneidiger Eingriff in die zu
lösende Schraube bzw. den Gewindebolzen

Double edge –
slip-proof two-edge penetration in threaded fastener



6-kant Kopf
Hexagonal head

Schraubenausdreher

- für das beschädigungsfreie Ausdrehen von abgebrochenen Schrauben oder Gewindebolzen aus Gewindebohrungen – Retten hochwertiger Produkte



Art. No. 471 004 3

- zu entfernende Schraube mit passendem Bohrer vorbohren
- Ausdreher in das Bohrloch einschlagen und Schraube lösen
- Standzeit variiert in Abhängigkeit von der Härte des Gegenmaterials – ab einer bestimmten Härte des Gegenlaufes zum einmaligen Gebrauch bestimmt
- für Rechts- oder Linksgewinde verwendbar
- Drill hole in fastener with appropriate size drill bit
- Tap extractor into hole and loosen fastener
- Service life will depend on fastener material – on some fasteners it may not exceed one use
- For right or left-hand threads



Spannen des Schraubenausdrehers mittels Windeisen
Setting the extractor with a tap wrench



Art. No. 470 006 3

- zu entfernende Schraube mit passendem Bohrer vorbohren
- Ausdreher in die Bohrung eindrehen bis sich die Schraube löst und herausdrehen lässt
- nur für Rechtsgewinde geeignet
- Drill hole in fastener using appropriate size drill bit
- Turn extractor into hole until the fastener comes loose and can be unscrewed
- For right-hand thread only

Screw Extractors

- For damage-free removal of broken screws and bolts – Preserve high-value products



Art. No.	Größe Size	sw mm	Bohr Ø mm		Schrauben- größe		a/f inch	Drill dia. inch		Screw sizes inch		Gewicht Weight g	VPE PU
			min	max	min	max		min	max	min	max		
Schraubenausdreher zweischneidig Double-edged screw extractors													
471 001 3	1	6,35	3,2	4,8	M5	M6	1/4	1/8	3/16	3/16	1/4	8	1
471 002 3	2	9,5	4,8	7,1	M8	M10	3/8	3/16	1/4	5/16	3/8	18	1
471 003 3	3	12,7	6,4	9,5	M10	M12	1/2	1/4	3/8	7/16	1/2	35	1
471 004 3	4	15,9	9,5	12,7	M12	M16	5/8	3/8	7/16	1/2	9/16	57	1
471 005 3	5	19,0	11,1	15,9	M16	M20	3/4	7/16	9/16	5/8	3/4	87	1
471 006 3	6	22,0	14,3	19,1	M20	M24	7/8	9/16	3/4	7/8	1	130	1
471 007 3	7	25,4	19,1	23,8	-	M30	1	3/4	15/16	1	>1	203	1
471 900 3	Schraubenausdreher-Satz 5-teilig (Größe 1–5) in Kunststofftasche Screw extractor set 5 pieces (size 1–5) in vinyl pouch											230	1
471 901 3	Schraubenausdreher-Satz 5-teilig (Größe 1–5) in Metallkassette Screw extractor set 5 pieces (size 1–5) in metal case											430	1
471 903 3	Schraubenausdreher-Satz 3-teilig (Größe 1–3) in Kunststoff-Drehpack Screw extractor set 3 pieces (size 1–3) in plastic tube											62	1
471 904 3	Schraubenausdreher-Satz 5-teilig (Größe 1–5) in Kunststoff-Drehpack Screw extractor set 5 pieces (size 1–5) in plastic tube											236	1



Art. No. 471 904 3

Art. No. 471 901 3

Art. No. 470 902 3

Art. No.	Größe Size	Spitze Point Ø mm	Schaft Shank Ø mm	Länge Length mm	für Schrauben for fastener		Bohr Ø mm Drill dia. mm		Gewicht Weight g	VPE PU	
					min	max	min	max			
Schraubenausdreher „Spirale“ Spiral screw extractor											
470 001 3	1	1,75	3,6	50	M3	M6	2,0	3,5	3	10	
470 002 3	2	2,20	5,0	57	M6	M8	3,0	4,5	7	10	
470 003 3	3	3,30	6,5	64	M8	M11	4,0	6,0	13	10	
470 004 3	4	4,75	8,8	71	M11	M14	6,0	8,5	28	10	
470 005 3	5	6,35	11,0	78	M14	M18	7,0	11,0	48	10	
470 006 3	6	9,50	15,0	85	M18	M24	11,0	14,5	96	5	
470 007 3	7	12,70	19,0	92	M24	M33	14,5	19,0	165	5	
470 008 3	8	17,50	24,0	100	M33	M45	20,0	23,5	296	5	
470 900 3	Schraubenausdreher-Satz 5-teilig (Größe 1–5) in Kunststoff-Drehpack Screw extractor 5 piece set (size 1–5) in plastic tube									110	1
470 901 3	Schraubenausdreher-Satz 6-teilig (Größe 1–6) im Kunststoff-Drehpack Screw extractor 6 piece set (size 1–6) in plastic tube									218	1
470 902 3	Schraubenausdreher-Satz 8-teilig (Größe 1–8) im Kunststoff-Drehpack Screw extractor 8 piece set (size 1–8) in plastic tube									708	1

Kompromisslose Qualität: Werkzeuge für den Bau- und Montagebereich von RENNSTEIG.

Die Bauindustrie gehört in vielen Ländern zu den größten Arbeitgebern. Allein in Deutschland beschäftigt sie über zwei Millionen Erwerbstätige und erbringt ungefähr vier Prozent der Wertschöpfung. RENNSTEIG, einer der führenden Hersteller von Handwerkzeugen für diesen Industriezweig, ist seit Jahrzehnten sehr erfolgreich bei der Herstellung von funktionell und qualitativ hochwertigen Bau- und Montagewerkzeugen.

Das sehr umfangreiche Produktportfolio unseres Hauses reicht von Handschlagwerkzeugen wie Maurermeißel, Spitzmeißel, Fugenmeißel und Einschlaghilfen, bis hin zu Montagewerkzeugen wie Nageleisen, Montiereisen, Montagedornen, Winkeldornen und anderen. Sie sind neben Elektro- und Druckluftwerkzeugen unverzichtbare Arbeitsmittel im Hoch- und Tiefbau sowie im Ausbaugewerbe.

Für eine hohe Lebensdauer unserer Werkzeuge hat das Einhalten der DIN-Normen absolute Priorität. Dies gilt für technische Lieferbedingungen, Form und Ausführung sowie für die Auswahl des richtigen Materialprofils und der vorgeschriebenen Materialart. Ebenso wichtig ist die optimale Wärmebehandlung zur Sicherung hoher Standzeiten unserer Werkzeuge. Dennoch ist die Einhaltung der gültigen Arbeitsschutzbestimmungen (z.B. das Tragen einer Schutzbrille) durch den Anwender unerlässlich.

RENNSTEIG erfüllt hohen Qualitätskriterien, achtet auf ein ausgezeichnetes Oberflächenfinish und berücksichtigt individuelle Kundenwünsche bei der Farbgestaltung der Produkte. Dies begründet den Unterschied zum Wettbewerb und unterstreicht den Qualitätsbegriff „Werkzeuge – Made in Germany“.

Uncompromising quality: Tools for Construction and Installation from RENNSTEIG

In many areas, the construction industry is one of the most important employers. In Germany alone, it employs over two million people, and accounts for about four percent of GNP. RENNSTEIG is one of the leading suppliers of hand tools for the industry, and looks back over decades of a very successful production of functional, high-quality construction and installation tools.

Our extensive product line ranges from striking tools like masonry chisels, pointed chisels, jointing chisels and impact nail sets to assembly tools like wrecking bars, mounting bars, fitting plugs, angular assembly bars and more. They are indispensable in construction, civil engineering and renovation.

To ensure long service life we rigorously comply with DIN standards in finish, form, version and the choice of materials and cross-sections. The right tempering is also important in helping our tools stay on the job as long as possible. However, the user always needs to obey the relevant health and safety regulations, e.g. wearing of safety goggles.

RENNSTEIG meets the highest quality standards right down to the surface finish, and even meets individual customer colour preferences. All this makes the difference to the competition and underlines the quality of “Tools Made in Germany.”

Werkzeuge für den Bau- und Montagebereich *Tools for Construction and Installation*

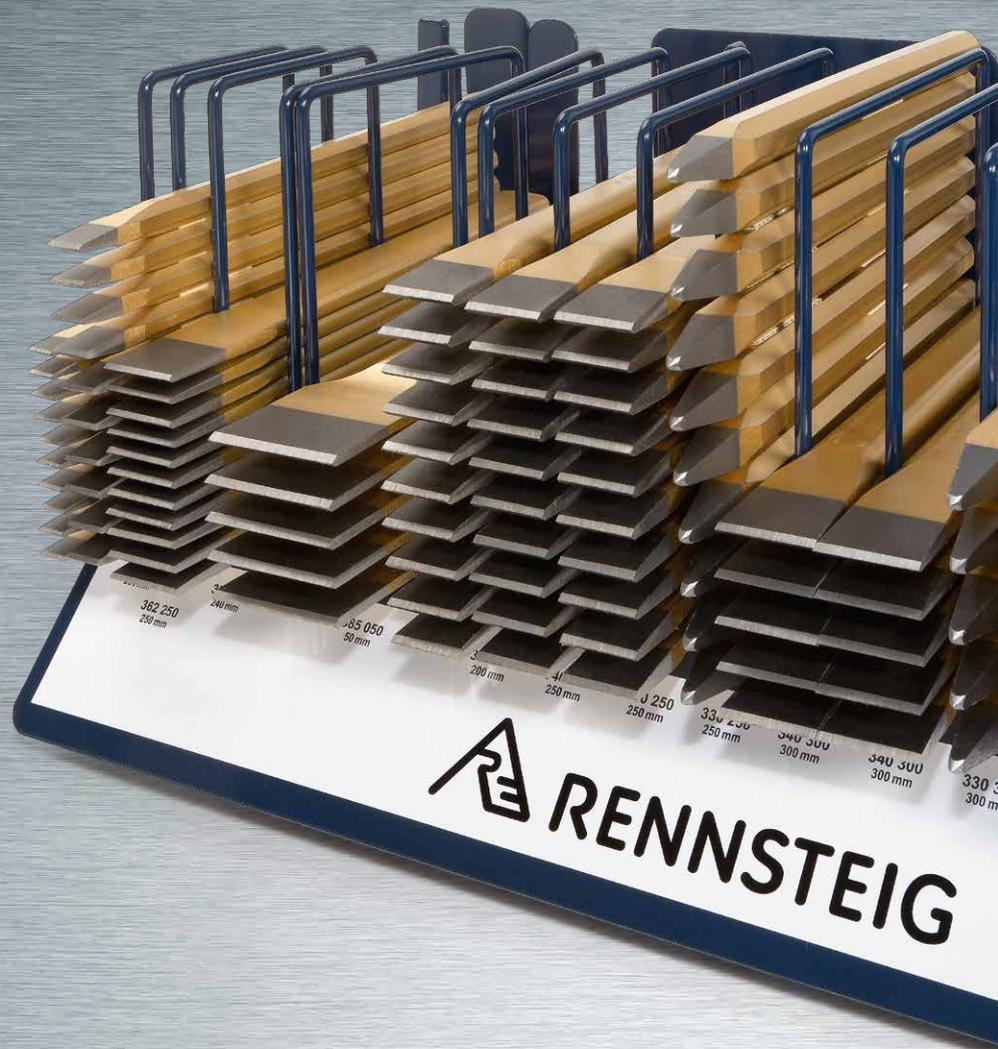
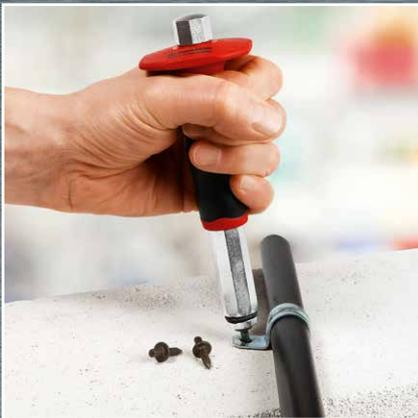
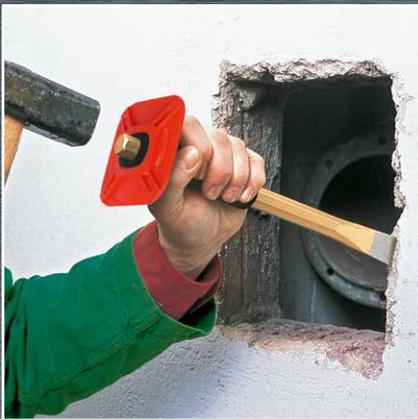

Für jeden Baustoff
den richtigen Meißel
*The right chisel
for any material*



Art. No. 386 050 0
Art. No. 340 300 0
Art. No. 330 300 0
Art. No. 361 253 0



- konisches Blatt verhindert Klemmen
- poliertes Blatt, geschliffene Schneide
- optional poliert oder lackiert

- Conical edge prevents binding
- Polished blade, ground edge
- Polished or lacquer finish



- hochwertige Lackierung, Laserkennzeichnung
- High quality lacquer finish, laser engraving



- Know How unterm Lack:
vergüteter Sicherheitsschlagkopf
- Quality under the surface:
Tempered safety striking head

Maurermeißel

- Profilmaterial: flach oval
- bis Länge 500 mm gold-tauchlackiert
- größere Längen rot-pulverlackiert
- betroffene Werkzeuge entsprechen der DIN 7254



Art. No. 340 300 0



Art. No. 341 300 0

Maurermeißel

- Profilmaterial: 8-kant



Art. No. 350 300 0



Art. No. 351 300 0



Schlitzmeißel

- für Stein- und Metallbearbeitung



Art. No. 380 240 0



Art. No. 381 240 0

Masonry Chisels

- Flat oval cross-section
- Sizes up to 500 mm gold dip-coated
- Larger sizes red powder-coated
- Affected tools comply with DIN 7254



Art. No. poliert <i>polished</i>	Art. No. lackiert <i>painted</i>	Länge Length mm	 mm	 mm	Gewicht Weight g	VPE PU	 DIN 7255
340 200 0	340 200 1	200	20 x 12	26	330	10	•
340 250 0	340 250 1	250	20 x 12	26	410	10	•
340 300 0	340 300 1	300	23 x 13	29	600	5	•
341 300 0	341 300 1	300 HS	23 x 13	29	705	10	•
340 350 0	340 350 1	350	23 x 13	29	720	5	•
341 350 0	341 350 1	350 HS	23 x 13	29	825	10	•
340 400 0	340 400 1	400	23 x 13	29	850	5	•
340 500 0	340 500 1	500	26 x 13	32	1230	5	•
rot pulverlackiert <i>red powder coated</i>							
	340 600 2	600	26 x 13	32	1340	5	•

HS: mit Handschutz HS: with handguard

Masonry Chisels

- Octagonal cross-section

Art. No. poliert <i>polished</i>	Art. No. lackiert <i>lacquered</i>	Länge Length mm	 mm	 mm	Gewicht Weight g	VPE PU	 DIN 7255
350 200 0	350 200 1	200	16	23	310	10	•
350 250 0	350 250 1	250	16	23	380	10	•
351 250 0	351 250 1	250 HS	16	23	485	10	•
350 300 09	350 300 19	300	16	26	420	5	•
350 300 0	350 300 1	300	18	26	460	5	•
351 300 0	351 300 1	300 HS	18	26	565	10	•
350 350 0	350 350 1	350	18	26	750	5	•
351 350 0	351 350 1	350 HS	18	26	855	10	•
350 400 09	350 400 19	400	18	28	900	5	•
350 400 0	350 400 1	400	20	30	1050	5	•
350 500 0	350 500 1	500	20	30	1300	5	•
rot pulverlackiert <i>red powder coated</i>							
	350 600 2	600	20	30	1500	5	•
	350 800 2	800	20	30	2020	2	•
	352 1000 2	1000	22	34	3140	2	•

HS: mit Handschutz HS: with handguard

Slotting Chisels

- For stone and metal cutting

Art. No. poliert <i>polished</i>	Art. No. lackiert <i>painted</i>	Länge Length mm	 mm	 mm	Gewicht Weight g	VPE PU	 DIN 7255
380 240 0	380 240 1	240	26 x 7	28	330	10	•
	380 240-1 1	240 SG	26 x 7	28	380	10	•
381 240 0	381 240 1	240 HS	26 x 7	28	435	10	•

HS: mit Handschutz HS: with handguard
SG: mit Schutzgriff SG: with protection sleeve

Spitzmeißel

- bis Länge 500 mm gold-tauchlackiert
- größere Längen rot-pulverlackiert
- betroffene Werkzeuge entsprechen der DIN 7256



Art. No. 330 300 0



Art. No. 331 300 0

Pointed Chisels

- Sizes up to 500 mm gold dip-coated
- Larger sizes red powder-coated
- Affected tools comply with DIN 7256

Art. No. poliert <i>polished</i>	Art. No. lackiert <i>painted</i>	Länge Length mm	 mm	Gewicht Weight g	VPE PU	 DIN 7255
330 200 0	330 200 1	200	16	300	10	•
330 250 0	330 250 1	250	16	365	10	•
331 250 0	331 250 1	250 HS	16	470	10	•
330 300 09	330 300 19	300	16	445	5	•
330 300 0	330 300 1	300	18	570	5	•
331 300 0	331 300 1	300 HS	18	675	10	•
330 350 0	330 350 1	350	18	675	5	•
331 350 0	331 350 1	350 HS	18	780	10	•
330 400 09	330 400 19	400	18	750	5	•
330 400 0	330 400 1	400	20	965	5	•
330 500 0	330 500 1	500	20	1235	5	•
	rot pulverlackiert <i>red powder coated</i>					
	330 600 2	600	20	1480	5	•
	330 800 2	800	20	2000	2	•
	332 1000 2	1000	22	3050	2	•

HS: mit Handschutz
HS: with handguard

Elektrikerspitzmeißel



Art. No. 361 255 0



Art. No. 361 256 0

Electrician's Pointed Chisels

Art. No. poliert <i>polished</i>	Art. No. lackiert <i>painted</i>	Länge Length mm	 mm	Gewicht Weight g	VPE PU	 DIN 7255
361 255 0	361 255 1	250	10	190	10	•
361 256 0	361 256 1	250 HS	10	210	10	
361 305 0	361 305 1	300	10	230	10	•
361 306 0	361 306 1	300 HS	10	250	5	

HS: mit Handschutz
HS: with handguard

Elektrikermeißel, 8-kant



Art. No. 361 252 0



Art. No. 361 253 0

Electrician's Chisels, octagonal

Art. No. poliert <i>polished</i>	Art. No. lackiert <i>painted</i>	Länge Length mm	 mm	 mm	Gewicht Weight g	VPE PU	 DIN 7255
360 202 0	360 202 1	200	8	10	98	10	•
360 252 0	360 252 1	250	8	10	120	10	•
360 302 0	360 302 1	300	8	10	130	10	•
361 202 0	361 202 1	200	10	12	140	10	•
361 203 0	361 203 1	200 HS	10	12	160	10	
361 252 0	361 252 1	250	10	12	190	10	•
361 253 0	361 253 1	250 HS	10	12	210	10	
361 302 0	361 302 1	300	10	12	230	10	•
361 303 0	361 303 1	300 HS	10	12	250	5	
362 202 0	362 202 1	200	12	14	220	10	•
362 252 0	362 252 1	250	12	14	260	10	•
362 302 0	362 302 1	300	12	14	330	10	•

HS: mit Handschutz
HS: with handguard

Elektrikerschlitzmeißel



Art. No. 366 250 0



Art. No. 367 250 0

Electrician's Slotting Chisels

Art. No. poliert <i>polished</i>	Art. No. lackiert <i>painted</i>	Länge Length mm	 mm	 mm	Gewicht Weight g	VPE PU	 DIN 7255
366 250 0	366 250 1	250	23 x 13	33	490	10	•
367 250 0	367 250 1	250 HS	23 x 13	33	595	10	•

Schlitzmeißel, 8-kant



Art. No. 382 300 0



Art. No. 383 300 0

Slotting Chisels, octagonal

Art. No. poliert <i>polished</i>	Art. No. lackiert <i>painted</i>	Länge Length mm	 mm	 mm	Gewicht Weight g	VPE PU	 DIN 7255
382 240 0	382 240 1	240	18	30	390	10	•
382 300 0	382 300 1	300	18	30	500	5	•
383 300 0	383 300 1	300 HS	18	30	605	10	•

HS: mit Handschutz

HS: with handguard

Fugenmeißel



Art. No. 385 060 0



Art. No. 386 050 0

Jointing Chisels

Art. No. poliert <i>polished</i>	Art. No. lackiert <i>painted</i>	Länge Length mm	 mm	 mm	Gewicht Weight g	VPE PU	 DIN 7255
385 050 0	385 050 1	250	23 x 13	50	550	5	•
	386 050 1	250 HS	23 x 13	50	655	10	•
385 060 0	385 060 1	250	26 x 13	60	570	5	•
	386 060 1	250 HS	26 x 13	60	675	10	•
385 070 0	385 070 1	250	26 x 13	70	590	5	•
	386 070 1	250 HS	26 x 13	70	695	10	•
	385 080 1	250	26 x 13	80	610	5	•
	386 080 1	250 HS	26 x 13	80	715	10	•

HS: mit Handschutz

HS: with handguard



Elektrikerschlitzmeißel
Electrician's slotting chisels



Schlitzmeißel, 8-kant
Slotting chisels, octagonal



Fugenmeißel
Jointing chisels

Fliesenmeißel



Art. No. 370 100 0



Art. No. 371 100 0

Handschutz



EURO-Halter aus Kunststoff

- Zur Präsentation von Handschlagwerkzeugen und Einsteckwerkzeugen für Elektrohämmer an SB-Wänden (SB-Selbstbedienung)
- bestückt oder unbestückt lieferbar



Floor Chisels

Art. No. poliert <i>polished</i>	Art. No. lackiert <i>painted</i>	Länge Length mm	mm	mm	Gewicht Weight g	VPE PU	DIN 7255
Fliesenmeißel, flach <i>Floor chisels, flat</i>							
370 100 0	370 100 1	100	8	10	55	10	•
370 125 0	370 125 1	125	10	12	100	10	•
Fliesenmeißel, spitz <i>Floor chisels, pointed</i>							
371 100 0	371 100 1	100	8		55	10	•
371 125 0	371 125 1	125	10		100	10	•



Handguards

Art. No.	Länge Length mm	mm	mm	Gewicht Weight g	VPE PU
Universal Handschutz für Flachprofile und 8-kant-Material, schwarz <i>Universal handguard for flat or octagon shank, black</i>					
395 110	110	16-18	20 x 12 bis to 23 x 13	105	1
Zwei-Komponenten-Handschutz <i>Two-component handguard</i>					
395 120	75	10	-	15	1
395 121	95	14	-	50	1
395 122	95	18	-	50	1
395 311	110	-	23 x 13	85	1
395 312	110	-	26 x 7	85	1
395 313	110	16	-	85	1
395 314	110	18	-	85	1
395 315	110	-	20 x 12	85	1
395 316	110	-	26 x 13	85	1

Plastic EURO Holders

- For presenting of hand striking tools and shank chisels for electric hammers in DIY-markets (SB-selfservice)
- Available with or without tools



Art. No.	Materialprofil <i>Cross section</i>			Bestell-Hinweis <i>Ordering information</i>
	mm	mm	mm	
395 212	14 x 9			Bei bestückten EURO-Haltern ist der Art. No. des jeweiligen Handschlagwerkzeuges ein „SB“ anzuhängen. Bestellbeispiel: Art. No. 310 300 0 SB Flachmeißel 300 mm pol. Blatt (23 x 13 mm) mit EURO-Halter Art. No. 395 215 EURO-Halter unbestückt für Profil (23 x 13 mm) <i>For tools with fixed EURO-holder, add "SB" to the Art. No. of the respective hand striking tool.</i> Example: Art. No. 310 300 0 SB Flat Chisel 300 mm pol. blade (23 x 13 mm) with EURO-holder, Art. No. 395 215 EURO-holder only, for cross section (23 x 13 mm)
395 213	17 x 11			
395 214	20 x 12			
395 215	23 x 13			
395 216	26 x 13			
395 217	26 x 7			
395 218		8		
395 219		10		
395 220		12		
395 221		16		
395 222		18		
395 223		20		
395 224			10	
395 225			18	

Verkaufsdисplays Bau und Montage

Display Nr. 1 – farbloses Acryl Display No. 1 – clear acrylic glass

Art. No. 429 101 + 429 101 0



Display Nr. 2 – farbloses Acryl Display No. 2 – clear acrylic glass

Art. No. 429 201 + 429 201 0



Construction and Installation Tool Displays



Art. No.	Artikel Article
429 101	Display Nr. 1, farbloses Acryl, ohne Bestückung Display No. 1, clear acrylic, empty
429 101 0	Bestückung für Display Nr. 1, poliertes Meißelblatt Assortment for Display No. 1, blade polished
429 101 1	Bestückung für Display Nr. 1, lackiertes Meißelblatt Assortment for Display No. 1, blade painted
429 201	Display Nr. 2, farbloses Acryl, ohne Bestückung Display No. 2, clear acrylic, empty
429 201 0	Bestückung für Display Nr. 2, poliertes Meißelblatt Assortment for Display No. 2, blade polished
429 201 1	Bestückung für Display Nr. 2, lackiertes Meißelblatt Assortment for Display No. 2, blade painted
429 601 0	Bestückung für Display Nr. M2, poliertes Meißelblatt Assortment for Display No. M2, blade polished
429 601 1	Bestückung für Display Nr. M2, lackiertes Meißelblatt Assortment for Display No. M2, blade painted

Bestückung der Displays Display contents

Art. No.	Artikel Article	Länge Length mm	Profil Profil	Display Nr. Display No.		
				1	2	M2
310 200 0/1*	Flachmeißel Flat cold chisels	200	23 x 13		5	
310 250 0/1*	Flachmeißel Flat cold chisels	250	23 x 13		5	
310 300 0/1*	Flachmeißel Flat cold chisels	300	23 x 13		5	
320 200 0/1*	Kreuzmeißel Crosscut chisels	200	20 x 12		5	
320 250 0/1*	Kreuzmeißel Crosscut chisels	250	23 x 13		5	
330 200 0/1*	Spitzmeißel Pointed chisels	200	16	5		
330 250 0/1*	Spitzmeißel Pointed chisels	250	16	5	5	10
330 300 0/1*	Spitzmeißel Pointed chisels	300	18	5		10
330 350 0/1*	Spitzmeißel Pointed chisels	350	18			5
330 400 0/1*	Spitzmeißel Pointed chisels	400	20			5
340 200 0/1*	Maurermeißel Mason's chisels	200	20 x 12			10
340 250 0/1*	Maurermeißel Mason's chisels	250	20 x 12			20
340 300 0/1*	Maurermeißel Mason's chisels	300	23 x 13			10
340 350 0/1*	Maurermeißel Mason's chisels	350	23 x 13			5
340 400 0/1*	Maurermeißel Mason's chisels	400	23 x 13			5
350 200 0/1*	Maurermeißel Mason's chisels	200	16	5		
350 250 0/1*	Maurermeißel Mason's chisels	250	16	5		
350 300 0/1*	Maurermeißel Mason's chisels	300	18	5		
360 202 0/1*	Elektrikermeißel Electrician's chisels	200	8			10
361 202 0/1*	Elektrikermeißel Electrician's chisels	200	10		5	
361 252 0/1*	Elektrikermeißel Electrician's chisels	250	10		5	
362 252 0/1*	Elektrikermeißel Electrician's chisels	250	12			10
380 240 0/1*	Schlitzmeißel Slitting chisels	240	26 x 7			10
385 050 0/1*	Fugenmeißel Jointing chisels	250	23 x 13			5
385 060 0/1*	Fugenmeißel Jointing chisels	250	26 x 13	5	5	
430 120 0	Körner Centre punches	120	10		5	
440 002 0	Durchtreiber Taper punches	120	10		5	
440 003 0	Durchtreiber Taper punches	120	10		5	
440 004 0	Durchtreiber Taper punches	120	10		5	
440 005 0	Durchtreiber Taper punches	120	10		5	
450 002 0	Splintentreiber Parallel pin punches	150	12		5	
450 003 0	Splintentreiber Parallel pin punches	150	12		5	
450 004 0	Splintentreiber Parallel pin punches	150	12		5	
450 005 0	Splintentreiber Parallel pin punches	150	12		5	
Summe der Werkzeuge Total tools				35	90	115

* Art. No. xxx xxx 0: poliert, Art. No. xxx xxx 1: lackiert

* Art. No. xxx xxx 0: polished, Art. No. xxx xxx 1: painted

**Robust und formstabil
für Abbruch und Montage**

*Made tough for
the tough jobs*



Art. No. 276 600 2
Art. No. 275 600 2



Klaue zum Entfernen von Nägeln, Hebelfunktion

Crowbar for leverage and pulling nails

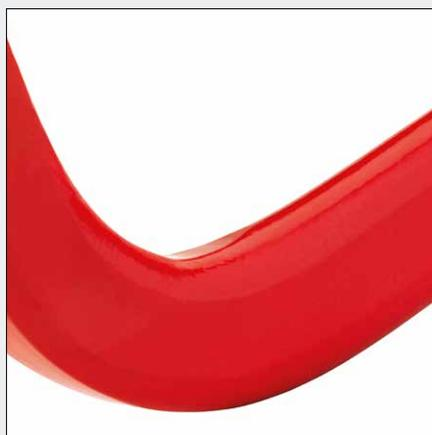

Profil flachoval - bis zu 50% erhöhtes
Widerstandsmoment gegen Verbiegen im Vergleich
zum 6-kant-Profil bei gleichem Gewicht

*Flat oval cross section - up to 50% higher bending
resistance vs hexagon cross section of same weight*



Meißelende zum Hebeln und Entschalen

Chisel end for levering and removing panels

Nageleisen

- Spezial-Werkzeugstahl, geschmiedet
- Arbeitsenden vergütet
- rot-pulverlackiert



Art. No. 275 600 2
ULTIMAX Nageleisen
ULTIMAX wrecking bars



Art. No. 276 600 2
Nageleisen flach-oval
Wrecking bar, flat-oval



Art. No. 271 600 2
Nageleisen 6-kant
Wrecking bar, hexagon



Art. No. 274 600 2
Nageleisen rund
Wrecking bar, round

Wrecking Bars

- Special tool steel, forged
- Quenched and tempered working edges
- Red powder coated



Art. No.	Länge Length mm	 mm	Gewicht Weight g	VPE PU
ULTIMAX Nageleisen <i>ULTIMAX wrecking bars</i>				
275 600 2	600	26 x 16	1900	1
275 800 2	800	26 x 16	2500	1
275 1000 2	1000	26 x 16	3100	1
Nageleisen flach-oval <i>Wrecking bars, flat-oval</i>				
276 400 2	400	20 x 12	800	1
276 500 2	500	20 x 12	1000	1
276 600 2	600	23 x 13	1400	1
276 800 2	800	23 x 13	1880	1
276 1000 2	1000	23 x 13	2650	1

Art. No.	Länge Length mm	 mm	Gewicht Weight g	VPE PU
Nageleisen 6-kant <i>Wrecking bars, hexagonal</i>				
271 400 2	400	18	1020	1
271 500 2	500	18	1240	1
271 600 2	600	18	1460	1
271 700 2	700	18	1700	1
271 800 2	800	18	1940	1
271 1000 2	1000	20	2880	1

Art. No.	Länge Length mm	 mm	Gewicht Weight g	VPE PU
Nageleisen rund <i>Wrecking bars, round</i>				
274 500 2	500	20	1400	1
274 600 2	600	20	1700	1
274 700 2	700	20	2300	1
274 800 2	800	20	2600	1
274 1000 2	1000	22	3200	1

Kistenbeitel

- Spezial-Werkzeugstahl, rot lackiert



Art. No. 279 300 1

Box Chisel

- Special tool steel, red coated

Art. No.	Länge Length mm	 mm	Gewicht Weight g	VPE PU
279 300 1	300	14	420	1

Richt-/Montiereisen

- Spezial-Werkzeugstahl, gehärtet, rot-pulverlackiert



Art. No. 273 600 2

Straightening/Mounting Bars

- Special tool steel, hardened, red powder coated

Art. No.	Länge Length mm	 mm	 mm	Gewicht Weight g	VPE PU
273 400 2	400	16	5	630	5
273 500 2	500	20	5	1050	5
273 600 2	600	20	5	1320	3

Winkeldorne

- Spezial-Werkzeugstahl, rund, rot-pulverlackiert
- Arbeitsenden vergütet



Art. No. 278 020 2

Angular Assembly Bars

- Special tool steel, round cross-section, red powder coated
- Quenched and tempered working edges

Art. No.	 mm	 mm	 mm	 mm	 mm	Gewicht Weight g	VPE PU
278 010 2	300	100	10	50	5	200	1
278 012 2	350	110	12	60	5	400	1
278 014 2	400	120	14	70	6	500	1
278 016 2	450	130	16	80	6	800	1
278 020 2	500	150	20	90	7	1500	1
278 026 2	550	170	26	100	8	2700	1

Montierspitze

- Spezial-Werkzeugstahl, lackiert
- gehärtet, Schlagkopf angelassen



Art. No. 449 500 1

Mounting Tool with Tip

- Special tool steel, painted
- Hardened, striking head tempered

Art. No.	Länge Length mm	 mm	 mm	 mm	Gewicht Weight g	VPE PU
449 500 1	500	20	170	5	1035	5

Brechstangen

- äußerst stabile Ausführung
- hochwertiger Werkzeugstahl, geschmiedet
- schwarz pulverlackiert
- Durchmesser 30 mm, Länge 1 m oder 1,50 m
- Arbeitsenden als Spitze, Klaue, oder Schneide, gerade oder gebogen
- Griffende wahlweise als Kugel erhältlich
- Einsatzbereiche: Bau, Demontage, Abriss, Zimmereien

Crowbars

- Extremely rugged construction
- High-quality tool steel, forged
- Black powder coated
- Length 1 m or 1.50 m, dia. 30 mm
- Tip, claw or blade shaped working edges, which can be straight or bent
- Round tool head available on request
- Fields of application: demolition works, in carpentry, on construction sites



Ausführungsbeispiele
Examples

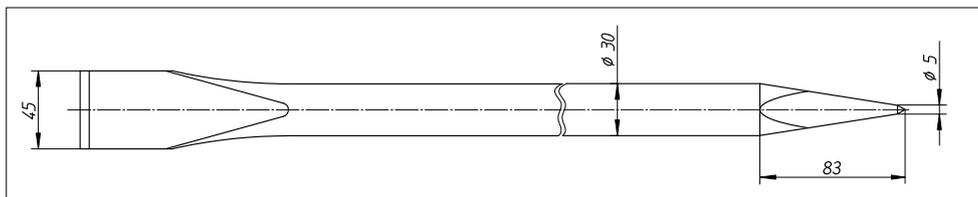

Art. No. 2732 1000 2 / 2732 1500 2
Schneide gerade, Spitze
straight edge, tip

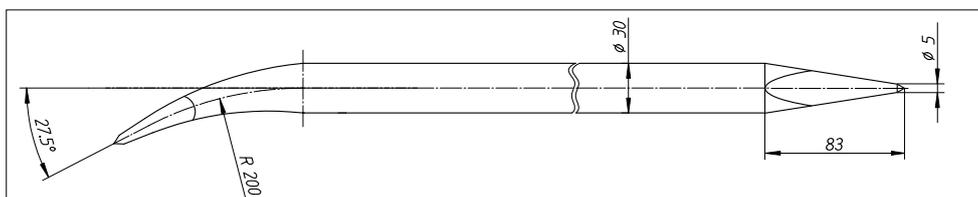

Art. No. 2731 1000 2 / 2731 1500 2
Schneide gebogen, Spitze
curved edge, tip

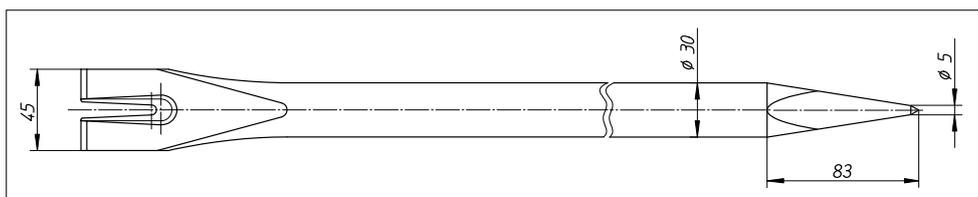

Art. No. 2734 1000 2 / 2734 1500 2
Klaue gebogen, Spitze
claw curved, tip

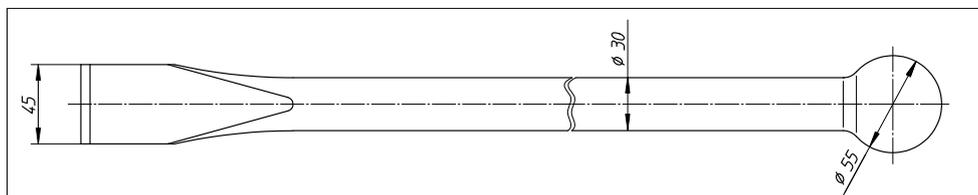

Art. No. 2735 1500 2
Schneide gerade, Kugelkopf
edge straight, ball-tip

Aufgrund der Größe und des Gewichtes gelten für die Brechstangen gesonderte Liefer- und Transportbedingungen.
Wir beraten Sie gern - telefonisch unter +49 3 68 47 / 4 41-0 oder per email unter info@rennsteig.com

Due to the size and weight of the crow bars certain special delivery and transporting instructions need to be considered.
We are glad to provide support - by telephone: +49 3 68 47/ 4 41-0 or via email: info@rennsteig.com

Durchschläge, Dorne

- Spezial-Werkzeugstahl, gehärtet, poliert
- Kegel geschliffen
- Schlagkopf angelassen



Art. No. 448 004 0
Montage Durchschlag
Assembly taper punch

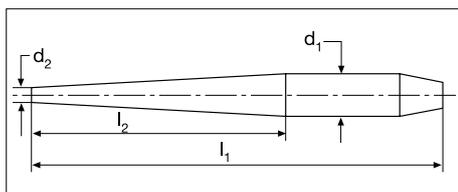

Art. No. 448 038 0
Montage Dorn
Assembly plug

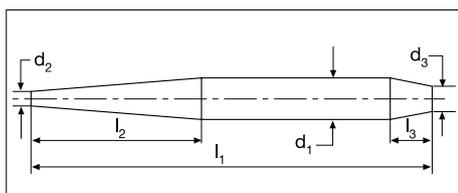

Taper Punches, Plugs

- Special tool steel, hardened, polished
- Cone polished
- Striking head tempered



Art. No.	d ₁ mm	l ₁ mm	l ₂ mm	d ₂ mm	Gewicht Weight g	VPE PU
Montage Durchschlag <i>Assembly taper punches</i>						
448 001 0	12	180	110	5	110	10
448 002 0	13	200	120	6	150	10
448 003 0	16	200	130	8	220	10
448 004 0	20	200	130	9	340	10
448 005 0	22	230	140	10	460	10
448 006 0	24	250	155	11	620	10
448 007 0	27	280	170	12	870	5
448 008 0	30	315	190	14	1260	5
448 009 0	32	340	200	15	1570	5
448 010 0	35	380	220	16	2230	5

Art. No.	d ₁ mm	l ₁ mm	l ₂ mm	l ₃ mm	d ₂ mm	d ₃ mm	Gewicht Weight g	VPE PU
Montage Dorn <i>Assembly plugs</i>								
448 031 0	11	120	50	15	5	8	75	10
448 032 0	13	120	50	15	5	9	90	10
448 033 0	15	150	60	15	6	10	165	10
448 034 0	17	170	60	20	7	12	240	10
448 035 0	19	170	60	20	7	14	300	10
448 036 0	21	190	70	20	8	15	410	10
448 037 0	23	190	70	20	9	16	485	5
448 038 0	25	200	80	25	10	18	585	5
448 039 0	28	210	80	25	12	20	805	5
448 040 0	30	230	90	30	12	22	1050	5
448 041 0	35	250	100	35	13	24	1345	5
448 042 0	35	270	110	40	14	26	1720	5

Beim Arbeiten mit Dornen und Durchschlägen ist unbedingt eine Schutzbrille zu tragen.
Bitte niemals auf das Arbeitsende schlagen!

*When working with taper punches and plugs, it is imperative to wear safety goggles.
NEVER strike the edge of the tool, only the head!*

Einschlaghilfe/Setzeisen

- Zum Befestigen von Schellen oder Bändern mit Hilfe von Einschlagnägeln direkt in Beton (ohne Vorbohren)



Art. No. 445 135 5



Art. No. 445 136 5



Art. No. 455 110 1



Art. No. 455 170 5 / 455 171 5



Impact Nail Set

- Knocks impact nails for conduit fixing clips or fixing bands directly into concrete (without pre-drilling)



Art. No.	Länge Length mm	 mm	Gewicht Weight g	VPE PU
445 135 5	135	14	120	10
445 136 5	135	14	120	10
455 110 1	110	12	100	10
455 170 5	170 HS	18	520	5
455 171 5	170 HS	18	520	5

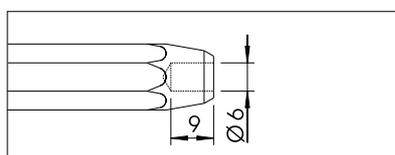

Art. No. 445 135 5

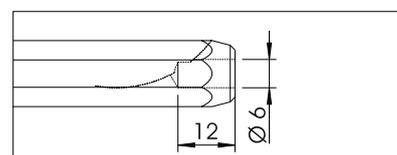

Art. No. 445 136 5

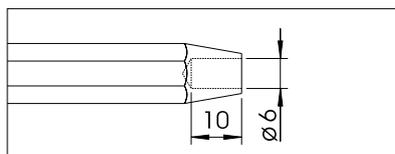

Art. No. 455 110 1

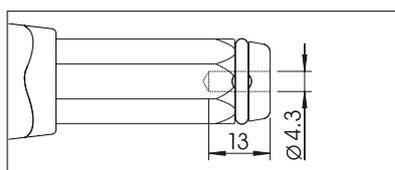

Art. No. 455 170 5

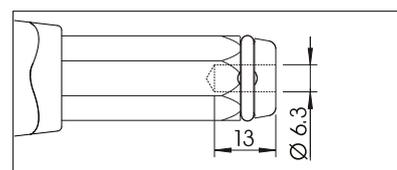

Art. No. 455 171 5

Für jedes Einsatzgebiet der Richtige: Meißel für Elektro- und Druckluftschläger von RENNSTEIG.

Neue Technologien und moderne Materialien bilden die Grundlagen für die stetige Entwicklung und Verbesserung von Elektro- und Druckluftschlägern. Kompaktere und leistungsfähigere Maschinen finden immer größere Anwendungs- und Einsatzbereiche. Heute werden Meißelschläger bei professionellen Arbeiten und auch im Heimwerk eingesetzt. Entsprechend steigen die Ansprüche an die Einsteckwerkzeuge.

Verschiedene Leistungsklassen der Meißelschläger sind wichtige Kriterien für die Form und Güte der Werkzeuge. Außerdem müssen spezielle Meißelaufnahmen verschiedenster Hersteller Berücksichtigung finden. Bei unseren Werkzeugen achten wir genau darauf, Materialien und Technologien bei der Herstellung anzupassen und Spezifikationen einzuhalten.

Die Arbeitsaufgaben und gewünschten Ergebnisse sind entscheidend für die Ausführung der Meißel. Abbruch von Beton oder Mauerwerk, Entfernen von Fliesen, Bearbeiten von Gestein oder Asphalt und Aufreißen von schweren Böden gehören zu den Einsatzgebieten eines Meißelhammers. Passend dazu werden verschiedene Einsteckwerkzeuge angeboten. Spitz-, Flach-, Spat- und Fliesenmeißel sind die gebräuchlichsten Meißelformen.

RENNSTEIG erfüllt einen hohen Qualitätsstandard. Durch den Einsatz hochwertigster Materialien sowie durch die Anwendung modernster Fertigungs- und Wärmebehandlungstechnologien werden Meißel für Elektro- und Druckluftschläger mit besten Gebrauchseigenschaften hergestellt. Eine Nachbearbeitung wie Schleifen und Schmieden ist problemlos möglich.

The right tool for the job: Chisels for Electric and Pneumatic Hammers from RENNSTEIG.

Like every technology, electric and pneumatic hammers are constantly getting better, more powerful, more compact, and more efficient. They are used in more and more areas - for professional and home jobs - and the demands made of these tools are rising accordingly.

Different performance classes of chisel hammers require different sizes and shapes of tools, and different manufacturers use different chucks. Our tools meet all requirements in terms of materials and technologies. They are available in different versions to cover different application areas and jobs.

Whether for demolishing concrete and masonry, removing tiles, working stone and asphalt, or ripping up heavy flooring, we provide the right tool for the job. Pointed, flat, spade and tile chisels are the most frequently used types.

RENNSTEIG meets the highest quality standards. We use only the best materials and the latest production and tempering techniques to build chisels for electric and pneumatic hammers that give top results. Our tools can be reground and reforged with ease.

Meißel für Elektro- und Druckluftschläger *Chisels for Electric and Pneumatic Hammers*



Meißel für Elektro- und Druckluftschläger *Chisels for Electric and Pneumatic Hammers*

Für jeden Hammer das richtige Werkzeug
The right bit for any hammer



Arbeitsende geschliffen

Ground tip



Komplett vergütet, Laserkennzeichnung

Fully tempered and laser engraved



Individuelles Einsteckende

Exact chuck fit



Anwendungsgebiete von Einsteckwerkzeugen

Shank chisel applications



Flachmeißel *Flat cold chisel*



- Für allgemeine Meißel- und Aufbrucharbeiten von Mauerwerk, Beton und losem Gestein
- Kleine Abschlagarbeiten
- Es wird eine gezielte Brechwirkung erreicht.

- For general chiseling and demolition jobs of brick, concrete and loose rocks
- Small removal jobs
- A precise breaking action is achieved.

Spitzmeißel *Pointed chisel*

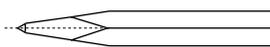

- Einsatz für allgemeine Meißel- und Abbrucharbeiten von Beton und harten Materialien

- For chiselling and demolition jobs on concrete and hard materials

Spatmeißel *Spade chisel*

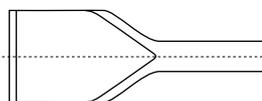

- Abschlagen von Putz an Wänden und Böden
- Entfernen von schweren Rostablagerungen
- Universell einsetzbar

- For removing plaster from walls and floors
- Removal of heavy rust layers
- Wide range of applications

Hohlmeißel *Grooving chisel*



- Einbringung von Nuten in Maueroberflächen für Elektro- und Sanitärinstallation
- Um eine lange Lebensdauer zu erreichen, sollte von Betonarbeiten abgesehen werden.

- For cutting grooves in wall surfaces for electric and plumbing lines
- Not designed for use on concrete

Kanalmeißel *Canal chisel*



- Einbringung von tieferen Nuten bzw. Kanälen in Mauerwerken für Elektro- und Sanitärinstallation
- Um eine lange Lebensdauer zu erreichen, sollte von Betonarbeiten abgesehen werden.

- For cutting deeper grooves or channels in brickwork for electric and plumbing installations
- Not designed for use on concrete

Flügelmeißel *Wing chisel*



- Einbringen von Nuten bzw. Kanälen in Mauerwerken für Elektro- und Sanitärinstallation
- Auflagefläche und Anstellwinkel des Meißels garantieren gleichmäßige Kanaltiefe.

- For cutting of grooves and channels in brickwork for electric and plumbing installations
- The bearing surface and angle of attack of the chisel give a uniform channel depth

Zahneisen *Toothed chisel*



- Für das Entfernen von Fugen- und Mauerputz
- Durchführung von leichten Meißelarbeiten, wie Ausstemmen von Nuten
- Universell einsetzbar

- For removing mortar and brickwork plaster
- Groove cutting
- Wide range of applications

Mörtelmeißel *Mortar chisel*



- Einsetzbar bei Reparaturarbeiten von Mauerwerken (Mörtelfugenausbesserung)
- Durch die Meißelgestaltung ist auch ein tiefes Eindringen in die Mörtelfuge möglich.

- For repairing defect mortar joints
- Deep access into the joints possible due to special chisel design

Fliesenmeißel *Floor chisel*



- Einsetzbar zum Abschlagen von Putz und Fliesen
- Durch die abgewinkelte Form des Meißelblattes ist ein schonendes und problemloses Arbeiten möglich

- For striking off plaster and tiles
- Trouble-free working thanks to the angled design of the chisel blade

Meißel für Elektro- und Druckluftschläger *Chisels for Electric and Pneumatic Hammers*

Meißel für Elektroschläger
SDS plus

Chisels for electric hammers
SDS plus

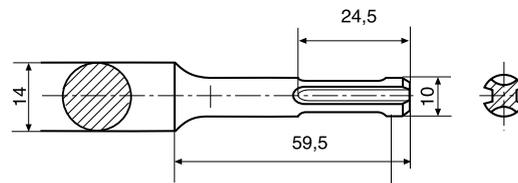

Arbeits-Ende Tip	Meißeltyp Type	Art. No.	Länge Length mm	Ø mm	Arbeits-Ende, Breite Tip width mm	Gewicht Weight g	VPE PU	Hersteller Infos Manufacturers
PCS-Meißel (SDS plus) - kurze Bauform <i>PCS-Chisels (SDS plus) - short form</i>								
	PCS-Flachmeißel <i>PCS-Flat cold chisels</i>	212 14000	140	14		20	120	10
	PCS-Spitzmeißel <i>PCS-Pointed chisels</i>	212 14001	140	14	-	105	10	
	PCS-Breitflachmeißel <i>PCS-Wide chisels</i>	212 14020	140	14		30	125	10
SDS plus-Meißel - mittlere Bauform <i>Chisels SDS plus - medium form</i>								
	Spatmeißel <i>Spade chisels</i>	212 17017	170	20		80	350	10
	Fliesenmeißel 20° abgewinkelt <i>Floor chisels</i> 20° offset	212 17018	170	20		80	340	10
SDS plus-Meißel - lange Bauform <i>Chisels SDS plus - long form</i>								
	Flachmeißel <i>Flat cold chisels</i>	212 25000	250	14		20	270	10
	Spitzmeißel <i>Pointed chisels</i>	212 25001	250	14	-	250	10	
	Hohlmeißel <i>Grooving chisels</i>	212 25003	250	16		22	300	10
	Zahneisen <i>Toothed chisels</i>	212 25005	250	14		20	270	10
	Fliesenmeißel 30° abgewinkelt <i>Floor chisels</i> 30° offset	212 25009	250	16		40	300	10
	Spatmeißel <i>Spade chisels</i>	212 25014	250	16		40	300	10
	Breitflachmeißel <i>Wide flat cold chisels</i>	212 25020	250	16		40	320	10
	Breitflachmeißel, gebogen <i>Wide flat cold chisels, offset</i>	212 25021	250	16		40	320	10

AEG
Black & Decker
BOSCH
DeWalt
Duss
HILTI
HITACHI
Kress
Makita
Metabo
Milwaukee
Sparky



Meißelsätze für Elektrohämmer SDS plus



Chisels for electric hammers SDS plus

Art. No.	Bestückung Contents	Gewicht Weight g	VPE PU
212 00090	1 Flachmeißel 250 mm (Art. No. 212 25000) 1 Spitzmeißel 250 mm (Art. No. 212 25001) 1 Spatmeißel 250 mm, 40 mm breit (Art. No. 212 25014) 1 flat chisel 250 mm (Art. No. 212 25000) 1 pointed chisel 250 mm (Art. No. 212 25001) 1 spade chisel 250 mm, 40 mm wide (Art. No. 212 25014)	850	1
212 00094	1 Flachmeißel 250 mm (Art. No. 212 25000) 1 Spitzmeißel 250 mm (Art. No. 212 25001) 1 Hohlmeißel 250 mm, 22 mm breit (Art. No. 212 25003) 1 flat chisel 250 mm (Art. No. 212 25000) 1 pointed chisel 250 mm (Art. No. 212 25001) 1 grooving chisel 250 mm, 22 mm wide (Art. No. 212 25003)	850	1
212 00096	1 PCS-Flachmeißel (Art. No. 212 14000) 1 PCS-Spitzmeißel (Art. No. 212 14001) 1 PCS-Breitflachmeißel (Art. No. 212 14020) 1 PCS-flat chisel (Art. No. 212 25000) 1 PCS-pointed chisel (Art. No. 212 25001) 1 PCS-Wide chisel (Art. No. 212 25014)	375	1



Meißelsätze für Elektrohämmer SDS max



Chisels for electric hammers SDS max

Art. No.	Bestückung Contents	Gewicht Weight g	VPE PU
210 00090	1 Flachmeißel 400 mm (Art. No. 210 40000) 1 Spitzmeißel 400 mm (Art. No. 210 40001) 1 Spatmeißel 400 mm, 50 mm breit (Art. No. 210 40002) 1 flat chisel 400 mm (Art. No. 210 40000) 1 pointed chisel 400 mm (Art. No. 210 40001) 1 spade chisel 400 mm, 50 mm wide (Art. No. 210 40002)	2300	1
210 00091	2 Flachmeißel 400 mm (Art. No. 210 40000) 1 Spitzmeißel 400 mm (Art. No. 210 40001) 1 Spatmeißel 400 mm, 50 mm breit (Art. No. 210 40002) 2 flat chisels 400 mm (Art. No. 210 40000) 1 pointed chisel 400 mm (Art. No. 210 40001) 1 spade chisel 400 mm, 50 mm wide (Art. No. 210 40002)	3000	1

Meißel für Elektro- und Druckluftschläger *Chisels for Electric and Pneumatic Hammers*

Meißel für Elektroschläger
SDS max

*Chisels for electric hammers
SDS max*

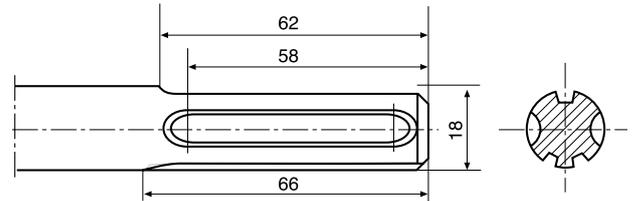

Arbeits-Ende Tip	Meißeltyp Type	Art. No.	Länge Length mm	Ø mm	Arbeits-Ende, Breite Tip width mm	Gewicht Weight g	VPE PU	Hersteller Infos Manufacturers
	Flachmeißel Flat cold chisels	210 28000	280	18		25	450	10
		210 40000	400	18		25	730	5
		210 60000	600	18		25	1100	5
	Spitzmeißel Pointed chisels	210 28001	280	18		-	450	10
		210 40001	400	18		-	680	5
		210 60001	600	18		-	1070	5
	Spatmeißel Spade chisels	210 30017	300	18		80	760	5
		210 40002	400	18		50	820	5
	Breitspatmeißel Wide chisels	210 35008	350	18		105	950	5
	Hohlmeißel Grooving chisels	210 30019	300	18		32	570	5
		210 30013	300	18		26	560	5
	Kanalmeißel Canal chisels	210 30007	300	18		32	680	5
	Zahneisen Toothed chisels	210 30005	300	18		32	550	5
	Mörtelmeißel Mortar chisels	210 30004	300	18		10	550	5
	Fliesenmeißel 20° abgewinkelt Floor chisels 20° offset	210 30015	300	18		50	560	5
		210 30018	300	18		80	610	5
	Flügelmeißel Wing chisels	210 38006	380	18		35	950	3

AEG
BOSCH
DeWalt
Duss
HILTI
HITACHI
ITW Spit-Impex
Kango
Kress
Makita
Metabo
Milwaukee
Sparky



Meißel für Elektrohämmer 6-kant 19 mm

Chisels for electric hammers 19 mm hexagon shank

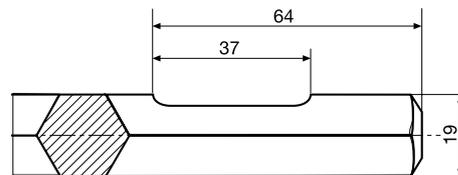

Arbeits-Ende Tip	Meißeltyp Type	Art. No.	Länge Length mm	mm	Arbeits-Ende, Breite Tip width mm	Gewicht Weight g	VPE PU	Hersteller Infos Manufacturers
	Flachmeißel Flat cold chisels	203 30000	300	19		25	650	5
		203 40000	400	19		25	900	5
	Spitzmeißel Pointed chisels	203 30001	300	19		-	650	5
		203 40001	400	19		-	850	5
	Hohlmeißel Grooving chisels	203 30019	300	19		22	650	5
	Spatmeißel Spade chisels	203 30002	300	19		50	700	5
		203 30017	300	19		80	700	3
		203 45002	450	19		50	1050	5
	Kanalmeißel Canal chisels	203 30007	300	19		26	750	5
		203 40007	400	19		26	1050	5
		203 50007	500	19		26	1350	3

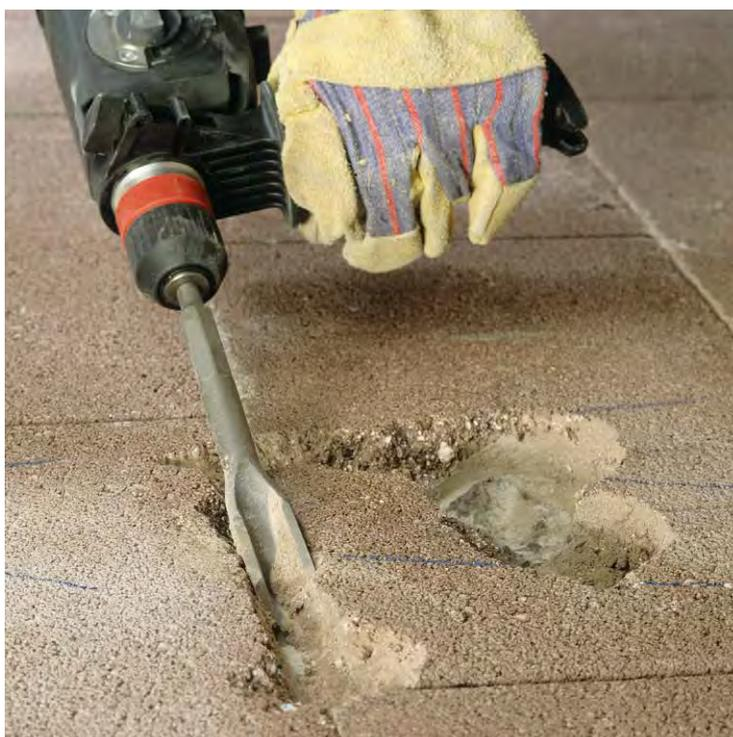

Meißel für Elektro- und Druckluftschläger *Chisels for Electric and Pneumatic Hammers*

Meißel für Elektroschläger
6-kant 29 mm

Chisels for electric hammers
Hexagonal, 29 mm

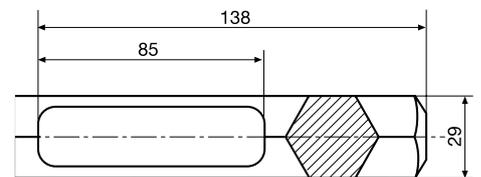

Arbeits-Ende Tip	Meißeltyp Type	Art. No.	Länge Length mm	mm	Arbeits-Ende, Breite Tip width mm	Gewicht Weight g	VPE PU	Hersteller Infos Manufacturers
	Flachmeißel Flat cold chisels	205 40000	400	29	35	2050	3	BOSCH DeWALT HITACHI Makita
	Spitzmeißel Pointed chisels	205 40001	400	29	-	1900	3	
	Spatmeißel Spade chisels	205 40017	400	29	80	3000	1	

Meißel für Elektroschläger
16,8x40 mm

Chisels for electric hammers
16.8x40 mm

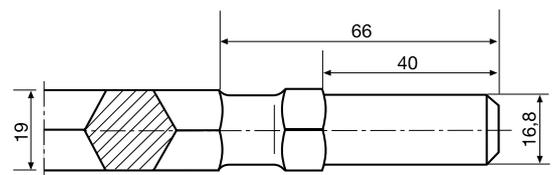

Arbeits-Ende Tip	Meißeltyp Type	Art. No.	Länge Length mm	mm	Arbeits-Ende, Breite Tip width mm	Gewicht Weight g	VPE PU	Hersteller Infos Manufacturers
	Flachmeißel Flat cold chisels	215 36000	360	19	25	760	5	HILTI
	Spitzmeißel Pointed chisels	215 36001	360	19	-	760	5	
	Spatmeißel Spade chisels	215 36002	360	19	50	900	5	



Meißel für Elektrohämmer 24 x 55 mm

Chisels for electric hammers 24 x 55 mm

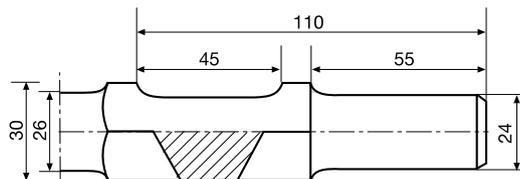

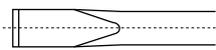
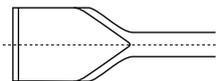
Arbeits-Ende Tip	Meißeltyp Type	Art. No.	Länge Length mm	 mm	Arbeits-Ende, Breite Tip width mm	Gewicht Weight g	VPE PU	Hersteller Infos Manufacturers
	Flachmeißel Flat cold chisels	227 40000	400	30	 35	1620	3	BOSCH Ferm HITACHI Makita RYOBI
	Spitzmeißel Pointed chisels	227 40001	400	30	-	1550	3	
	Spatmeißel Spade chisels	227 40017	400	30	 80	2000	3	

Meißel für Elektro- und Drucklufthämmer 29 x 152 mm

Chisels for electric and pneumatic hammers 29 x 152 mm

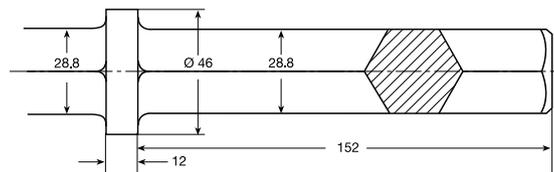

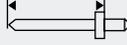
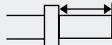
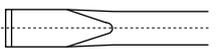
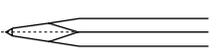
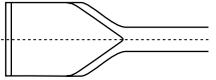
Arbeits-Ende Tip	Meißeltyp Type	Art. No.	 mm	 mm	 mm	Gewicht Weight g	VPE PU
	Flachmeißel Flat cold chisels	246 40000	400	29 x 152	30	2800	1
	Spitzmeißel Pointed chisels	246 40001	400	29 x 152	-	2800	1
	Spatmeißel Spade chisels	246 40017	400	29 x 152	80	3000	1

Hersteller Infos
Manufacturers

Airmatic
Atlas Copco
BOSCH

Böhler
Chicago
Compare

DeWALT
HITACHI
Ingersoll Rand

Irmer + Elze
Krupp
Lifton

Makita
Montabert
SIG

Thor Power Tools

Meißel für Elektro- und Druckluftschlämmer *Chisels for Electric and Pneumatic Hammers*

Meißel für Druckluftschlämmer
25 x 75 mm

Chisels for pneumatic hammers
25 x 75 mm

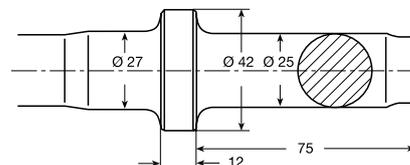

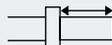
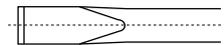
Arbeits-Ende Tip	Meißeltyp Type	Art. No.	 mm	 mm	 mm	Gewicht Weight g	VPE PU
	Flachmeißel Flat cold chisels	232 35000	350	25 x 75	25	1600	1
		232 50000	500	25 x 75	25	2200	1
		232 100000	1000	25 x 75	25	4200	1
	Spitzmeißel Pointed chisels	232 35001	350	25 x 75	-	1600	1
		232 50001	500	25 x 75	-	2200	1
		232 100001	1000	25 x 75	-	4200	1

Hersteller Infos
Manufacturers

- | | | | | |
|-------------|--------------------|----------------------------|------------------|------------------|
| Aerac2 | Deprac | Jagd- u. Sportwaffen Suhl | Maco Sullair | Spitznas |
| Airmatic | Ecoair (Flottmann) | Jenbacher Werke (Airquick) | Mannesmann Demag | Thor Power Tools |
| Atlas-Copco | Frölich & Klüpfel | Kaeser | Montabert | Vistarini |
| Böhler | Hausherr | Kent (Red-Line) | Premag (CP) | Wacker |
| Compair | Ingersoll Rand | Krupp | Scloverano | |
| Dehaco | Irmer & Elze | Maco-Meudon | SIG | |

Meißel für Druckluftschlämmer
25 x 108 mm

Chisels for pneumatic hammers
25 x 108 mm

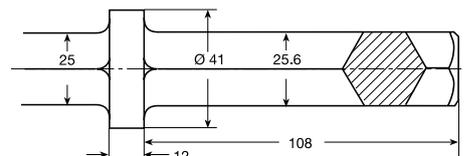

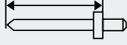
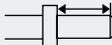
Arbeits-Ende Tip	Meißeltyp Type	Art. No.	 mm	 mm	 mm	Gewicht Weight g	VPE PU
	Flachmeißel Flat cold chisels	242 40000	400	25 x 108	30	2200	1
		242 50000	500	25 x 108	30	2800	1
	Spitzmeißel Pointed chisels	242 40001	400	25 x 108	-	2200	1
		242 50001	500	25 x 108	-	2800	1

Hersteller Infos
Manufacturers

- | | | | | |
|-------------|--------------------|----------------------------|------------------|------------------|
| Aerac2 | Deprac | Jenbacher Werke (Airquick) | Maco Sullair | SIG |
| Airmatic | Ecoair (Flottmann) | Kaeser | Mannesmann-Demag | Spitznas |
| Atlas-Copco | Frölich & Klüpfel | Kent (Red-Line) | Maruzen Kogyo | Stanley |
| Böhler | Hausherr | Krupp | Montabert | Thor Power Tools |
| Compair | Ingersoll Rand | Lifton | Premag (CP) | Vistarini |
| Dehaco | Irmer & Elze | Maco-Meudon | Scloverano | Wacker |



Meißel für Drucklufthämmer 32x152 mm

Chisels for pneumatic hammers 32x152 mm

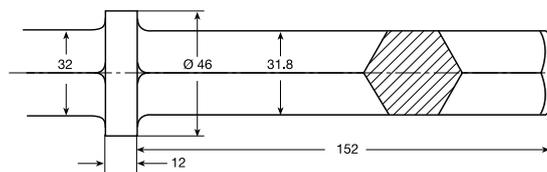

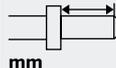
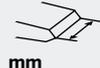
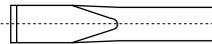
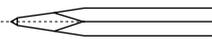
Arbeits-Ende Tip	Meißeltyp Type	Art. No.	 mm	 mm	 mm	Gewicht Weight g	VPE PU
	Flachmeißel Flat cold chisels	244 40000	400	32 x 152	35	3700	1
		244 50000	500	32 x 152	35	4300	1
		244 60000	600	32 x 152	35	5000	1
	Spitzmeißel Pointed chisels	244 40001	400	32 x 152	-	3700	1
		244 50001	500	32 x 152	-	4300	1
		244 60001	600	32 x 152	-	5000	1

Hersteller Infos Manufacturers

Airmatic
Atlas-Copco
Böhler
Compair
Dehaco
Deprag

Ecoair (Flottmann)
Frölich & Klüpfel
Hausherr
HITACHI
Ingersoll Rand
Irmer & Elze

Jagd- u. Sportwaffen Suhl
Jenbacher Werke (Airquick)
Kent (Red-Line)
Krupp
Lifton
Maco-Meudon

Mannesmann Demag
Maruzen Kogyo
Montabert
NPK
Premag (CP)
Sclaverano

SIG
Spitznas
Stanley
Thor Power Tools
Vistarini



Sie sind auf der Suche nach weiteren Meißelaufnahmen
und Meißelausführungen?
Sprechen Sie uns gern an – wir finden eine Lösung für Sie.

*Do you need a different chuck or chisel version?
Ask us. We'll find a solution!*

Meißel für Elektro- und Druckluftschläger *Chisels for Electric and Pneumatic Hammers*

Unsere Meißel wachsen
mit Ihren Anforderungen
*Chisels that
go the distance*

Länge bis zu 5 m
Up to 5 m long

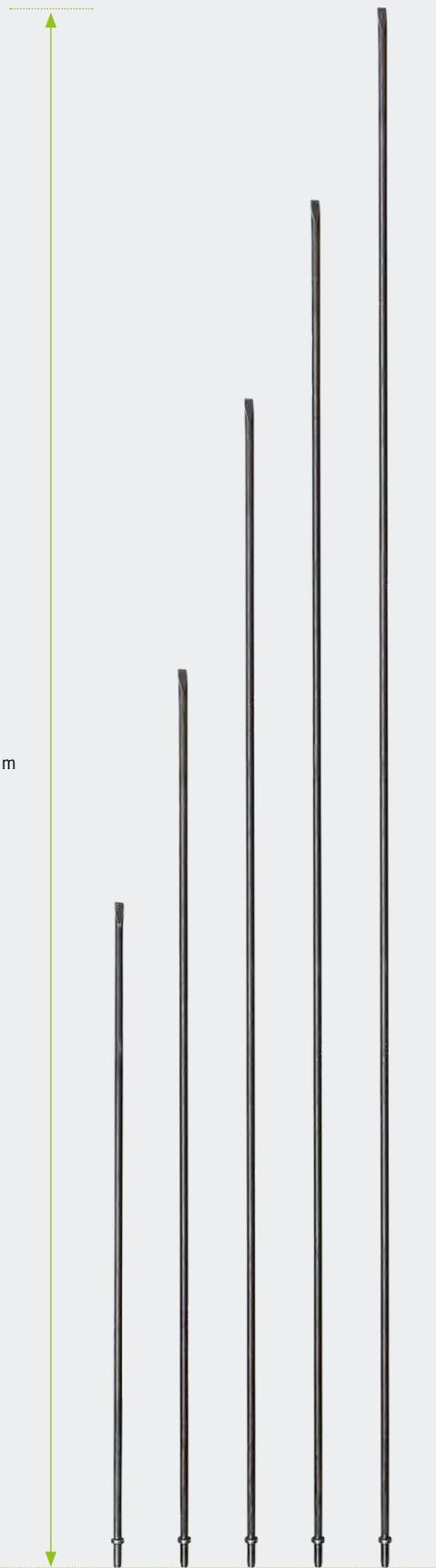

Arbeitsende flach
Flat tip



Arbeitsende spitz
Pointed tip



2 verschiedene Einsteckenden möglich
2 different insertion options



Nach Maß gefertigt: XXL-Meißel von RENNSTEIG.

Vor allem in Gießereien, sowie im Bau und Bergbau werden Meißel in Überlängen eingesetzt. Der Name „XXL-Meißel“ bringt die Größe dieser Produkte auf den Punkt, die für verschiedene Anwendungsbereiche und Spezialanwendungen unverzichtbar sind. Form und Größe der Meißel werden durch den Einsatzzweck bestimmt und angepasst.

RENNSTEIG verfügt über die technischen Voraussetzungen zur Herstellung von Meißeln in Überlängen. Dabei ist die größtmögliche Produktionslänge abhängig vom eingesetzten Material. Generell ist RENNSTEIG in der Lage, Maschinen- und Handmeißel bis zu einer Gesamtlänge von fünf Metern zu produzieren. Diese großen Meißel können mit zwei verschiedenen Einsteckenden angeboten werden.

Die Formen der Arbeitsenden sind ausschlaggebend und äußerst wichtig für den Einsatz der XXL-Meißel. Wir produzieren in den gebräuchlichsten Formen wie Spitz und Flach und liefern auf Wunsch auch Sonderformen entsprechend Ihren Anforderungen. Bitte kontaktieren Sie uns bezüglich der projektbezogenen Mindestabnahmemengen - wir beraten Sie gern.

RENNSTEIG bietet Ihnen natürlich auch einen XXL-Service. Unser Vertriebsteam steht mit fundiertem Wissen und einer bereits bestehenden Produktauswahl zur Verfügung. Spezielle Wünsche unterlegen wir mit einem spezifischen Angebot. Außerdem reparieren wir Ihre XXL-Meißel. Wir organisieren Abholung und Lieferung. Die Reparatur wird am Standort Altersbach nach entsprechenden Qualitätsparametern durchgeführt. Damit garantieren wir eine hohe Lebensdauer der instandgesetzten Produkte.

Made-to-order XXL Chisels from RENNSTEIG.

Over length chisels are often used in foundries, construction and mining. The name "XXL Chisel" already indicates the size of these products, which are indispensable for all kinds of different applications and special purposes. The shapes and sizes of the chisels are dependent on and adapted to their intended use.

RENNSTEIG has the technical capacities to manufacture over-sized chisels. The largest possible produced length of the chisels depends on the material used. Overall RENNSTEIG is able to produce machine and hand chisels up to a length of 5 meters. These large chisels are offered with two different insertion ends.

The choice of tip shape depends on the application determines, and we supply the most common tips such as pointed and flat, as well as other tips through special order. Please contact us for project-related minimum order quantities – we are glad to be of service.

RENNSTEIG naturally also offers XXL service. Our sales team has deep knowledge and an extensive product portfolio, backed up by the ability to meet special requests. We'll also repair your XXL chisels, and take care of pick-up and delivery. Repairs are done in our Altersbach facility to exact quality specifications for maximum service life.

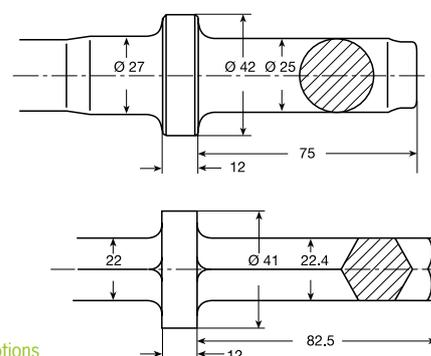

Induktives Härten der Meißel
Inductive tempering



XXL-Meißel im Einsatz
XXL chisel in use

Sie suchen eine individuelle Werkzeuglösung? Profitieren Sie von unserer Entwicklungskompetenz!

Are you looking for an individual tool solution? Benefit from our development expertise!

Mit RENNSTEIG steht Ihnen ein kompetenter Partner für neue, innovative und individuelle Werkzeuge zur Seite. Derzeit über 50 internationale Patente sind das Ergebnis der ständigen Suche nach immer neuen und besseren Lösungen. Unsere Experten aus Entwicklung, Werkzeugbau und Produktion setzen Ihre Wünsche und Ideen in ein ausgereiftes und voll einsatzfähiges Produkt um. Regler Informationsaustausch und die Einbindung unserer Kunden in die Entscheidungen des Entwicklungsprozesses sind dabei eine wichtige Voraussetzung für den Erfolg.

Unser umfangreicher kundenindividueller Service bietet Ihnen zahlreiche Möglichkeiten der Ausstattung und Kennzeichnung. Aufdrucke mit neuesten Lasern oder Printern sowie verschiedene Griff- und Farbvarianten geben Ihren Werkzeugen das individuell gewünschte Aussehen. Unser Team steht hierbei gern mit Rat und Tat zur Seite.

With RENNSTEIG you have an expert partner for new, innovative, individual tools. Our constant search for ever better and more efficient solutions has resulted in over 50 international patents. Our experts in development, toolmaking and production transform your wishes and ideals into practical, effective tools. A lively exchange of information and inclusion of our customers in development decisions are key elements in the success of this process.

Our comprehensive individual customer service offers many options in terms of features and markings. The latest laser engraving or printing technology, as well as different grip and colour versions, give your tools the unique appearance you're looking for. Our team will be glad to help you choose.

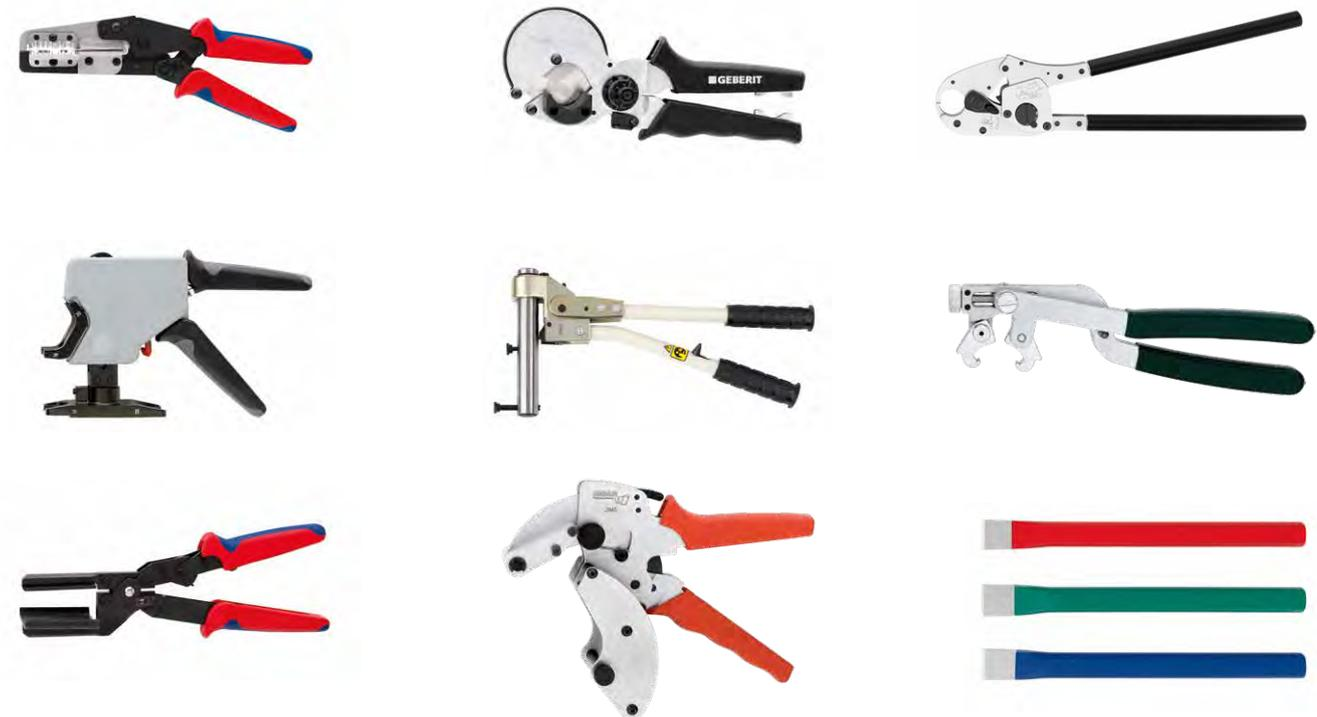

Eine repräsentative Auswahl unserer kundenindividuellen Produkte
A representative selection of our customer-specific products.



Kennen sie unsere Werkzeuge zur Kabelverarbeitung? *Are you familiar with our cable & connector tools?*



Schneiden
Cutting



Abisolieren
Stripping



Crimpen
Crimping

Qualitätswerkzeuge von RENNSTEIG zur Kabelverarbeitung werden weltweit eingesetzt. Das gesamte Sortiment finden Sie in unserem 114-seitigen Katalog.

Bestellen Sie Ihr persönliches kostenfreies Exemplar – telefonisch unter +49 3 68 47 / 4 41-0 oder per E-Mail an info@rennsteig.com

RENNSTEIG crimping and cable tools are used around the world. You'll find the entire range in our 114 page catalogue. Order your free copy today, by phone at +49 3 68 47 / 4 41-0 or by e-mail to info@rennsteig.com





Rennsteig Werkzeuge GmbH

An der Koppel 1
98587 Steinbach-Hallenberg
Germany

Telefon: +49 (0) 36847 / 4 41-0
Fax: +49 (0) 36847 / 4 41-14
E-Mail: info@rennsteig.com

www.rennsteig.com

RENNSTEIG im Internet



Find us on 

